

## GACAR PART 139 – CERTIFICATION, AUTHORIZATION AND OPERATION OF AERODROMES

### Table of Contents

|  |           |
|--|-----------|
| <b>SUBPART A – CERTIFICATION AND AUTHORIZATION.....</b>                              | <b>7</b>  |
| § 139.101 General.....   | 7         |
| § 139.103 Applicability .....  | 7         |
| § 139.105 Aerodrome Classification and Certification/Authorization Requirements..... | 7         |
| § 139.107 Person in Charge of the Aerodrome.....                                     | 9         |
| § 139.109 Aerodrome Management Personnel.....  | 9         |
| § 139.111 Prohibition of the Problematic Use of Psychoactive Substances.....         | 10        |
| § 139.113 Specific procedures for Aerodrome Operations.....                          | 11        |
| § 139.115 Maintenance Service Provider Acceptance.....                               | 11        |
| § 139.117 Aerodrome Consultant Entity. ....  | 12        |
| § 139.119 Inspection Authority .....   | 12        |
| § 139.121 Exemptions .....   | 12        |
| § 139.123 Classification of Findings .....   | 12        |
| <b>SUBPART B – CERTIFICATION OF AERODROMES.....</b>                                  | <b>14</b> |
| § 139.125 Aerodrome Certification requirement.....                                   | 14        |
| § 139.127 Application for Certification.....   | 14        |
| § 139.129 Issuance of Aerodrome Certificate .....                                    | 15        |
| § 139.131 Validity of the Certificate .....  | 15        |
| § 139.133 Renewal and Amendment to the Certificate .....                             | 15        |
| § 139.135 Certificate Holder Responsibilities .....                                  | 16        |
| § 139.137 Aerodrome Manual .....   | 17        |
| § 139.139 Safety Management Systems .....  | 17        |
| § 139.141 Competence of Personnel.....   | 17        |
| <b>SUBPART C – AUTHORIZATION OF AERODROMES .....</b>                                 | <b>19</b> |
| §139.145 Authorization of Aerodromes .....   | 19        |
| §139.147 Application for Aerodrome Authorization.....                                | 19        |

## GACAR PART 139 – CERTIFICATION, AUTHORIZATION AND OPERATION OF AERODROMES

|  |           |
|--|-----------|
| §139.149 Issuance of Authorization .....   | 20        |
| §139.151 Validity of the Authorization .....   | 20        |
| § 139.153 Amendment to the Authorization.....  | 20        |
| § 139.155 Responsibilities of the Authorization Holder.....                                      | 21        |
| <b>SUBPART D – DESIGN &amp; ESTABLISHMENT OF AN AERODROME .....</b>                              | <b>22</b> |
| §139.161 Aerodrome Design and Location .....   | 22        |
| § 139.163 Aerodrome Reference Code.....  | 22        |
| §139.165 Permission for Design and Establishment of Aerodromes.....                              | 23        |
| §139.167 Application for Establishing an Aerodrome .....   | 24        |
| §139.169 Grant of Permission .....   | 24        |
| §139.171 Construction of Aerodrome .....   | 25        |
| <b>SUBPART E – AERODROME DATA .....</b>  | <b>26</b> |
| § 139.201 Common reference systems .....   | 26        |
| § 139.203 Aeronautical Data. ....  | 26        |
| § 139.205 Aerodrome Reference Point (ARP). ....  | 27        |
| § 139.207 Aerodrome and Runway Elevations.....   | 27        |
| § 139.209 Aerodrome Reference Temperature.....   | 27        |
| § 139.211 Aerodrome Dimensions and Related Information. ....                                     | 28        |
| § 139.213 Strength of Pavements. (Applicable until 27 November 2024.) .....                      | 29        |
| § 139.213 Strength of Pavements. (Applicable as of 28 November 2024.).....                       | 31        |
| § 139.215 Pre-Flight Altimeter Check Location.....   | 34        |
| § 139.217 Declared Distances.....  | 34        |
| § 139.219 Condition of the Movement Area and Related Facilities.....                             | 35        |
| § 139.221 Disabled aircraft removal.....   | 39        |
| § 139.223 Rescue and Fire Fighting. ....   | 39        |
| § 139.225 Visual Approach Slope Indicator Systems.....   | 39        |
| § 139.227 Coordination between Aeronautical Information Services and Aerodrome Authorities. .... | 40        |
| § 139.229 Aeronautical charts. ....  | 41        |
| <b>SUBPART F – PHYSICAL CHARACTERISTICS.....</b>   | <b>42</b> |
| § 139.301 Runways.....   | 42        |

## GACAR PART 139 – CERTIFICATION, AUTHORIZATION AND OPERATION OF AERODROMES

|   |           |
|---|-----------|
| § 139.303 Runway shoulders .....  | 50        |
| § 139.305 Runway turn pads .....  | 51        |
| § 139.307 Runway strips.....  | 54        |
| § 139.309 Runway end safety areas.....  | 58        |
| § 139.311 Clearways.....  | 60        |
| § 139.313 Stopways .....  | 62        |
| § 139.315 Radio altimeter operating area .....  | 62        |
| § 139.317 Taxiways .....  | 63        |
| § 139.319 Taxiway shoulders .....   | 69        |
| § 139.321 Taxiway strips.....   | 70        |
| § 139.323 Holding bays, runway-holding positions, intermediate holding positions and road-holding positions ..... | 71        |
| § 139.325 Aprons.....   | 73        |
| § 139.327 Isolated aircraft parking positions.....  | 75        |
| § 139.329 De-icing / Anti- icing facilities .....   | 75        |
| <b>SUBPART G – OBSTACLE RESTRICTION AND REMOVAL .....</b>   | <b>78</b> |
| § 139.401 Obstacle Limitation Surfaces .....  | 78        |
| § 139.403 Obstacle limitation requirements .....  | 87        |
| § 139.405 Objects outside the obstacle limitation surfaces .....  | 94        |
| § 139.407 Other objects .....   | 94        |
| § 139.409 Overlapping of OLS surfaces.....  | 94        |
| § 139.411 Restriction and removal of obstacles .....  | 94        |
| § 139.413 Procedures for aerodrome operators to deal with obstacles in the OLS .....                              | 95        |
| § 139.415 Objects or structures that could become obstacles in the OLS .....                                      | 96        |
| § 139.417 Notes of construction or alteration.....  | 97        |
| § 139.419 Monitoring of obstacles associated with instrument runways .....  | 97        |
| § 139.421 Training.....   | 97        |
| § 139.423 Aerodrome obstacle and terrain charts.....  | 97        |
| § 139.425 Obstacle Survey .....   | 98        |
| <b>SUBPART H – VISUAL AIDS FOR NAVIGATION .....</b>   | <b>99</b> |
| § 139.501 Indicators and signalling devices .....   | 99        |

---

**GACAR PART 139 – CERTIFICATION, AUTHORIZATION AND OPERATION OF  
AERODROMES**

|  |            |
|--|------------|
| § 139.503 Markings .....   | 101        |
| § 139.505 Lights .....   | 126        |
| § 139.507 Signs.....   | 177        |
| § 139.509 Markers .....  | 188        |
| <b>SUBPART I – VISUAL AIDS FOR DENOTING OBSTACLES .....</b>                              | <b>189</b> |
| § 139.601 Objects to be marked and/or lighted .....                                      | 189        |
| § 139.603 Marking and/or lighting of objects.....  | 191        |
| <b>SUBPART J – VISUAL AIDS FOR DENOTING RESTRICTED USE AREAS.....</b>                    | <b>209</b> |
| § 139.701 Closed runways and taxiways, or parts thereof.....                             | 209        |
| § 139.703 Non-load-bearing surfaces .....  | 210        |
| § 139.705 Pre-threshold area .....   | 211        |
| § 139.707 Unserviceable areas.....   | 212        |
| <b>SUBPART K – ELECTRICAL SYSTEMS.....</b>   | <b>213</b> |
| § 139.801 Electrical power supply systems for air navigation facilities.....             | 213        |
| § 139.803 System design .....  | 217        |
| § 139.805 Monitoring .....   | 218        |
| <b>SUBPART L – AERODROME OPERATIONAL SERVICES, EQUIPMENT AND<br/>INSTALLATIONS .....</b> | <b>219</b> |
| § 139.901 Aerodrome emergency planning.....  | 219        |
| § 139.903 Rescue and fire fighting .....   | 222        |
| § 139.905 Disabled aircraft removal.....   | 229        |
| § 139.907 Wildlife strike hazard reduction.....  | 229        |
| § 139.909 Apron management service.....  | 231        |
| § 139.911 Ground servicing of aircraft.....  | 232        |
| § 139.913 Aerodrome vehicle operations .....   | 232        |
| § 139.915 Surface movement guidance and control systems .....                            | 233        |
| § 139.917 Siting of equipment and installations on operational areas.....                | 234        |
| § 139.919 Fencing.....   | 235        |
| § 139.921 Security lighting.....   | 236        |
| § 139.923 Autonomous runway incursion warning system (ARIWS).....                        | 236        |

## GACAR PART 139 – CERTIFICATION, AUTHORIZATION AND OPERATION OF AERODROMES

|  |            |
|--|------------|
| <b>SUBPART M- AERODROME MAINTENANCE .....</b>  | <b>238</b> |
| § 139.1001 General.....  | 238        |
| § 139.1003 Pavements .....   | 238        |
| § 139.1005 Removal of contaminants.....  | 240        |
| § 139.1007 Runway pavement overlays .....  | 241        |
| § 139.1009 Visual aids.....  | 242        |
| <b>APPENDIX A – CERTIFICATION AND AUTHORIZATION.....</b>   | <b>245</b> |
| <b>APPENDIX B – CERTIFICATION OF AERODROMES.....</b>   | <b>247</b> |
| APPENDIX- B-1 AERODROME MANUAL CONTENT .....   | 247        |
| APPENDIX -B-2. PARTICULARS TO BE INCLUDED IN STANDARD OPERATING PROCEDURES.....  | 255        |
| <b>APPENDIX C – AUTHORIZATION OF AERODROMES .....</b>  | <b>256</b> |
| <b>APPENDIX D – DESIGN AND ESTABLISHMENT OF AERODROME.....</b>   | <b>257</b> |
| <b>APPENDIX E – AERODROME DATA .....</b>   | <b>258</b> |
| APPENDIX E-1. Standard method for reporting the bearing strength of the pavement in terms of the Pavement Classification (PCN). (applicable until 27 November 2024). ..... | 258        |
| APPENDIX E-2.....  | 262        |
| APPENDIX E-3. Runway condition report for reporting runway surface condition.....  | 263        |
| APPENDIX E-4.....  | 272        |
| APPENDIX E-5. Drainage characteristics of the movement area and adjacent areas .....   | 273        |
| APPENDIX E-6. Aerodrome mapping data .....   | 277        |
| <b>APPENDIX F - PHYSICAL CHARACTERISTICS.....</b>  | <b>279</b> |
| APPENDIX F-1. Number, siting and orientation of runways.....   | 279        |
| APPENDIX F-2. Grading of a strip for precision approach runways.....   | 281        |
| APPENDIX F-3. Strength of runway strip .....   | 282        |
| APPENDIX F-4. Runway end safety areas (RESA).....  | 283        |
| APPENDIX F-5. Strength of Runway end safety areas (RESA).....  | 284        |
| <b>APPENDIX G - OBSTACLE RESTRICTION AND REMOVAL .....</b>   | <b>285</b> |
| <b>APPENDIX H - VISUAL AIDS FOR NAVIGATION.....</b>  | <b>286</b> |
| <b>APPENDIX I - LOCATION OF LIGHTS ON OBSTACLES .....</b>  | <b>345</b> |
| <b>APPENDIX J - VISUAL AIDS DENOTING RESTRICTED USE AREA.....</b>  | <b>353</b> |

**GACAR PART 139 – CERTIFICATION, AUTHORIZATION AND OPERATION OF  
AERODROMES**

---

|  |            |
|--|------------|
| <b>APPENDIX K – ELECTRICAL SYSTEM.....</b>   | <b>354</b> |
| <b>APPENDIX L – AERODROME OPERATIONAL SERVICES, EQUIPMENT, AND<br/>INSTALLATIONS .....</b> | <b>355</b> |
| APPENDIX L-1. AIRCRAFT RESCUE AND FIREFIGHTING ADDITIONAL REQUIREMENT .....                | 355        |
| APPENDIX L-2. ARFF Qualifications .....  | 360        |
| Appendix L-3. Courses.....   | 364        |
| <b>APPENDIX M – AERODROME MAINTENANCE.....</b>   | <b>368</b> |
| <b>REFERENCES AND GUIDANCE MATERIAL .....</b>  | <b>369</b> |
| <b>ICAO DOCUMENTS RELATED TO THIS GACAR.....</b>   | <b>369</b> |

---

## **GACAR PART 139 – CERTIFICATION, AUTHORIZATION AND OPERATION OF AERODROMES**

---

### **SUBPART A – CERTIFICATION AND AUTHORIZATION**

#### **§ 139.101 General**

- (a) This part is promulgated in accordance with the article 33 of the Civil Aviation Law of the Kingdom of Saudi Arabia, which states that no civil aerodromes or airfields may be constructed, used, or invested in, in the Kingdom of Saudi Arabia (KSA) without obtaining approval of the president.
- (b) The aerodrome design specifications, operations and management requirements for certification or authorization of aerodromes as prescribed in this part.

#### **§ 139.103 Applicability**

- (a) The requirements of this part are applicable to each person employed or used by an aerodrome operator conducting operations and are certified or authorized under this part.
- (b) This part prescribes the technical, operational and management requirements for the certification or authorization of civil aerodromes; be it international or domestic or for use of general aviation in the Kingdom of Saudi Arabia (KSA).
- (c) This part is applicable to all civil /public / private aerodrome operators in the Kingdom of Saudi Arabia.
- (d) All heliports, inside the aerodromes and are operational as a part of the civil/ public aerodromes, must be certificated or authorised under GACAR Part-138.

#### **§ 139.105 Aerodrome Classification and Certification/Authorization Requirements**

- (a) For this part, aerodromes are classified as follows:
  - (1) **Civil/ Public Aerodromes:**  
An aerodrome which is open to the public and serves aircraft operations offering scheduled or nonscheduled commercial air services. All civil /public aerodromes in KSA must be certificated under the provisions of this part.
  - (2) **General Aviation Aerodromes:**  
A General Aviation Aerodrome is an aerodrome, must be authorized under this part, which is used to serve aircraft operations for any purpose other than those listed in §

---

## **GACAR PART 139 – CERTIFICATION, AUTHORIZATION AND OPERATION OF AERODROMES**

---

139.105 (a) (1) The General Aviation aerodromes include but not limited to the following:

(i) Private Aerodrome:

An aerodrome used for the operation of aircrafts for use by its owner or operator and not open to the public. the existence of an obstacle free zone when provided

(ii) Flight Training Aerodrome:

An aerodrome used by flight training schools for providing pilot training and used by the flight instructors, pilots, flight crews and trainees only.

(iii) General Purpose Aerodrome:

An aerodrome used for recreation, aerial work, or air shows to conduct the specified business of an organization other than those as mentioned in § 139.105 (a) (1).

(b) All aerodrome operators must establish necessary facilities and install necessary equipment, appoint qualified & competent personnel for managerial and operational functions and develop documented procedures and manuals as per the requirements given in this part.

(c) Civil /Public aerodrome operators applying for certification must nominate a suitable person to act as the Aerodrome Accountable Executive in accordance with GACAR Part-5 (§ 5.25(a) and (b)) in addition to nominating suitable personnel, who must be accepted by the President, for the following functional positions:

(1) Persons reporting directly to the Aerodrome Accountable Executive

i. Person In-Charge of the Aerodrome

ii. Person In-Charge of Safety in accordance with GACAR Part 5 (§ 5.25(c))

(2) Persons reporting directly to Person in-Charge of the Aerodrome:

i. Person In-Charge of Operations.

ii. Person In-Charge of Maintenance

iii. Person In-Charge of Rescue and Firefighting Services (RFFS).

(d) The aerodrome operators requiring certification must submit customized documents and procedure manuals relevant to the operation. The operators applying for certification are required to submit the following documents and procedure manuals.

(1) Aerodrome Manual;

(2) Safety Management System Manual;



---

## **GACAR PART 139 – CERTIFICATION, AUTHORIZATION AND OPERATION OF AERODROMES**

---

- (3) Security Manual; and
- (4) Aerodrome Emergency Plan Manual
- (e) The aerodrome operators applying for authorization only under Subpart-C, are required to nominate a suitable person to function as the Person In-Charge of the Aerodrome.
- (f) The applicant seeking the authorization under Subpart-C, may submit separate procedures or a customized procedures manual for aerodrome operation procedures, emergency procedures, safety management and security procedures.

### **§ 139.107 Person in Charge of the Aerodrome**

- (a) The Person in Charge of the Aerodrome assumes the responsibility for the overall compliance of the certificated aerodrome with regulatory requirements of this part, assumes the direct supervision of the Person In-charge of Operations, Person In-charge of Maintenance, and Person In-Charge of Rescue and Firefighting Services (RFFS) in the certificated aerodrome, and reports to the Aerodrome Accountable Executive.
- (b) Depending on the size and complexity of the aerodrome and the suitability of the nominated person, the President may accept the Accountable Executive to hold the position of the Person in-charge of the aerodrome.
- (c) Depending on the size and complexity of the aerodrome and the suitability of the nominated person, the President may accept one person to hold the position of the Person In-Charge of the Aerodrome while holding any of the other positions in § 139.105.

### **§ 139.109 Aerodrome Management Personnel**

- (a) Each aerodrome certificate or authorization holder must nominate adequately qualified management personnel or group of persons as specified in § 139.105 (c) and (e) whose responsibilities are to ensure that the organization complies with the requirements of the aerodrome operations, maintenance, and safety functions.
- (b) The certificate or authorization holder must appoint at least the minimum number of management personnel as specified in § 139.105 (c) and (e).
- (c) The Person in-charge of aerodrome operations is responsible for ensuring that the aerodrome operations are performed in accordance with the approved/accepted manuals and procedures and are in compliance with the requirements of this part.

---

## **GACAR PART 139 – CERTIFICATION, AUTHORIZATION AND OPERATION OF AERODROMES**

---

- (d) The Person in-charge of aerodrome maintenance is responsible for ensuring that the aerodrome's maintenance program is carried out in compliance with this part.
- (e) The Person in-charge of aerodrome safety must satisfy the requirements of GACAR Part-5 (§ 5.25(c)) and reports to the Aerodrome Accountable Executive.
- (f) The Person in-charge of aerodrome rescue and firefighting services is responsible to establish and effectively manage all activities related to the rescue and firefighting services.
- (g) Except for the Aerodrome Accountable Executive and the Person In-charge of Safety, who must be appointed in accordance with GACAR Part-5, the management personnel specified in § 139.105 (c) and (e) must be appropriately qualified, experienced, and trained as acceptable to the President and all such details are to be described in the aerodrome manual.
- (h) The aerodrome management personnel must have relevant knowledge and skills to perform the duties and responsibilities, including adequate knowledge in the following subjects:
  - (1) Civil Aviation Law and relevant GACARs.
  - (2) Aerodrome Manual and Operations Procedures; and
  - (3) Theory and practical knowledge related to their functions and responsibilities.
- (i) The President may authorize any management person in the organization, including the accountable executive to oversee additional management functions, depending upon the size, complexity of operations and suitability of the person.
- (j) The names and titles of the management personnel including additional responsibilities along with organizational chart must be listed in the aerodrome manual.
- (k) The aerodrome operator must identify an alternate person for each position to deputize; so that the management functions are smoothly discharged during a leave exceeding thirty days or during the absence of a management personnel. The names of deputizing personnel in each function are to be listed in the aerodrome manual.
- (l) All aerodrome operators, must have minimum number of personnel required for operation, safety, maintenance, and rescue and firefighting which must be determined based on a task resource analysis.

### **§ 139.111 Prohibition of the Problematic Use of Psychoactive Substances.**

- (a) The requirements prescribed in GACAR Part-7 are applicable to all aerodrome operators certified or authorized under this part.
- (b) No person be present on the movement area of an aerodrome which is certificated/authorized under this part while under the influence of any psychoactive substance, by reason of which human performance is impaired.

---

## **GACAR PART 139 – CERTIFICATION, AUTHORIZATION AND OPERATION OF AERODROMES**

---

- (c) No aerodrome certificate /authorization holder allows a person, who appears to be or who conducts in such a manner or physical indications that the individual is under the influence of psychoactive substances (except a patient under medical care), be present on the movement area of the aerodrome.
- (d) Whenever the President has a reasonable basis to believe that a person is under the influence of psychoactive substances, the President may seek the person to undergo necessary examination or tests at the authorized medical center or lab to confirm whether the person is under the influence of any psychoactive substance.

### **§ 139.113 Specific procedures for Aerodrome Operations**

- (a) The certificated or authorized aerodromes must allow operations of aircraft, for which the design, physical and operational characteristics of aerodrome, is suitable.
- (b) When operational parameters of an aircraft exceed the physical and operational characteristics of the aerodrome as mentioned in paragraph (a) above, the aerodrome operator must carry out an aerodrome compatibility study and take suitable actions to confirm the acceptable level of safety in operation, prior to permitting such operations.
- (c) Information concerning alternative measures, changes to operational procedures and operating restrictions, if implemented at an aerodrome and granted regulatory exemption to aerodrome operations, must be published in the Kingdom of Saudi Arabia Aeronautical Information Publication (AIP).

### **§ 139.115 Maintenance Service Provider Acceptance.**

- (a) Maintenance Service Provider.
  - (1) No aerodrome certificate holder may outsource any aerodrome maintenance functions unless otherwise accepted by the President.
  - (2) The aerodrome operator must, if maintenance services are subcontracted, recommend the maintenance service provider for acceptance of the President.
  - (3) To obtain an acceptance, to utilize the services of an aerodrome maintenance services provider, an aerodrome certificate holder must submit a request in a form and manner prescribed by the President.
  - (4) An aerodrome maintenance services provider will be evaluated by General Authority of Civil Aviation (GACA) based on its ability to demonstrate proven related experience, adequacy of competent personnel, an effective quality management system, equipment/tools, and any other requirements related to the aerodrome maintenance services provider's areas of involvement.

---

## GACAR PART 139 – CERTIFICATION, AUTHORIZATION AND OPERATION OF AERODROMES

---

### § 139.117 Aerodrome Consultant Entity.

- (a) Aerodrome consultant is a legal entity that has the expertise in discharging the functions of designing, constructing and /or carrying out the supervisory functions.
- (b) The aerodrome certificate holder / operator is fully responsible to choose the appropriate consultant based on its ability to demonstrate proven related experience, adequacy of competent personnel, an effective quality management system, and any other requirements related to the consultant's areas of involvement.

### § 139.119 Inspection Authority

- (a) The President or his/her authorized representative has the authority to conduct planned inspections, unannounced spot inspection, audits and onsite verification of facility, documents, and records to determine the compliance with the regulatory requirements.
- (b) The aerodrome operator must allow the President or his/her representative to have unrestricted access to all the areas of the aerodrome.
- (c) When the President determines that a violation has occurred, the suitable legal enforcement action may be taken against the certified/authorised aerodrome as per the provisions of GACAR Part-13. The president may decide the circumstances or conditions under which the aerodrome certification or authorisation holder deals with violation which is observed during the internal process of audits and inspections.

### § 139.121 Exemptions

- (a) In case of any deviation from any aerodrome specification requirements that is permitted under the regulations in this part, an applicant must conduct an aeronautical study/safety risk assessment with the mitigation measures, if any for safe operation, as acceptable to the President.
- (b) Exemptions from the regulatory requirements or standards of this part must be processed as per the regulations stipulated in GACAR Part-11 along with an aeronautical study/safety risk assessment to be conducted by the aerodrome operator to provide an equivalent level of safety for safe operation.
- (c) A list of all granted regulatory exemptions must be included in the aerodrome manual as stipulated in Appendix B-1 to this part.

### § 139.123 Classification of Findings

- (a) A level-1 finding is any significant non-compliance with the GACAR Part-139 requirements which lowers the safety standard and capable of causing serious risk to the flight safety.

## **GACAR PART 139 – CERTIFICATION, AUTHORIZATION AND OPERATION OF AERODROMES**

---

- (b) A level-2 finding is any non-compliance with the GACAR Part-139 requirements which could lower the safety standard and possibly cause hazard to the flight safety.
- (c) A level-3 finding is an observation or recommendation to improve safety standards and/or achieve a better practice by addressing deficiencies that may lead to potential findings of level-2 if not corrected.
- (d) On receipt of notification of findings, aerodrome certificate holder must develop a corrective action plan and demonstrate corrective action is taken to the satisfaction of the President within a period agreed.

## **GACAR PART 139 – CERTIFICATION, AUTHORIZATION AND OPERATION OF AERODROMES**

---

### **SUBPART B – CERTIFICATION OF AERODROMES**

#### **§ 139.125 Aerodrome Certification requirement**

- (a) The requirements for issuance of aerodrome certificate is applicable to the aerodromes open to the public and serves aircraft operations offering scheduled or non-scheduled commercial air services/operation.
- (b) No aerodrome operators are permitted to operate public aerodrome unless certificated as per the provisions of this part.

#### **§ 139.127 Application for Certification**

- (a) The application for certification of aerodrome must be submitted in a form and manner acceptable to the President.
- (b) The applicant must ensure that the aerodrome physical characteristics, facilities, services, and equipment installed and meet the requirements of this part.
- (c) The application for the aerodrome certification must be submitted in a prescribed form as mentioned in paragraph (a) above along with the following documents, manuals, approvals, agreements, and reports:
  - (1) Statement of regulations compliance in prescribed form with completed compliance checklist;
  - (2) List of management personnel along with Curriculum Vitae and relevant testimonials;
  - (3) Aerodrome manual;
  - (4) Safety management system (SMS) manual;
  - (5) Aerodrome emergency plan manual;
  - (6) Aerodrome obstacle survey reports;
  - (7) Aeronautical study report and/or safety risk assessment, if applicable;
  - (8) Approval for operation of aerodrome from municipality;

---

## **GACAR PART 139 – CERTIFICATION, AUTHORIZATION AND OPERATION OF AERODROMES**

---

- (9) Agreement for providing Air Navigation Services for aerodrome;
- (10) Aerodrome land ownership proof or lease agreement;
- (11) Environmental Permit from National Center for Environmental Compliance; and
- (12) Any other relevant documents as required by the President.

### **§ 139.129 Issuance of Aerodrome Certificate**

- (a) An applicant may be issued with an aerodrome certificate upon confirming that the applicant meets the provisions of this part and no findings or deviations are reported or once the corrective action plans are accepted and mitigation measures are agreed upon.

### **§ 139.131 Validity of the Certificate**

- (a) The aerodrome certificate is issued for a maximum period of five years and thereafter renewed for five years. It remains valid subject to the conditions that:
  - (1) The organization is maintaining the compliance with requirements this part;
  - (2) The certificate is not being surrendered or revoked; and
  - (3) The President suspends or cancels the certificate.
- (b) Upon surrender or revocation, the certificate must be returned to GACA.

### **§ 139.133 Renewal and Amendment to the Certificate**

- (a) The aerodrome certificate holder must apply to the President for renewal or reissuance of the certificate at least three months prior to the expiry of validity of the certificate or commencement of operations whichever is earlier. The application must be submitted along with the updated documents and duly completed checklists as per requirements given in §139.127.
- (b) The certificate holder must have procedures in aerodrome manual to notify the President of any changes in the organization's activities, locations or personnel.
- (c) No aerodrome certificate holder must implement any major changes as mentioned in (b) above without prior acceptance of the President. Major changes are those changes that have direct or indirect influence on the safety of the operation including:
  - (1) The physical characteristics of the aerodrome;

---

## **GACAR PART 139 – CERTIFICATION, AUTHORIZATION AND OPERATION OF AERODROMES**

---

- (2) The location of the principal base of operations of the certificate holder;
  - (3) The change of management personnel; or
  - (4) The change in aerodrome manual, operating procedures, facilities, systems, or any work that may affect the safety of the aerodrome operations.
- (d) The certificate holder must apply in a form and manner acceptable to the president for acceptance of any major changes that affect the scope of certification and which require revisions to the aerodrome manual.

### **§ 139.135 Certificate Holder Responsibilities**

- (a) The aerodrome certificate holder is responsible:
- (1) To maintain the aerodrome in accordance with requirements specified in the accepted aerodrome manual and requirement of this part;
  - (2) To update and distribute the aerodrome manual among all stakeholders;
  - (3) To appoint suitably qualified, trained, and experienced management personnel as required in §139.107 and §139.109 of this part;
  - (4) To prepare, implement and monitor the service level agreements, in case any of the aerodrome services are outsourced;
  - (5) To inform the President whenever services or facilities fall below the requirements prescribed in the aerodrome manual;
  - (6) To be responsible for the aerodrome infrastructure development, change management and any other tasks that are carried out by the contractor at the recommendation of the design consultants and/or by the supervisory consultants as per the set standards;
  - (7) To take the overall responsibility of aerodrome maintenance that is to be performed as per the approved standards;
  - (8) To report safety occurrences including any incidents, serious incidents, and accidents to the President in accordance with the requirements stipulated in GACAR Part 4; and
  - (9) To implement SMS in accordance with the requirement of GACAR Part 5.
- (b) Any other responsibility assigned by the President.



## **GACAR PART 139 – CERTIFICATION, AUTHORIZATION AND OPERATION OF AERODROMES**

---

### **§ 139.137 Aerodrome Manual**

- (a) Aerodrome operators who intend to apply for certification, must develop and submit an aerodrome manual for acceptance by the President.
- (b) Each aerodrome certificate holder must develop the aerodrome manual as per contents prescribed in Appendix B-1 of this part.
- (c) A signed copy of aerodrome manual must be submitted to the GACA in a print form.
- (d) Exemption granted from meeting the regulatory requirements must be published in the AIP.
- (e) Maintain at least one copy of updated aerodrome manual at the aerodrome and one copy at the operator's principal place of business if the place of business is other than the aerodrome.
- (f) Ensure that the appropriate portions of the aerodrome manual are readily accessible to aerodrome operating personnel for reference to discharge day-to-day activities.
- (g) Any proposed amendment to the aerodrome manual must be submitted to the President at least 30 working days before the proposed effective date unless a shorter filing period is accepted by the president. The relevant portion only of the amendments, to be made in the aerodrome manual, needs to be submitted.
- (h) The revised pages must be appended with the aerodrome manual once the amendments are accepted by the President.

### **§ 139.139 Safety Management Systems**

- (a) The certificate holder must develop and implement Safety Management System (SMS) manual as per the provisions of GACAR Part- 5.
- (b) The SMS Manual, for the purpose of implementing the aerodrome SMS requirements as mentioned in 139.135 – (a) – (9), must be developed in accordance with contents stipulated in the GACAR Part- 5 and submitted to the President for acceptance.

### **§ 139.141 Competence of Personnel**

- (a) The aerodrome operator must describe the following competency requirements in the aerodrome manual and ensure that the persons possess competency with regard to:
  - (1) Relevant knowledge, skills, and experience in the respective field of aerodrome operation, maintenance, safety and rescue & firefighting;
  - (2) Appropriate attitude towards safety and observance of procedures; and
  - (3) Knowledge of the associated procedures of the certificate holders.

## **GACAR PART 139 – CERTIFICATION, AUTHORIZATION AND OPERATION OF AERODROMES**

---

- (b) In accordance with the job functions, adequate initial and recurrent training must be provided to persons to ensure that continued competence is maintained throughout the duration of employment / contract and validity of certificate.
- (c) The training program must be developed so as ensure that each employee, assigned to perform the functions including operation, safety, rescue and firefighting, and maintenance, is capable to perform the assigned task effectively and efficiently.
- (d) The certificate holder must maintain the training records of all the personnel who have been imparted the training.
- (e) Each person in the organization must be assessed in accordance with the procedure as established by the aerodrome operator to ensure that personnel's competency is satisfactory for functions to be performed.
- (f) Each technical person such as from operations, rescue and firefighting, maintenance and safety disciplines must undergo refresher training at least once in two years.
- (g) The training program must be developed considering the requirements of relevant GACARs.

## **GACAR PART 139 – CERTIFICATION, AUTHORIZATION AND OPERATION OF AERODROMES**

---

### **SUBPART C – AUTHORIZATION OF AERODROMES**

#### **§139.145 Authorization of Aerodromes**

- (a) The issuance of aerodrome authorization is applicable to aerodromes as per the classification of aerodromes stipulated in §139.105.
- (b) No aerodrome operator is permitted to operate an aerodrome or provide services without obtaining prior authorization from the President for the type of operation.

#### **§139.147 Application for Aerodrome Authorization**

- (a) The application for authorization of aerodrome must be submitted in a form and manner acceptable to the President.
- (b) The applicant must ensure that the aerodrome physical characteristics, facilities, aerodrome support services and equipment installed and meet the requirements of this part.
- (c) The application for the aerodrome authorization must be submitted in a prescribed form along with the following documents, approvals, agreements, and reports:
  - (1) Statement of regulatory compliance along with completed compliance checklist;
  - (2) List of management personnel and their Curriculum Vitae with relevant testimonials;
  - (3) A customized procedures manual for aerodrome which includes, operation procedures, emergency procedures, safety management and security procedures;
  - (4) Aerodrome obstacle survey reports;
  - (5) Aeronautical study report and/or safety risk assessment, if applicable;
  - (6) Approvals for operations of aerodrome from Municipality;
  - (7) No objection certificate / letter for operations of aerodrome from SANS;
  - (8) Aerodrome land ownership proof or lease agreement;
  - (9) Environmental Permit from National Center for Environmental Compliance; and

---

## **GACAR PART 139 – CERTIFICATION, AUTHORIZATION AND OPERATION OF AERODROMES**

---

- (10) Any other relevant documents as required by the President.

### **§139.149 Issuance of Authorization**

- (a) An applicant may be issued an aerodrome authorization upon confirming that the applicant meets the requirements of this part and no findings or deviations are reported or once the corrective action plans are accepted and mitigation measures are agreed upon.

### **§139.151 Validity of the Authorization**

- (a) The aerodrome authorization issued will remain valid, subject to:
- (1) The organization is maintaining the compliance with this part;
  - (2) Provide access of aerodrome to GACA officers to determine continued compliance with the requirements of this part;
  - (3) The authorization is not being surrendered or revoked; and
  - (4) The President suspends or cancels the authorization.
- (b) Upon surrender or revocation, the authorization must be returned to the President.

### **§ 139.153 Amendment to the Authorization**

- (a) The authorization holder must make the provisions for making an amendment in aerodrome operation procedures manual and to notify the President of any changes in the organization's activities or locations or personnel.
- (b) No aerodrome authorization holder must implement any major changes as mentioned in paragraph (a) above without obtaining prior approval from the President. Major changes are those changes that affects the standards stipulated in this part or have direct or indirect influence on the safety of the operation including:
- (1) The physical characteristics of the aerodrome;
  - (2) The location of the principal base of operations of the authorization holder;
  - (3) Change of management personnel; or

## **GACAR PART 139 – CERTIFICATION, AUTHORIZATION AND OPERATION OF AERODROMES**

---

- (4) The change in the aerodrome operation manual, operating procedures, facilities, systems, any work that may affect the safety of the aerodrome operations.

### **§ 139.155 Responsibilities of the Authorization Holder**

An authorization holder of an aerodrome must:

- (1) Have a single point of responsibility for the authorized aerodrome for its management of safe operation, maintenance, and security as per the provisions of this part.
- (2) Conduct aerodrome operations which meet the safety management system requirements in accordance with GACAR Part- 5 as appropriate to the size and complexity of the operation.
- (3) Report safety occurrences to the President in accordance with requirements stipulated in GACAR Part 4.
- (4) Provide initial training to all technical personnel prior to assigning them on tasks independently, and conduct refresher training at least once in two years to ensure that competence is maintained throughout the duration of their employment or contract.

## **GACAR PART 139 – CERTIFICATION, AUTHORIZATION AND OPERATION OF AERODROMES**

---

### **SUBPART D – DESIGN & ESTABLISHMENT OF AN AERODROME**

#### **§139.161 Aerodrome Design and Location**

- (a) A master plan containing detailed plans for the development of aerodrome infrastructure must be established by the aerodrome operator.
- (b) The master plan must:
  - (1) contain a schedule of priorities including a phased implementation plan; and
  - (2) be reviewed periodically to take into account current and future aerodrome traffic.
- (c) Aerodrome operator must consult other stakeholders, particularly aircraft operators, in order to facilitate the master planning process using a consultative and collaborative approach.
- (d) Architectural and infrastructure-related requirements for the optimum implementation of security measures must be integrated into the design and construction of new facilities and alterations to existing facilities at an aerodrome.
- (e) The aerodrome operator must give due consideration for design of aerodromes considering the land-use and environmental impact control measures.
- (f) The aerodrome usability factor and the orientation for approach and take-off direction must be considered during the project feasibility and at design stage; so that aerodrome is available for maximum time for operations. The usability factor must be at least 95 percent for public aerodrome for their intended operations.

#### **§ 139.163 Aerodrome Reference Code**

- (a) An aerodrome reference code (code number and letter) which is selected for aerodrome planning purposes must be determined in accordance with the characteristics of the aeroplane for which an aerodrome facility is intended.
- (b) The aerodrome reference code numbers and letters must have the meanings assigned to them in Table D-1.
- (c) The code number for element 1 must be determined from Table D-1, selecting the code number corresponding to the highest value of the aeroplane reference field lengths of the aeroplane for which the runway is intended.
- (d) The code letter for element 2 must be determined from Table D-1, by selecting the code letter which corresponds to the greatest wingspan of the aeroplane for which the facility is intended.

## GACAR PART 139 – CERTIFICATION, AUTHORIZATION AND OPERATION OF AERODROMES

| Code element 1 |   |
|----------------|---|
| Code number    | Aeroplane reference field length        |
| 1              | Less than 800 m                         |
| 2              | 800 m up to but not including 1 200 m   |
| 3              | 1 200 m up to but not including 1 800 m |
| 4              | 1 800 m and over                        |
| Code element 2 |   |
| Code letter    | Wingspan                                |
| A              | Up to but not including 15 m            |
| B              | 15 m up to but not including 24 m       |
| C              | 24 m up to but not including 36 m       |
| D              | 36 m up to but not including 52 m       |
| E              | 52 m up to but not including 65 m       |
| F              | 65 m up to but not including 80 m       |

**Table D-1. Aerodrome Reference Code ((see § 139.163 (b) to (d))**

### **§139.165 Permission for Design and Establishment of Aerodromes.**

- (a) Any person or organization intending to establish an aerodrome, must apply in a form and manner acceptable to the President for prior permission.
- (b) The applicant must be the legal owner of the land or hold valid lease agreement or legal rights to use the land for the purpose of establishment of an aerodrome.
- (c) In case of engaging a specialized consultant for design or for discharging the supervisory function, the applicant must obtain prior permission from the President by submitting the details of the consultant in prescribed form.
- (d) Notwithstanding the permission granted to establish aerodromes or engaging aerodrome design consultants, the aerodrome operator must obtain certification or authorization prior to commencement of operations.

---

## **GACAR PART 139 – CERTIFICATION, AUTHORIZATION AND OPERATION OF AERODROMES**

---

### **§139.167 Application for Establishing an Aerodrome**

- (a) The applicant must submit the following documents for the grant of permission to establish an aerodrome:
- (1) Application for establishment of aerodrome in the prescribed form;
  - (2) Statement of compliance with regulations in the prescribed form;
  - (3) Proof of ownership or lease rights of the land;
  - (4) Environmental Permit from National Center for Environmental Compliance;
  - (5) Aerodrome feasibility study report (including site selection, weather data, tabulated wind data, wind rose analysis, approach and take-off climb surfaces orientation, obstacle limitation surfaces survey, topographical area map, critical aircraft and mixed fleet details, aerodrome design and master plan with dimensions, visual aids - markings and lightings);
  - (6) Aeronautical study report, if applicable;
  - (7) Approvals for establishment of aerodrome from Municipality;
  - (8) No objection certificate for establishment of aerodrome from SANS; and
  - (9) Details of consultant entity, if appointed.
- (b) Any other relevant document(s) required by the President.

### **§139.169 Grant of Permission**

- (a) An applicant may be granted permission to establish an aerodrome, if the President considers that the applicant meets the requirements of this part;
- (b) The President may stipulate additional requirements or conditions that are necessary to be included to ensure aviation safety; and
- (c) The President may suspend or cancel the establishment permission, if convinced that applicant has violated the provisions of the permission or the GACARs that may affect the safety of operation.



## **GACAR PART 139 – CERTIFICATION, AUTHORIZATION AND OPERATION OF AERODROMES**

---

### **§139.171 Construction of Aerodrome**

- (a) The applicant, once granted the establishment permission, must construct the aerodrome as per provisions of the permission and requirements of the relevant authorities for construction and in compliance with safety regulations.
- (b) The applicant must allow the GACA to inspect the aerodrome during the course of construction and that the construction takes place as per provisions of the establishment permission and meets the requirements of this part.

---

## GACAR PART 139 – CERTIFICATION, AUTHORIZATION AND OPERATION OF AERODROMES

---

### SUBPART E – AERODROME DATA

#### § 139.201 Common reference systems

- (a) Horizontal reference system  
World Geodetic System — 1984 (WGS-84) must be used as the horizontal (geodetic) reference system. Reported aeronautical geographical coordinates indicating latitude and longitude must be expressed in terms of the WGS-84 geodetic reference datum.
- (b) Vertical reference system  
Mean sea level (MSL) datum, which gives the relationship of gravity-related height (elevation) to a surface known as the geoid, must be used as the vertical reference system.
- (c) Temporal reference system  
The Gregorian calendar and Coordinated Universal Time (UTC) must be used as the temporal reference system.

#### § 139.203 Aeronautical Data.

- (a) Determination and reporting of aerodrome-related aeronautical data must be in accordance with the accuracy and integrity classification required to meet the needs of the end-users of aeronautical data.
- (b) Aerodrome mapping data must be made available to the certified aeronautical information services provider for aerodromes deemed relevant by President where safety and/or performance-based operations suggest possible benefits.

*Note 1. - Aerodrome data must be provided as specified in GACAR Part 175 and related guidance materials and ICAO PANS-AIM (Doc 10066).*

*Note 2 - Guidance material concerning the application of Aerodrome mapping databases is provided in Appendix E-6 of this subpart.*

- (c) Where made available in accordance with §139.203 (b), the selection of the aerodrome mapping data features to be collected must be made with consideration of the intended applications.
- (d) Digital data error detection techniques must be used during the transmission and/or storage of aeronautical data and digital data sets.
- (e) Specifications concerning the accuracy, integrity classification related to aerodrome-related aeronautical data, aerodrome mapping databases related provisions and digital data error detection techniques are contained in GACAR Part 175 and ICAO PANS-AIM (Doc 10066), Appendix 1.

## **GACAR PART 139 – CERTIFICATION, AUTHORIZATION AND OPERATION OF AERODROMES**

---

- (f) It is intended that the selection of the features to be collected match a defined operational need.
- (g) Aerodrome mapping databases can be provided at one of two levels of quality — fine or medium. These levels and the corresponding numerical requirements are defined in Radio Technical Commission for aeronautics (RTCA) Document DO-272B and European Organization for Civil Aviation Equipment (EUROCAE) Document ED-99C — User Requirements for Aerodrome Mapping Information.

### **§ 139.205 Aerodrome Reference Point (ARP).**

- (a) An aerodrome reference point must be established for an aerodrome.
- (b) The aerodrome reference point must be located near the initial or planned geometric center of the aerodrome (all usable runways) and must normally remain where first established.
- (c) The position of the aerodrome reference point must be measured and reported to the President in degrees, minutes and seconds.

### **§ 139.207 Aerodrome and Runway Elevations.**

- (a) The aerodrome elevation and geoid undulation at the aerodrome elevation position must be measured to the accuracy of one-half meter or foot and reported to the President.
- (b) For an aerodrome used by international civil aviation for non-precision approaches, the elevation and geoid undulation of each threshold, the elevation of the runway end and any significant high and low intermediate points along the runway must be measured to the accuracy of one-half metre or foot and reported to the President.
- (c) For precision approach runway, the elevation and geoid undulation of the threshold, the elevation of the runway end and the highest elevation of the touchdown zone must be measured to the accuracy of one-quarter metre or foot and reported to the President.

*Note. — Geoid undulation must be measured in accordance with the appropriate system of coordinates.*

### **§ 139.209 Aerodrome Reference Temperature.**

- (a) An aerodrome reference temperature must be determined for an aerodrome in degrees Celsius.
- (b) The aerodrome reference temperature must be the monthly mean of the daily maximum temperatures for the hottest month of the year (the hottest month being that which has the highest monthly mean temperature). This temperature must be averaged over a period of years.

## GACAR PART 139 – CERTIFICATION, AUTHORIZATION AND OPERATION OF AERODROMES

### § 139.211 Aerodrome Dimensions and Related Information.

(a) The following data must be measured or described, as appropriate, for each facility provided on an aerodrome:

- (1) Runway — true bearing to one-hundredth of a degree, designation number, length, width, displaced threshold location to the nearest meter or foot, slope, surface type, type of runway and, for a precision approach runway category I, the existence of an obstacle free zone when provided;
- (2) Strip runway end safety area stopway } Length, width to the nearest metre or foot, surface type; and

Arresting system – location (which runway end) and description;

- (3) Taxiway — designation, width, surface type;
  - (4) Apron — surface type, aircraft stands;
  - (5) The boundaries of the air traffic control service;
  - (6) Clearway — length to the nearest metre or foot, ground profile;
  - (7) Visual aids for approach procedures, marking and lighting of runways, taxiways and aprons, other visual guidance and control aids on taxiways and aprons, including taxi-holding positions and stopbars, and location and type of visual docking guidance systems;
  - (8) Location and radio frequency of any VOR aerodrome checkpoint;
  - (9) Location and designation of standard taxi-routes; and
  - (10) Distances to the nearest metre or foot of localizer and glide path elements comprising an instrument landing system (ILS) or azimuth and elevation antenna of a microwave landing system (MLS) in relation to the associated runway extremities.
- (b) The geographical coordinates of each threshold must be measured and reported to the President in degrees, minutes, seconds, and hundredths of seconds.
- (c) The geographical coordinates of appropriate taxiway center line points must be measured and reported to the President in degrees, minutes, seconds, and hundredths of seconds.
- (d) The geographical coordinates of each aircraft stand must be measured and reported to the President in degrees, minutes, seconds, and hundredths of seconds.
- (e) The geographical coordinates of obstacles in Area 2 (the part within the Aerodrome boundary) and in Area 3 must be measured and reported to the President in degrees, minutes, seconds and tenths of seconds. In addition, the top elevation, type, marking and lighting (if any) of obstacles must be reported to the President.

## GACAR PART 139 – CERTIFICATION, AUTHORIZATION AND OPERATION OF AERODROMES

*Note 1. — See GACAR Part 175 and Annex 15, Appendix 1, for graphical illustrations of obstacle data collection surfaces and criteria used to identify obstacles in Areas 2 and 3.*

*Note 2. — PANS-AIM (Doc 10066), Appendix 1 and Appendix 8 provide requirements for obstacle data determination in Areas 2 and 3.*

### § 139.213 Strength of Pavements. (Applicable until 27 November 2024.)

- (a) The bearing strength of a pavement must be determined.
- (b) The bearing strength of a pavement intended for aircraft of apron (ramp) mass greater than 5,700 kg must be made available using the aircraft classification number — pavement classification number (ACN-PCN) method by reporting all the following information:
  - (1) The pavement classification number (PCN);
  - (2) Pavement type for ACN-PCN determination;
  - (3) Subgrade strength category;
  - (4) Maximum allowable tire pressure category or maximum allowable tire pressure value; and
  - (5) Evaluation method.
- (c) The pavement classification number (PCN) reported must indicate that an aircraft with an aircraft classification number (ACN) equal to or less than the reported PCN can operate on the pavement subject to any limitation on the tire pressure, or aircraft all-up mass for specified aircraft type(s).
- (d) The ACN of an aircraft must be determined in accordance with the standard procedures associated with the ACN-PCN method.
- (e) For the purposes of determining the ACN, the behavior of a pavement must be classified as equivalent to a rigid or flexible construction.
- (f) Information on pavement type for ACN-PCN determination, subgrade strength category, maximum allowable tire pressure category and evaluation method must be reported using the following codes:

- (1) Pavement type for ACN-PCN determination:

|                   | Code |
|-------------------|------|
| Rigid pavement    | R    |
| Flexible pavement | F    |

## GACAR PART 139 – CERTIFICATION, AUTHORIZATION AND OPERATION OF AERODROMES

(2) Sub-grade strength category

|   | Code |
|---|------|
| High strength: characterized by $K = 150 \text{ MN/m}^3$ and representing all $K$ values above $120 \text{ MN/m}^3$ for rigid pavements, and by $\text{CBR} = 15$ and representing all $\text{CBR}$ values above 13 for flexible pavements.       | A    |
| Medium strength: characterized by $K = 80 \text{ MN/m}^3$ and representing a range in $K$ of 60 to $120 \text{ MN/m}^3$ for rigid pavements, and by $\text{CBR} = 10$ and representing a range in $\text{CBR}$ of 8 to 13 for flexible pavements. | B    |
| Low strength: characterized by $K = 40 \text{ MN/m}^3$ and representing a range in $K$ of 25 to $60 \text{ MN/m}^3$ for rigid pavements, and by $\text{CBR} = 6$ and representing a range in $\text{CBR}$ of 4 to 8 for flexible pavements.       | C    |
| Ultra low strength: characterized by $K = 20 \text{ MN/m}^3$ and representing all $K$ values below $25 \text{ MN/m}^3$ for rigid pavements, and by $\text{CBR} = 3$ and representing all $\text{CBR}$ values below 4 for flexible pavements       | D    |

(3) Maximum allowable tire pressure category:

|                                      | Code |
|--------------------------------------|------|
| Unlimited: no pressure limit         | W    |
| High: pressure limited to 1.75 MPa   | X    |
| Medium: pressure limited to 1.25 MPa | Y    |
| Low: pressure limited to 0.50 MPa    | Z    |

(4) Evaluation method:

|   | Code |
|---|------|
| Technical evaluation: representing a specific study of the pavement characteristics and application of pavement behaviour technology.           | T    |
| Using aircraft experience: representing a knowledge of the specific type and mass of aircraft satisfactorily being supported under regular use. | U    |

---

## **GACAR PART 139 – CERTIFICATION, AUTHORIZATION AND OPERATION OF AERODROMES**

---

*Note - Refer Appendix E-1 for guidance on Standard Method for reporting the bearing strength of the pavement in terms of the Pavement Classification Number (PCN). (Applicable until 27 November 2024.)*

(g) Criteria to regulate the use of a pavement by an aircraft with an ACN higher than the PCN reported (overload operations) for that pavement in accordance with §139.213 (b) and §139.213 (c) must be as below:

- (1) For flexible pavements, occasional movements by aircraft with ACN not exceeding 10 per cent above the reported PCN;
- (2) For rigid or composite pavements, in which a rigid pavement layer provides a primary element of the structure, occasional movements by aircraft with ACN not exceeding 5 per cent above the reported PCN;
- (3) If the pavement structure is unknown, the 5 per cent limitation must apply; and
- (4) The annual number of overload movements must not exceed approximately 5 per cent of the total annual aircraft movements.

*Note: Also refer ICAO Annex 14 Volume I, Attachment A.20 and ICAO Doc 9157 Part 3 – Pavements, Chapter 2.*

(h) The bearing strength of a pavement intended for aircraft of apron (ramp) mass equal to or less than 5,700 kg must be made available by reporting the following information:

- (1) Maximum allowable aircraft mass; and
- (2) Maximum allowable tire pressure.

Example: 4,000 kg/0.50 mPa.

### **§ 139.213 Strength of Pavements. (Applicable as of 28 November 2024.)**

- (a) The bearing strength of a pavement must be determined.
- (b) The bearing strength of a pavement intended for aircraft of apron (ramp) mass greater than 5 700 kg must be made available using the aircraft classification rating-pavement classification rating (ACRPCR) method by reporting all of the following information:

## GACAR PART 139 – CERTIFICATION, AUTHORIZATION AND OPERATION OF AERODROMES

- (1) Pavement classification rating (PCR) and numerical value;
- (2) Pavement type for ACR-PCR determination;
- (3) Subgrade strength category;
- (4) Maximum allowable tire pressure category or maximum allowable tire pressure value; and
- (5) Evaluation method.

(c) The PCR reported must indicate that aircraft with an aircraft classification rating (ACR) equal to or less than the reported PCR may operate on the pavement subject to any limitation on the tire pressure or aircraft all-up mass for specified aircraft type(s).

Note. — Different PCRs may be reported if the strength of the pavement is subject to significant seasonal variation.

- (d) The ACR of an aircraft must be determined in accordance with the standard procedures associated with the ACR-PCR method.
- (e) For the purposes of determining the ACR, the behavior of a pavement must be classified as equivalent to a rigid or flexible construction.
- (f) Information on pavement type for ACR-PCR determination, subgrade strength category, maximum allowable tire pressure category and evaluation method must be reported using the following codes:

- (1) Pavement type for ACR-PCR determination:

|                   | Code |
|-------------------|------|
| Rigid pavement    | R    |
| Flexible pavement | F    |

- (2) Sub-grade strength category

|   | Code |
|---|------|
| High strength: characterized by $K = E = 200\text{MPa}$ and representing all E values equal to or above 150 MPa for rigid or flexible pavements.                                      | A    |
| Medium strength: characterized by $E = 120\text{ MPa}$ and representing a range in E values equal to or above 100 MPa and strictly less than 150 MPa for rigid or flexible pavements. | B    |



## GACAR PART 139 – CERTIFICATION, AUTHORIZATION AND OPERATION OF AERODROMES

|  |   |
|--|---|
| Low strength: characterized by by E = 80 MPa and representing a range in E values equal to or above 60 MPa and strictly less than 100 MPa MPa for rigid or flexible pavements. | C |
| Ultra Low strength: characterized by E = 50 MPa and representing all E values strictly less than 60 MPa for rigid or flexible pavements.                                       | D |

(3) Maximum allowable tire pressure category:

|                                      | Code |
|--------------------------------------|------|
| Unlimited: no pressure limit         | W    |
| High: pressure limited to 1.75 MPa   | X    |
| Medium: pressure limited to 1.25 MPa | Y    |
| Low: pressure limited to 0.50 MPa    | Z    |

(4) Evaluation method:

|  | Code |
|--|------|
| Technical evaluation: representing a specific study of the pavement characteristics and types of aircraft which the pavement is intended to serve. | T    |
| Using aircraft experience: representing a knowledge of the specific type and mass of aircraft satisfactorily being supported under regular use.    | U    |

(g) Criteria to regulate the use of a pavement by an aircraft with an ACR higher than the PCR reported for that pavement in accordance with §139.213 (b) and §139.213 (c) must be as below:

- (1) For flexible and rigid pavements, occasional movements by aircraft with ACR not exceeding 10 percent above the reported PCR should not adversely affect the pavement; and
- (2) The annual number of overload movements must not exceed approximately 5 percent of the total annual movements excluding light aircraft.

---

## **GACAR PART 139 – CERTIFICATION, AUTHORIZATION AND OPERATION OF AERODROMES**

---

*Note: Also refer ICAO Annex 14 Volume I, Attachment A.20 and ICAO Doc 9157 Part 3 – Pavements, Chapter 2.*

- (i) The bearing strength of a pavement intended for aircraft of apron (ramp) mass equal to or less than 5,700 kg must be made available by reporting the following information:
  - (1) Maximum allowable aircraft mass; and
  - (2) Maximum allowable tire pressure.

Example: 4,800 kg/0.60 mPa.

### **§ 139.215 Pre-Flight Altimeter Check Location.**

- (a) One or more pre-flight altimeter check locations must be established for an aerodrome.
- (b) A pre-flight check location must be located on an apron. Locating a pre-flight altimeter check location on an apron enables an altimeter check to be made prior to obtaining taxi clearance and eliminates the need for stopping for that purpose after leaving the apron. Normally an entire apron can serve as a satisfactory altimeter check location.
- (c) The elevation of a pre-flight altimeter check location must be given as the average elevation, rounded to the nearest meter or foot, of the area on which it is located. The elevation of any portion of a pre-flight altimeter check location must be within 3 m (10 ft.) of the average elevation for that location.

### **§ 139.217 Declared Distances.**

- (a) The following distances must be calculated to the nearest meter or foot for a runway intended for use by international commercial air transport:
  - (1) Takeoff run available;
  - (2) Take-off distance available;
  - (3) Accelerate-stop distance available; and
  - (4) Landing distance available.

---

## GACAR PART 139 – CERTIFICATION, AUTHORIZATION AND OPERATION OF AERODROMES

---

### § 139.219 Condition of the Movement Area and Related Facilities.

- (a) Information on the condition of the movement area and the operational status of related facilities must be provided to the President, and similar information of operational significance to the air traffic services units, to enable those units to provide the necessary information to arriving and departing aircraft. The information must be kept up to date and changes in conditions reported without delay.
- (b) The condition of the movement area and the operational status of related facilities must be monitored and reports on matters of operational significance affecting aircraft, and aerodrome operations must be provided in order to take appropriate action, particularly in respect of the following:
- (1) Construction or maintenance work;
  - (2) Rough or broken surfaces on a runway, a taxiway or an apron;
  - (3) Water, snow, slush, ice, or frost on a runway, a taxiway or an apron;
  - (4) Anti-icing or de-icing liquid chemicals or other contaminants on a runway, taxiway or apron;
  - (5) Snowbanks or drifts adjacent to a runway, a taxiway or an apron;
  - (6) Other temporary hazards, including parked aircraft;
  - (7) Failure or irregular operation of part or all of the Aerodrome visual aids; and
  - (8) Failure of the normal or secondary power supply.

*Note 1. — Other contaminants may include mud, dust, sand, volcanic ash, oil, and rubber. Procedures for monitoring and reporting the conditions of the movement area are included in the ICAO PANS-Aerodromes (Doc 9981).*

*Note 2. — The ICAO Aeroplane Performance Manual (Doc 10064) provides guidance on aircraft performance calculation requirements regarding the description of runway surface conditions in § 139.219-(b)-(3), (5) and (6).*

*Note 3. — Origin and evolution of data, assessment process and the procedures are prescribed in the ICAO PANS-Aerodromes (Doc 9981). These procedures are intended to fulfil the requirements to achieve the desired level of safety for aeroplane operations prescribed by ICAO Annex 6 and*

---

## **GACAR PART 139 – CERTIFICATION, AUTHORIZATION AND OPERATION OF AERODROMES**

---

*Annex 8 and to provide the information fulfilling the syntax requirements for dissemination specified in ICAO Annex 15, the PANS-ATM (Doc 4444) and the PANS-AIM (Doc 10066).*

(c) To facilitate compliance with § 139.219 (a) and § 139.219 (b), the following inspections must be carried out each day:

(1) For the movement area, at least once where the aerodrome reference code number is 1 or 2 and at least twice where the aerodrome reference code number is 3 or 4; and

(2) For the runway(s), inspections in addition to (1) whenever the runway surface conditions may have changed significantly due to meteorological conditions.

*Note 1. — Procedures on carrying out daily inspections of the movement area are given in the PANS-Aerodromes (Doc 9981). Further guidance is available in the Airport Services Manual (Doc 9137), Part 8, and in the Manual of Surface Movement Guidance and Control Systems (SMGCS) (Doc 9476) and in the Advanced Surface Movement Guidance and Control Systems (A-SMGCS) Manual (Doc 9830).*

*Note 2. — The PANS-Aerodromes (Doc 9981) contains clarifications on the scope of a significant change in the runway surface conditions.*

(d) Personnel assessing, and reporting runway surface conditions required in § 139.219-(b) and 139.219-(e)-(1) must be trained and competent to perform their duties.

*Note 1. — Guidance on training of personal is given in Attachment A, Section 6 of Annex-14 Vol-I.*

*Note 2. — Information on training for personnel assessing and reporting runway surface conditions is available in the PANS-Aerodromes (Doc 9981).*

(e) Runway surface condition(s) for use in the runway condition report

*Introductory Note. - The philosophy of the runway condition report is that the Aerodrome operator assesses the runway surface conditions whenever water, snow, slush, ice or frost are present on an operational runway. From this assessment, a runway condition code (RWYCC) and a description of the runway surface are reported which can be used by the flight crew for aeroplane performance calculations. This report, based on the type, depth and coverage of contaminants, is the best assessment of the runway surface condition by the Aerodrome operator. However, all other pertinent information may be taken into consideration. Appendix E-2 for further details. The PANS-Aerodromes (Doc 9981) contains procedures on the use of the runway condition report and assignment of the RWYCC in accordance with the runway condition assessment matrix (RCAM).*

## **GACAR PART 139 – CERTIFICATION, AUTHORIZATION AND OPERATION OF AERODROMES**

---

- (1) The runway surface condition must be assessed and reported through a runway condition code (RWYCC) and a description using the following terms:

COMPACTED SNOW  
DRY  
DRY SNOW  
DRY SNOW ON TOP OF COMPACTED SNOW  
DRY SNOW ON TOP OF ICE  
FROST  
ICE  
SLUSH  
STANDING WATER  
WATER ON TOP OF COMPACTED SNOW  
WET  
WET ICE  
WET SNOW  
WET SNOW ON TOP OF COMPACTED SNOW  
WET SNOW ON TOP OF ICE  
CHEMICALLY TREATED  
LOOSE SAND

*Note 1. — The runway surface conditions are those conditions for which, by means of the methods described in the PANS-Aerodromes (Doc 9981), the flight crew can derive appropriate aeroplane performance.*

*Note 2. — The conditions, either singly or in combination with other observations, are criteria for which the effect on aeroplane performance is sufficiently deterministic to allow assignment of a specific runway condition code.*

*Note 3. — The terms CHEMICALLY TREATED and LOOSE SAND do not appear in the aeroplane performance section but are used in the situational awareness section of the runway condition report.*

- (2) Whenever an operational runway is contaminated, an assessment of the contaminant depth and coverage over each third of the runway shall be made and reported.

*Note. — Procedures on depth and coverage reporting are found in the PANS-Aerodromes (Doc 9981).*

---

## GACAR PART 139 – CERTIFICATION, AUTHORIZATION AND OPERATION OF AERODROMES

---

- (3) When friction measurements are used as part of the overall runway surface assessment on compacted snow - or ice-covered surfaces, the friction measuring device must meet the standard set or agreed by the President.
- (4) Friction measurements made on runway surface conditions with contaminants other than compacted snow and ice should not be reported.

*Note. — Friction measurements on loose contaminants such as snow and slush, in particular, are unreliable due to drag effects on the measurement wheel.*

- (5) Information that a runway or portion thereof is slippery wet must be made available.

*Note 1 - The surface friction characteristics of a runway or a portion thereof can be degraded due to rubber deposits, surface polishing, poor drainage, or other factors. The determination that a runway or portion thereof is slippery wet stems from various methods used solely or in combination. These methods may be functional friction measurements, using a continuous friction measuring device, that fall below a minimum standard as defined by the President, observations by Aerodrome maintenance personnel, repeated reports by pilots and aircraft operators based on flight crew experience, or through analysis of aeroplane stopping performance that indicates a substandard surface. Supplementary tools to undertake this assessment are described in the ICAO PANS-Aerodromes (Doc 9981).*

*Note 2. — See § 139.219-(a) and § 139.227 concerning the provision of information to, and coordination between, appropriate authorities.*

- (6) Notification must be given to relevant Aerodrome users when the friction level of a paved runway or portion thereof is less than the minimum friction level specified by the President in accordance with § 139.1003 (c).

*Note 1. — Guidance on determining and expressing the minimum friction level is provided in Assessment, Measurement and Reporting of Runway Surface conditions (Cir 355).*

*Note 2. — Procedures on conducting a runway surface friction characteristics evaluation programme are provided in the PANS-Aerodromes (Doc 9981).*

*Note 3. — Information to be promulgated in a NOTAM includes specifying which portion of the runway is below the minimum friction level and its location on the runway.*

---

## **GACAR PART 139 – CERTIFICATION, AUTHORIZATION AND OPERATION OF AERODROMES**

---

### **§ 139.221 Disabled aircraft removal.**

- (a) The telephone/telex number(s) of the office of the aerodrome coordinator of operations for the removal of an aircraft disabled on or adjacent to the movement area must be made available, on request, to aircraft operators.
- (b) Information concerning the capability to remove an aircraft disabled on or adjacent to the movement area must be made available, on request, to aircraft operators.

### **§ 139.223 Rescue and Fire Fighting.**

- (a) Information concerning the level of protection provided at an aerodrome for aircraft rescue and firefighting purposes must be made available.
- (b) The level of protection normally available at an aerodrome must be expressed in terms of the category of the rescue and firefighting services as described in § 139.903 and in accordance with the types and amounts of extinguishing agents normally available at the aerodrome.
- (c) Changes in the level of protection normally available at an aerodrome for rescue and firefighting must be notified to the appropriate air traffic services units and aeronautical information units to enable those units to provide the necessary information to arriving and departing aircraft. When such a change has been corrected, the above units must be advised accordingly.
- (d) A change must be expressed in terms of the new category of the rescue and firefighting service available at the aerodrome.

### **§ 139.225 Visual Approach Slope Indicator Systems.**

- (a) The following information concerning a visual approach slope indicator system installation must be made available:
  - (1) Associated runway designation number;
  - (2) Type of system according to § 139.505-(e)-(1)-(ii). For PAPI or APAPI installation, the side of the runway on which the lights are installed, i.e., left or right, must be given;
  - (3) Where the axis of the system is not parallel to the runway centre line, the angle of displacement and the direction of displacement, i.e., left or right must be indicated;
  - (4) Nominal approach slope angle(s). For a PAPI and an APAPI this must be angle  $(B + C) \div 2$  and  $(A + B) \div 2$ , respectively as in Figure H-18; and
  - (5) Minimum eye height(s) over the threshold of the on-slope signal(s). For PAPI this must be the setting angle of the third unit from the runway minus  $2'$ , i.e., angle B minus

---

## **GACAR PART 139 – CERTIFICATION, AUTHORIZATION AND OPERATION OF AERODROMES**

---

2', and for an APAPI this must be the setting angle of the unit farther from the runway minus 2', i.e., angle a minus 2'.

### **§ 139.227 Coordination between Aeronautical Information Services and Aerodrome Authorities.**

- (a) To ensure that aeronautical information services units obtain information to enable them to provide up-to-date-pre-flight information and to meet the need for in-flight information, arrangements must be made between aeronautical information services and Aerodrome authorities responsible for aerodrome services to report to the responsible aeronautical information services unit, with a minimum of delay:
- (1) Information on the status of certification of aerodromes and aerodrome conditions (ref. §139.103, §139.219, §139.221, § 139.223 and §139.225);
  - (2) The operational status of associated facilities, services and navigation aids within their area of responsibility; and
  - (3) Any other information considered to be of operational significance.
- (b) Before introducing changes to the air navigation system, due account must be taken by the services responsible for such changes of the time needed by the aeronautical information service for the preparation, production and issue of relevant material for promulgation. To ensure timely provision of the information to the aeronautical information service, close coordination between those services concerned is therefore required.
- (c) Of a particular importance are changes to aeronautical information that affect charts and/or computer-based navigation systems which qualify to be notified by the aeronautical information regulation and control (AIRAC) system, as specified in GACAR 175 SUBPART G. The predetermined, internationally agreed AIRAC effective dates must be observed by the responsible Aerodrome services when submitting the raw information/data to aeronautical information services.
- (d) The aerodrome services responsible for the provision of raw aeronautical information/data to the aeronautical information services must do that while considering accuracy and integrity requirements required to meet the needs of the end-user of aeronautical data.



**GACAR PART 139 – CERTIFICATION, AUTHORIZATION AND OPERATION OF  
AERODROMES**

---

**§ 139.229 Aeronautical charts.**

- (a) Unless authorized by the President, the Aerodrome operator must provide the following charts to the President for publication in the KSA AIP:
- (i) Aerodrome Obstacle Chart — ICAO Type A;
  - (ii) Precision Approach Terrain Chart — ICAO;
  - (iii) Instrument Approach Chart — ICAO;
  - (iv) Aerodrome/Aerodrome Chart — ICAO;
  - (v) Aerodrome Obstacle Chart — ICAO Type B ;
  - (vi) Aerodrome Ground Movement Chart — ICAO;
  - (vii) Aircraft Parking/Docking Chart — ICAO; and
  - (viii) Visual Approach Chart — ICAO

---

## GACAR PART 139 – CERTIFICATION, AUTHORIZATION AND OPERATION OF AERODROMES

---

### SUBPART F – PHYSICAL CHARACTERISTICS

#### § 139.301 Runways

- (a) Number and orientation of runways

*Introductory Note. — Many factors affect the determination of the orientation, siting and number of runways.*

*One important factor is the usability factor, as determined by the wind distribution, which is specified hereunder. Another important factor is the alignment of the runway to facilitate the provision of approaches conforming to the approach surface specifications of SUBPART G. In Appendix F-1, information is given concerning these and other factors.*

*When a new instrument runway is being located, particular attention needs to be given to areas over which aeroplanes will be required to fly when following instrument approach and missed approach procedures, to ensure that obstacles in these areas or other factors will not restrict the operation of the aeroplanes for which the runway is intended.*

- (1) The number and orientation of runways at an aerodrome must be such that the usability factor of the aerodrome is not less than 95 per cent for the aeroplanes that the aerodrome is intended to serve.
- (2) The siting and orientation of runways at an aerodrome must, where possible, be such that the arrival and departure tracks minimize interference with areas approved for residential use and other noise-sensitive areas close to the aerodrome in order to avoid future noise problems.

*Note. — Guidance on how to address noise problems is provided in the Airport Planning Manual (Doc 9184), Part 2, and in Guidance on the Balanced Approach to Aircraft Noise Management (Doc 9829).*

- (3) Choice of maximum permissible crosswind components:

In the application of § 139.301- (1) it must be assumed that landing or take-off of aeroplanes is, in normal circumstances, precluded when the cross-wind component exceeds:

---

## GACAR PART 139 – CERTIFICATION, AUTHORIZATION AND OPERATION OF AERODROMES

---

- (i) 37 km/h (20 kt) in the case of aeroplanes whose reference field length is 1,500 m or over, except that when poor runway braking action owing to an insufficient longitudinal coefficient of friction is experienced with some frequency, a crosswind component not exceeding 24 km/h (13 kt) must be assumed;
- (ii) 24 km/h (13 kt) in the case of aeroplanes whose reference field length is 1,200 m or up to but not including 1,500 m; and
- (iii) 19 km/h (10 kt) in the case of aeroplanes whose reference field length is less than 1,200 m.

*Note. — In Appendix F-1, guidance is given on factors affecting the calculation of the estimate of the usability factor and allowances which may have to be made to take account of the effect of unusual circumstances.*

- (4) Data to be used:

The selection of data to be used for the calculation of the usability factor must be based on reliable wind distribution statistics that extend over as long a period as possible, preferably of not less than five years. The observations used must be made at least eight times daily and spaced at equal intervals of time.

*Note. — These winds are mean winds. Reference to the need for some allowance for gusty conditions is made in Appendix F-1*

### (b) Location of threshold

- (1) A threshold must normally be located at the extremity of a runway unless operational considerations justify the choice of another location.

*Note. — Guidance on the siting of the threshold is given in ICAO Annex 14 Attachment A, Section 11.*

- (2) When it is necessary to displace a threshold, either permanently or temporarily, from its normal location, account must be taken of the various factors which may have a bearing on the location of the threshold. Where this displacement is due to an unserviceable runway condition, a cleared and graded area of at least 60 m in length must be available between the unserviceable area and the displaced threshold. Additional distance must also be provided to meet the requirements of the runway end safety area as appropriate.

---

## **GACAR PART 139 – CERTIFICATION, AUTHORIZATION AND OPERATION OF AERODROMES**

---

*Note. — Guidance on factors which may be considered in the determination of the location of a displaced threshold is given in ICAO Annex 14, Attachment A, Section 11.*

(c) Actual length of runways

(1) Primary runway

Except as provided in § 139.301-(c)-(3), the actual runway length to be provided for a primary runway must be adequate to meet the operational requirements of the aeroplanes for which the runway is intended and must be not less than the longest length determined by applying the corrections for local conditions to the operations and performance characteristics of the relevant aeroplanes.

*Note 1. — This specification does not necessarily mean providing for operations by the critical aeroplane at its maximum mass.*

*Note 2. — Both take-off and landing requirements need to be considered when determining the length of runway to be provided and the need for operations to be conducted in both directions of the runway.*

*Note 3. — Local conditions that need to be considered include elevation, temperature, runway slope and the runway surface characteristics.*

*Note 4. — When performance data on aeroplanes for which the runway is intended are not known, guidance on the determination of the actual length of a primary runway by application of general correction factors is given in the ICAO Aerodrome Design Manual (Doc 9157), Part 1.*

(2) Secondary runway

The length of a secondary runway must be determined similarly to primary runways except that it needs only to be adequate for those aeroplanes which require to use that secondary runway in addition to the other runway or runways in order to obtain a usability factor of at least 95 per cent.

(3) Runways with stopways or clearways

Where a runway is associated with a stopway or clearway, an actual runway length less than that resulting from application of § 139.301-(c)-(1) or § 139.301-(c)-(2), as appropriate, may be considered satisfactory, but in such a case any combination of runway, stopway and clearway provided must permit compliance with the operational

## GACAR PART 139 – CERTIFICATION, AUTHORIZATION AND OPERATION OF AERODROMES

requirements for take-off and landing of the aeroplanes the runway is intended to serve.

(d) Width of runways

- (1) The width of a runway must be not less than the appropriate dimension specified in the following tabulation:

| Outer Main Gear Wheel Span (OMGWS) |                               |                                   |                                 |                                  |
|------------------------------------|-------------------------------|-----------------------------------|---------------------------------|----------------------------------|
| Code number                        | Up to but not including 4.5 m | 4.5 m up to but not including 6 m | 6 m up to but not including 9 m | 9 m up to but not including 15 m |
| <i>1<sup>a</sup></i>               | <i>18 m</i>                   | <i>18 m</i>                       | <i>23 m</i>                     | –                                |
| <i>2<sup>a</sup></i>               | <i>23 m</i>                   | <i>23 m</i>                       | <i>30 m</i>                     | –                                |
| <i>3</i>                           | <i>30 m</i>                   | <i>30 m</i>                       | <i>30 m</i>                     | <i>45 m</i>                      |
| <i>4</i>                           | –                             | –                                 | <i>45 m</i>                     | <i>45 m</i>                      |

*a. The width of a precision approach runway should be not less than 30 m where the code number is 1 or 2.*

*Note 1. — The combinations of code numbers and OMGWS for which widths are specified have been developed for typical aeroplane characteristics.*

*Note 2. — Factors affecting runway width are given in the ICAO Aerodrome Design Manual (Doc 9157), Part 1.*

*Note 3. — See § 139.303 concerning the provision of runway shoulders, in particular for Code F aeroplanes with four (or more) engines.*

(e) Minimum distance between parallel runways

- (1) Where parallel non-instrument runways are intended for simultaneous use, the minimum distance between their center lines must be:

- (i) 210 m where the higher code number is 3 or 4;

---

## **GACAR PART 139 – CERTIFICATION, AUTHORIZATION AND OPERATION OF AERODROMES**

---

- (ii) 150 m where the higher code number is 2; and
  - (iii) 120 m where the higher code number is 1.
- (2) Where parallel instrument runways are intended for simultaneous use subject to conditions specified in the PANS-ATM (Doc 4444) and the PANS-OPS (Doc 8168), Volume I, the minimum distance between their center lines must be:
- (i) 1,035 m for independent parallel approaches;
  - (ii) 915 m for dependent parallel approaches;
  - (iii) 760 m for independent parallel departures;
  - (iv) 760 m for segregated parallel operations; except that:
    - (A) For segregated parallel operations, the specified minimum distance:
      - (I) Must be decreased by 30 m for each 150 m that the arrival runway is staggered toward the arriving aircraft, to a minimum of 300 m; and
      - (II) Must be increased by 30 m for each 150 m that the arrival runway is staggered away from the arriving aircraft;
    - (B) For independent parallel approaches, combinations of minimum distances and associated conditions other than those specified in the PANS-ATM (Doc 4444) may be applied when it is determined that such combinations would not adversely affect the safety of aircraft operations.
- (f) Slopes on runways
- (1) Longitudinal slopes

The slope computed by dividing the difference between the maximum and minimum elevation along the runway center line by the runway length must not exceed:

    - (i) 1 per cent where the code number is 3 or 4; and
    - (ii) 2 per cent where the code number is 1 or 2.
  - (2) Along no portion of a runway must the longitudinal slope exceed:

---

## **GACAR PART 139 – CERTIFICATION, AUTHORIZATION AND OPERATION OF AERODROMES**

---

- (i) 1.25 per cent where the code number is 4, except that for the first and last quarter of the length of the runway the longitudinal slope must not exceed 0.8 per cent;
  - (ii) 1.5 per cent where the code number is 3, except that for the first and last quarter of the length of a precision approach runway category II or III the longitudinal slope must not exceed 0.8 per cent; and
  - (iii) 2 per cent where the code number is 1 or 2.
- (3) Longitudinal slope changes
- Where slope changes cannot be avoided, a slope change between two consecutive slopes must not exceed:
- (i) 1.5 per cent where the code number is 3 or 4; and
  - (ii) 2 per cent where the code number is 1 or 2.
- (4) The transition from one slope to another must be accomplished by a curved surface with a rate of change not exceeding:
- (i) 0.1 per cent per 30 m (minimum radius of curvature of 30,000 m) where the code number is 4;
  - (ii) 0.2 per cent per 30 m (minimum radius of curvature of 15,000 m) where the code number is 3; and
  - (iii) 0.4 per cent per 30 m (minimum radius of curvature of 7,500 m) where the code number is 1 or 2.
- (5) Sight distance
- Where slope changes cannot be avoided, they must be such that there will be an unobstructed line of sight from:
- (i) Any point 3 m above a runway to all other points 3 m above the runway within a distance of at least half the length of the runway where the code letter is C, D, E or F.
  - (ii) Any point 2 m above a runway to all other points 2 m above the runway within a distance of at least half the length of the runway where the code letter is B; and

---

## GACAR PART 139 – CERTIFICATION, AUTHORIZATION AND OPERATION OF AERODROMES

---

- (iii) Any point 1.5 m above a runway to all other points 1.5m above the runway within a distance of at least half the length of the runway where the code letter is A.

*Note. — Consideration will have to be given to providing an unobstructed line of sight over the entire length of a single runway where a full-length parallel taxiway is not available. Where an Aerodrome has intersecting runways, additional criteria on the line of sight of the intersection area would need to be considered for operational safety. See the ICAO Aerodrome Design Manual (Doc 9157), Part 1.*

- (6) Distance between slope changes

Undulations or appreciable changes in slopes located close together along a runway must be avoided. The distance between the points of intersection of two successive curves must not be less than:

- (i) The sum of the absolute numerical values of the corresponding slope changes multiplied by the appropriate value as follows:
- (A) 30,000 m where the code number is 4;
  - (B) 15,000 m where the code number is 3; and
  - (C) 5,000 m where the code number is 1 or 2; or
- (ii) 45 m; Whichever is greater.

*Note. — Guidance on implementing this specification is given in Attachment A, Section 4.*

- (7) Transverse slopes

To promote the most rapid drainage of water, the runway surface must, if practicable, be cambered except where a single cross fall from high to low in the direction of the wind most frequently associated with rain would ensure rapid drainage. The transverse slope must ideally be:

- (i) 1.5 per cent where the code letter is C, D, E or F; and
- (ii) 2 per cent where the code letter is A or B;



---

## **GACAR PART 139 – CERTIFICATION, AUTHORIZATION AND OPERATION OF AERODROMES**

---

But in any event must not exceed 1.5 per cent or 2 per cent, as applicable, nor be less than 1 per cent except at runway or taxiway intersections where flatter slopes may be necessary.

For a cambered surface, the transverse slope on each side of the centre line must be symmetrical.

*Note.* — *On wet runways with crosswind conditions the problem of aquaplaning from poor drainage is apt to be accentuated. Additional guidance is included in the ICAO Aerodrome Design Manual (Doc 9157), Parts 1 and 3.*

- (8) The transverse slope must be substantially the same throughout the length of a runway except at an intersection with another runway or a taxiway where an even transition must be provided taking account of the need for adequate drainage.

### (g) Strength of runways

A runway must be capable of withstanding the traffic of aeroplanes the runway is intended to serve.

### (h) Surface of runways

- (1) The surface of a runway must be constructed without irregularities that would impair the runway surface in friction characteristics or otherwise adversely affect the take-off or landing of an aeroplane.

*Note 1.* — *Surface irregularities may adversely affect the take-off or landing of an aeroplane by causing excessive bouncing, pitching, vibration, or other difficulties in the control of an aeroplane.*

*Note 2.* — *Guidance on design tolerances and other information is given in Annex 14 Volume I, Attachment A, Section 5. Additional guidance is included in the Aerodrome Design Manual (Doc 9157), Part 3.*

- (2) A paved runway must be so constructed or resurfaced as to provide surface friction characteristics at or above the minimum friction level as per § 139.1003.
- (3) The surface of a paved runway must be evaluated when constructed or resurfaced to determine that the surface friction characteristics achieve the design objectives.

*Note.* — *Additional guidance is included in the ICAO Airport Services Manual (Doc 9137), Part 2.*

---

## **GACAR PART 139 – CERTIFICATION, AUTHORIZATION AND OPERATION OF AERODROMES**

---

- (4) Measurements of the surface friction characteristics of a new or resurfaced paved runway must be made with a continuous friction measuring device using self-wetting features.

*Note.* — *Additional guidance is included in the ICAO Airport Services Manual (Doc 9137), Part 2.*

- (5) The average surface texture depth of a new surface must be not less than 1.0 mm.

*Note 1.* — *Macro texture and micro textured are taken into consideration in order to provide the required surface friction characteristics. Guidance on surface design is given in Annex 14 Volume I, Attachment A, Section 8.*

*Note 2.* — *Guidance on methods used to measure surface texture is given in the ICAO Airport Services Manual (Doc 9137), Part 2.*

*Note 3.* — *Guidance on design and methods for improving surface texture is given in the ICAO Aerodrome Design Manual (Doc 9157), Part 3.*

- (6) When the surface is grooved or scored, the grooves or scorings must be either perpendicular to the runway centre line or parallel to non-perpendicular transverse joints, where applicable.

*Note.* — *Guidance on methods for improving the runway surface texture is given in the Aerodrome Design Manual (Doc 9157), Part 3.*

### **§ 139.303 Runway shoulders**

- (a) General

Runway shoulders must be provided for a runway where the code letter is D, E or F.

*Note.* — *Guidance on characteristics and treatment of runway shoulders is given in ICAO Annex 14 Volume I, Attachment A, Section 9, and in the Aerodrome Design Manual (Doc 9157), Part 1.*

- (b) Width of runway shoulders

For aeroplanes with OMGWS from 9 m up to but not including 15 m, the runway shoulders must extend symmetrically on each side of the runway so that the overall width of the runway and its shoulders is not less than:

---

## **GACAR PART 139 – CERTIFICATION, AUTHORIZATION AND OPERATION OF AERODROMES**

---

- (1) 60 m where the code letter is D or E;
- (2) 60 m where the code letter is F with two- or three-engine aeroplanes; and
- (3) 75 m where the code letter is F with four (or more)-engine aeroplanes.

(c) Slopes on runway shoulders

The surface of the shoulder that abuts the runway must be flush with the surface of the runway and its transverse slope must not exceed 2.5 per cent.

(d) Strength of runway shoulders

The portion of a runway shoulder between the runway edge and 30 m from the runway centre line must be prepared or constructed to be capable, in the event of an aeroplane running off the runway, of supporting the aeroplane without inducing structural damage to the aeroplane and of supporting ground vehicles which may operate on the shoulder.

*Note. — Guidance on strength of runway shoulders is given in the ICAO Aerodrome Design Manual (Doc 9157), Part 1.*

(e) Surface of runway shoulders

- (1) A runway shoulder must be prepared or constructed so as to resist erosion and the ingestion of the surface material by aeroplane engines.
- (2) Runway shoulders for code letter F aeroplanes must be paved to a minimum overall width of runway and shoulder of not less than 60 m.

*Note. — Guidance on surface of runway shoulders is given in the ICAO Aerodrome Design Manual, (Doc 9157), Part 1.*

### **§ 139.305 Runway turn pads**

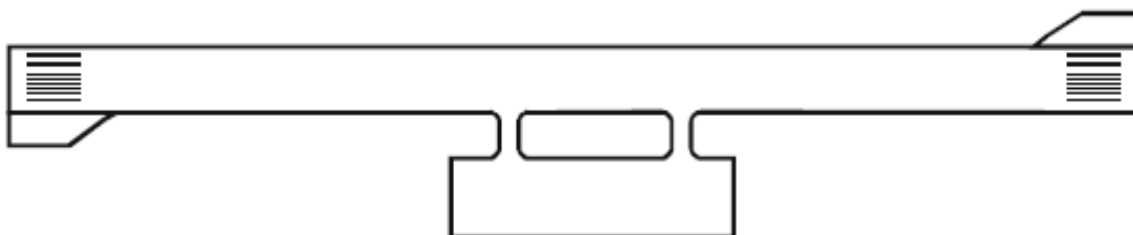
(a) General

- (1) Where the end of a runway is not served by a taxiway or a taxiway turnaround and where the code letter is D, E, or F a runway turn pad must be provided to facilitate a 180-degree turn of aeroplane (See figure F-1).

---

## GACAR PART 139 – CERTIFICATION, AUTHORIZATION AND OPERATION OF AERODROMES

---



**Figure F-1. Typical Turn Pad Layout**

- (2) Where the end of a runway is not served by a taxiway or a taxiway turnaround and where the code letter is A, B or C, a runway turn pad must be provided to facilitate a 180-degree turn of aeroplanes.
- (3) The runway turn pad must be located on either the right or left side of the runway and adjoining the runway pavement of both ends of the runway and at some intermediate locations where deemed necessary.

*Note. — The initiation of the turn would be facilitated by locating the turn pad on the left side of the runway, since the left seat is the normal position of the pilot-in-command.*

- (4) The intersection angle of the runway turn pad with runway must not exceed 30 degrees.
- (5) The nose wheel steering angle to be used in the design of the runway turn pad must not exceed 45 degrees.
- (6) The design of a runway turn pad must be such that, when the cockpit of the aeroplane for which the turn pad is intended remains over the turn pad marking, the clearance distance between any wheel of the aeroplane landing gear and the edge of the turn pad must be not less than that given by the following tabulation.

## GACAR PART 139 – CERTIFICATION, AUTHORIZATION AND OPERATION OF AERODROMES

|   | OMGWS                         |                                   |                                      |                                  |
|---|-------------------------------|-----------------------------------|--------------------------------------|----------------------------------|
|   | Up to but not including 4.5 m | 4.5 m up to but not including 6 m | 6 m up to but not including 9 m      | 9 m up to but not including 15 m |
| Clearance   | 1.50 m                        | 2.25 m                            | 3 m <sup>a</sup> or 4 m <sup>b</sup> | 4 m                              |
| <sup>a.</sup> <i>If the turn pad is intended to be used by aeroplanes with a wheel base less than 18 m.</i><br><sup>b.</sup> <i>If the turn pad is intended to be used by aeroplanes with a wheel base equal to or greater than 18 m.</i> |                               |                                   |                                      |                                  |

*Note.— Wheel base means the distance from the nose gear to the geometric centre of the main gear.*

### (b) Slopes on runway turn pads

The longitudinal and transverse slopes on a runway turn pad must be sufficient to prevent of the accumulation of water on the surface and facilitate rapid drainage of surface water. The slopes must be the same of those adjacent runway pavement surfaces.

### (c) Strength of the runway turn pad

The strength of the runway turn pad must be at least equal to that adjoining runway which it serves, due consideration being given to the fact that the turn pad will be subjected to slow – moving traffic making hard turns and consequent higher stresses on the pavement.

*Note. — Where a runway turn pad is provided with flexible pavement, the surface would need to be capable of withstanding the horizontal shear forces exerted by the main landing gear tires during turning maneuvers.*

### (d) Surface of runway turn pads

- (1) The surface of a runway turn pad must not have surface irregularities that may cause damage to an aeroplane using the turn pad.
- (2) The surface of a runway turn pad must be so constructed or resurfaced as to provide surface friction characteristics at least equal to that of the adjoining runway.

### (e) Shoulders for runway turn pads

- (1) The runway turn pads must be provided with shoulders of such width as is the necessary to prevent surface erosion by the jet blast of the most demanding aeroplane

---

## **GACAR PART 139 – CERTIFICATION, AUTHORIZATION AND OPERATION OF AERODROMES**

---

for which the turn pad is intended, and any possible foreign object damage to the aeroplane engines.

*Note. — As a minimum, the width of the shoulders would need to cover the outer engine of the most demanding aeroplane and thus may be wider than the associated runway shoulders.*

- (2) The strength of the runway turn pads shoulders must be capable of withstanding the occasional passage of the aeroplane it is designed to serve without inducing structural damage to the aeroplane and to the supporting ground vehicles that may operate on the shoulders.

### **§ 139.307 Runway strips**

#### (a) General

A runway and any associated stopways must be included in a strip.

#### (b) Length of runway strips

- (1) A strip must extend before the threshold and beyond the end of the runway or stopway for a distance of at least:
  - (2) 60 m where the code number is 2, 3 or 4;
  - (3) 60 m where the code number is 1 and the runway is instrument one; and
  - (4) 30 m where the code number is 1 and the runway is a non-instrument one.

#### (c) Width of runway strips

- (1) A strip including a precision approach runway must, wherever practicable, extend laterally to a distance of at least:
  - (i) 140 m where the code number is 3 or 4; and
  - (ii) 70 m where the code number is 1 or 2;

On each side of the center line of the runway and its extended center line throughout the length of the strip.

- (2) A strip including a non-precision approach runway must extend laterally to a distance of at least:

---

## GACAR PART 139 – CERTIFICATION, AUTHORIZATION AND OPERATION OF AERODROMES

---

- (i) 140 m where the code number is 3 or 4; and
- (ii) 70 m where the code number is 1 or 2;

On each side of the center line of the runway and its extended center line throughout the length of the strip.

- (3) A strip including a non-instrument runway must extend on each side of the center line of the runway and its extended center line throughout the length of the strip, to a distance of at least:
  - (i) 75 m where the code number is 3 or 4;
  - (ii) 40 m where the code number is 2; and
  - (iii) 30 m where the code number is 1

### (d) Objects on runway strips

*Note.* — See §139.917 for information regarding siting of equipment and installations on runway strips.

- (1) An object situated on a runway strip which may endanger aeroplanes must be regarded as an obstacle and must, as far as practicable, be removed.

*Note 1.* — Consideration will have to be given to the location and design of drains on a runway strip to prevent damage to an aeroplane accidentally running off a runway. Suitably designed drain covers may be required. For further guidance, see the ICAO Doc Aerodrome Design Manual (Doc 9157), Part 1.

*Note 2.* — Where open-air or covered storm water conveyances are installed, consideration will have to be given to ensure that their structure does not extend above the surrounding ground so as not to be considered an obstacle. See also Note 1 to §139.307-(f) - (4).

*Note 3.* — Particular attention needs to be given to the design and maintenance of an open-air storm water conveyance to prevent wildlife attraction, notably birds. If needed, it can be covered by a net. Guidance on wildlife control and reduction can be found in the Airport Services Manual (Doc 9137), Part 3.

- (2) No fixed object, other than visual aids required for air navigation or those required for aircraft safety purposes and which must be sited on the runway strip, and satisfying

---

## GACAR PART 139 – CERTIFICATION, AUTHORIZATION AND OPERATION OF AERODROMES

---

the relevant frangibility requirement in Subpart H, must be permitted on any part of a runway strip of a precision approach runway delineated by the lower edges of the inner transitional surfaces. No mobile object must be permitted on this part of the runway strip during the use of the runway for landing or take-off.

(e) Grading of runway strips

- (1) That portion of a strip of an instrument runway within a distance of at least:
  - (i) 75 m where the code number is 3 or 4; and
  - (ii) 40 m where the code number is 1 or 2;

From the center line of the runway and its extended center line must provide a graded area for aeroplanes which the runway is intended to serve in the event of an aeroplane running off the runway.

*Note. — Guidance on grading of a greater area of a strip including a precision approach runway where the code number is 3 or 4 is given in Appendix F-2.*

- (2) That portion of a strip of a non-instrument runway within a distance of at least:
  - (i) 75 m where the code number is 3 or 4;
  - (ii) 40 m where the code number is 2; and
  - (iii) 30 m where the code number is 1;

From the center line of the runway and its extended center line must provide a graded area for aeroplanes which the runway is intended to serve in the event of an aeroplane running off the runway.

- (3) The surface of that portion of a strip that abuts a runway, shoulder or stopway must be flush with the surface of the runway, shoulder or stopway.
- (4) That portion of a strip to at least 30 m before the start of a runway must be prepared against blast erosion to protect a landing aeroplane from the danger of an exposed edge.
- (5) Where the areas in § 139.307-(e)-(4) have paved surfaces, they must be able to withstand the occasional passage of the critical aeroplane for runway pavement design.



---

## **GACAR PART 139 – CERTIFICATION, AUTHORIZATION AND OPERATION OF AERODROMES**

---

*Note: Refer Appendix F-2 for guidance on grading of a greater area including a precision approach runway where the code number is 3 or 4.*

(f) Slopes on runway strips

(1) Longitudinal slopes

A longitudinal slope along that portion of a strip to be graded must not exceed:

- (i) 1.5 per cent where the code number is 4;
- (ii) 1.75 per cent where the code number is 3; and
- (iii) 2 per cent where the code number is 1 or 2.

(2) Longitudinal Slope changes

Slope changes on that portion of a strip to be graded must be as gradual as practicable and abrupt changes or sudden reversals of longitudinal slopes avoided.

(3) Transverse slopes

Transverse slopes on that portion of a strip to be graded must be adequate to prevent the accumulation of water on the surface but must not exceed:

- (i) 2.5 per cent where the code number is 3 or 4; and
- (ii) 3 per cent where the code number is 1 or 2;

Except that to facilitate drainage the slope for the first 3 m outward from the runway, shoulder or stopway edge must be negative as measured in the direction away from the runway and may be as great as 5 per cent.

(4) The transverse slopes of any portion of a strip beyond that to be graded must not exceed an upward slope of 5 per cent as measured in the direction away from the runway.

*Note 1. — Where deemed necessary for proper drainage, an open-air storm water conveyance may be allowed in the non-graded portion of a runway strip and would be placed as far as practicable from the runway.*

---

## **GACAR PART 139 – CERTIFICATION, AUTHORIZATION AND OPERATION OF AERODROMES**

---

*Note 2. — The Aerodrome rescue and firefighting (RFF) procedure would need to take into account the location of open air water conveyances within the non-graded portion of a runway strip.*

**(g) Strength of runway strips**

(1) That portion of a strip of an instrument runway within a distance of at least:

- (i) 75 m where the code number is 3 or 4; and
- (ii) 40 m where the code number is 1 or 2;

From the centre line of the runway and its extended centre line must be so prepared or constructed as to minimize hazards arising from differences in load bearing capacity to aeroplanes which the runway is intended to serve in the event of an aeroplane running off the runway.

(2) That portion of a strip containing a non-instrument runway within a distance of at least:

- (i) 75 m where the code number is 3 or 4;
- (ii) 40 m where the code number is 2; and 30 m where the code number is 1;

From the centre line of the runway and its extended centre line must be so prepared or constructed as to minimize hazards arising from differences in load bearing capacity to aeroplanes which the runway is intended to serve in the event of an aeroplane running off the runway.

*Note. — Guidance on preparation of runway strips is given in the Appendix F-3 of this part for Guidance on preparation of the runway strip.*

### **§ 139.309 Runway end safety areas**

**(a) General**

(1) A runway end safety area must be provided at each end of a runway strip where:

- (i) The code number is 3 or 4; and
- (ii) The code number is 1 or 2 and the runway is an instrument one.

(2) A runway end safety area must be provided at each end of a runway strip where the code number is 1 or 2 and the runway is a non-instrument one.

---

## **GACAR PART 139 – CERTIFICATION, AUTHORIZATION AND OPERATION OF AERODROMES**

---

### (b) Dimensions of runway end safety areas

- (1) A runway end safety area must extend from the end of a runway strip to a distance of at least 90 m where:
  - (i) The code number is 3 or 4; and
  - (ii) The code number is 1 or 2 and the runway is an instrument one.

If an arresting system is installed, the above length may be reduced, based on the design specification of the system, subject to acceptance by the President.

- (2) A runway end safety area should, as far as practicable, extend from the end of a runway strip to a distance of at least:
  - (i) 240 m where the code number is 3 or 4; or a reduced length when an arresting system is installed;
  - (ii) 120 m where the code number is 1 or 2 and the runway is an instrument one; or a reduced length when an arresting system is installed; and
  - (iii) 30 m where the code number is 1 or 2 and the runway is a non-instrument one.
- (3) The width of a runway end safety area must be at least twice that of the associated runway.
- (4) The width of a runway end safety area must, wherever practicable, be equal to that of the graded portion of the associated runway strip.

*Note: - Refer Appendix F-4 for guidance on runway end safety area.*

### (c) Objects on runway end safety areas

An object situated on a runway end safety area which may endanger aeroplanes must be regarded as an obstacle and must be removed.

*Note. — See § 139.917 for information regarding siting of equipment and installations on runway end safety areas.*

### (d) Clearing and grading of runway end safety areas

---

## **GACAR PART 139 – CERTIFICATION, AUTHORIZATION AND OPERATION OF AERODROMES**

---

A runway end safety area must provide a cleared and graded area for aeroplane which the runway is intended to serve in the event of an aeroplane undershooting or overrunning the runway.

(e) Slopes on runway end safety areas

(1) General:

The slopes of a runway end safety area must be such that no part of the runway end safety area penetrates the approach or take-off climb surface.

(2) Longitudinal slopes:

The longitudinal slopes of a runway end safety area must not exceed a downward slope of 5 percent. Longitudinal slope changes must be as gradual as practicable and abrupt changes or sudden reversals of slopes avoided.

(3) Transverse slopes:

The transverse slopes of a runway end safety area must not exceed an upward or downward slope of 5 per cent. Transitions between differing slopes must be as gradual as practicable.

(f) Strength of runway end safety areas

A runway end safety area must be so prepared or constructed as to reduce the risk of damage to an aeroplane undershooting or overrunning the runway, enhance aeroplane deceleration and facilitate the movement of rescue and fire fighting vehicles as required in § 139.903-(f)-(1) to § 139.903-(f)-(3).

*Note. — Guidance on the strength of a runway end safety area is given in the Appendix F-5 for guidance on the strength of runway end safety area.*

### **§ 139.311 Clearways**

*Note. — The inclusion of detailed specifications for clearways in this section is not intended to imply that a clearway has to be provided in ICAO Annex 14 Volume I. Attachment A, Section 2, provides information on the use of clearways.*

---

## **GACAR PART 139 – CERTIFICATION, AUTHORIZATION AND OPERATION OF AERODROMES**

---

(a) Location of clearways

The origin of a clearway must be at the end of the take-off run available.

(b) Length of clearways

The length of a clearway must not exceed half the length of the take-off run available.

(c) Width of clearways

A clearway must extend laterally on each side of the extended centerline of the runway, to a distance of at least;

- (1) 75 m for instrument runways; and
- (2) Half of the width of the runway strip for non-instruments runways

(d) Slopes on clearways

- (1) The ground in a clearway must not project above a plane having an upward slope of 1.25 per cent, the lower limit of this plane being a horizontal line which:
  - (i) is perpendicular to the vertical plane containing the runway centre line; and
  - (ii) passes through a point located on the runway center line at the end of the take-off run available.
- (2) Abrupt upward changes in slope must be avoided when the slope on the ground in a clearway is relatively small or when the mean slope is upward. In such situations, in that portion of the clearway within 22.5 m or half the runway width whichever is greater on each side of the extended center line, the slopes, slope changes and the transition from runway to clearway must generally conform to those of the runway with which the clearway is associated.

(e) Objects on clearways

An object situated on a clearway which may endanger aeroplanes in the air must be regarded as an obstacle and must be removed.

*Note. — See § 139.917 for information regarding siting of equipment and installations on clearways.*

---

## **GACAR PART 139 – CERTIFICATION, AUTHORIZATION AND OPERATION OF AERODROMES**

---

### **§ 139.313 Stopways**

#### (a) Width of stopways

A stopway must have the same width as the runway with which it is associated.

#### (b) Slopes on stopways

Slopes and changes in slope on a stopway, and the transition from a runway to a stopway, must comply with the specifications of § 139.301-(f)-(1) to § 139.301-(f)-(7) for the runway with which the stopway is associated except that:

- (1) The limitation in § 139.301-(f)-(2) of a 0.8 per cent slope for the first and last quarter of the length of a runway need not be applied to the stopway; and
- (2) At the junction of the stopway and runway and along the stopway the maximum rate of slope change may be 0.3 per cent per 30 m (minimum radius of curvature of 10,000 m) for a runway where the code number is 3 or 4.

#### (c) Strength of stopways

A stopway must be prepared or constructed so as to be capable, in the event of an abandoned take-off, of supporting the aeroplane which the stopway is intended to serve without inducing structural damage to the aeroplane.

#### (d) Surface of stopways

The surface of a paved stopway must be so constructed or resurfaced as to provide surface friction characteristics at or above those of the associated runway.

### **§ 139.315 Radio altimeter operating area**

#### (a) General

A radio altimeter operating area must be established in the pre-threshold area of a precision approach runway.

#### (b) Length of the area

A radio altimeter operating area must extend before the threshold for a distance of at least 300 m.

---

## **GACAR PART 139 – CERTIFICATION, AUTHORIZATION AND OPERATION OF AERODROMES**

---

(c) Width of the area

A radio altimeter operating area must extend laterally, on each side of the extended centre line of the runway, to a distance of 60 m, except that, when special circumstances so warrant, the distance may be reduced to no less than 30 m if an aeronautical study indicates that such reduction would not affect the safety of operations of aircraft.

(d) Longitudinal slope changes

On a radio altimeter operating area, slope changes must be avoided or kept to a minimum. Where slope changes cannot be avoided, the slope changes must be as gradual as practicable and abrupt changes or sudden reversals of slopes avoided. The rate of change between two consecutive slopes must not exceed 2 per cent per 30 m.

### **§ 139.317 Taxiways**

(a) General

- (1) Taxiways must be provided to permit the safe and expeditious surface movement of aircraft.
- (2) Sufficient entrance and exit taxiways for a runway must be provided to expedite the movement of aeroplanes to and from the runway and provision of rapid exit taxiways considered when traffic volumes are high.
- (3) The design of a taxiway must be such that, when the cockpit of the aeroplane for which the taxiway is intended remains over the taxiway centre line markings, the clearance distance between the outer main wheel of the aeroplane and the edge of the taxiway must be not less than that given by the following tabulation:

## GACAR PART 139 – CERTIFICATION, AUTHORIZATION AND OPERATION OF AERODROMES

| OMGWS     |                               |                                   |  |                                  |
|-----------|-------------------------------|-----------------------------------|--|----------------------------------|
|           | Up to but not including 4.5 m | 4.5 m up to but not including 6 m | 6 m up to but not including 9 m        | 9 m up to but not including 15 m |
| Clearance | 1.50 m                        | 2.25 m                            | 3 m <sup>a,b</sup> or 4 m <sup>c</sup> | 4 m                              |

<sup>a.</sup> On straight portions.

<sup>b.</sup> On curved portions if the taxiway is intended to be used by aeroplanes with a wheel base of less than 18 m.

<sup>c.</sup> On curved portions if the taxiway is intended to be used by aeroplanes with a wheel base equal to or greater than 18 m.

*Note.— Wheel base means the distance from the nose gear to the geometric centre of the main gear.*

### (b) Width of taxiways

A straight portion of a taxiway must have a width of not less than that given by the following tabulation:

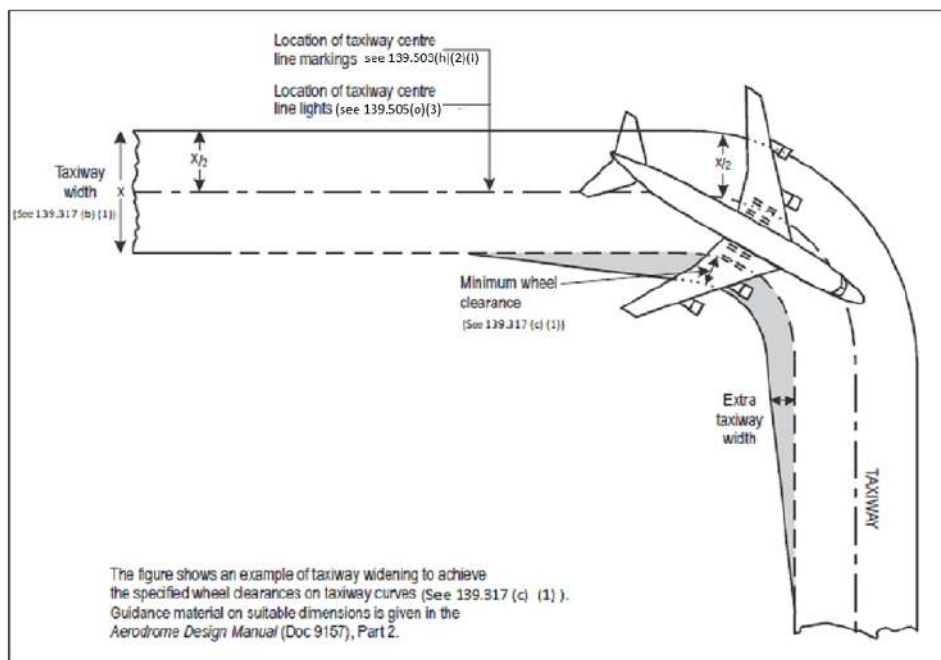
| OMGWS         |                               |                                   |                                 |                                  |
|---------------|-------------------------------|-----------------------------------|---------------------------------|----------------------------------|
|               | Up to but not including 4.5 m | 4.5 m up to but not including 6 m | 6 m up to but not including 9 m | 9 m up to but not including 15 m |
| Taxiway width | 7.5 m                         | 10.5 m                            | 15 m                            | 23 m                             |

### (c) Taxiway curves

Changes in direction of taxiways must be as few and small as possible. The radii of the curves must be compatible with the maneuvering capability and normal taxiing speeds of the aeroplanes for which the taxiway is intended. The design of the curve must be such that, when the cockpit of the aeroplane remains over the taxiway center line markings, the clearance distance between the outer main wheels of the aeroplane and the edge of the taxiway must not be less than those specified in § 139.317-(a)-(3).



## GACAR PART 139 – CERTIFICATION, AUTHORIZATION AND OPERATION OF AERODROMES



**Figure F-2. Taxiway Curve**

(d) Junctions and intersections

To facilitate the movement of aeroplanes, fillets must be provided at junctions and intersections of taxiways with runways, aprons, and other taxiways. The design of the fillets must ensure that the minimum wheel clearances specified in § 139.317-(a)-(3) are maintained when aeroplanes are maneuvering through the junctions or intersections.

*Note.* — Consideration will have to be given to the aeroplane datum length when designing fillets. Guidance on the design of fillets and the definition of the term aeroplane datum length are given in the *Aerodrome Design Manual (Doc 9157), Part 2*.

(e) Taxiway minimum separation distances

The separation distance between the centre line of a taxiway and the centre line of a runway, the centre line of a parallel taxiway or an object must not be less than the appropriate dimension specified in Table F-1, except that it may be permissible to operate with lower separation distances at an existing Aerodrome if an aeronautical study indicates that such lower separation distances

## GACAR PART 139 – CERTIFICATION, AUTHORIZATION AND OPERATION OF AERODROMES

would not adversely affect the safety or significantly affect the regularity of operations of aeroplanes.

| Code letter | Distance between taxiway centre line and runway centre line (metres) |               |               |               |                        |               |               |               | Taxiway centre line to taxiway centre line (metres) | Taxiway, other than aircraft stand taxilane, centre line to object (metres) | Aircraft stand centre line to aircraft stand taxilane centre line (metres) | Aircraft stand taxilane centre line to object (metres) |
|-------------|--|---------------|---------------|---------------|------------------------|---------------|---------------|---------------|---|---|--|--|
|             | Instrument runways   |               |               |               | Non-instrument runways |               |               |               |   |   |  |  |
|             | Code number 1  | Code number 2 | Code number 3 | Code number 4 | Code number 1          | Code number 2 | Code number 3 | Code number 4 |   |   |  |  |
| (1)         | (2)  | (3)           | (4)           | (5)           | (6)                    | (7)           | (8)           | (9)           | (10)  | (11)  | (12)   | (13)   |
| A           | 77.5   | 77.5          | –             | –             | 37.5                   | 47.5          | –             | –             | 23  | 15.5  | 19.5   | 12   |
| B           | 82   | 82            | 152           | –             | 42                     | 52            | 87            | –             | 32  | 20  | 28.5   | 16.5   |
| C           | 88   | 88            | 158           | 158           | 48                     | 58            | 93            | 93            | 44  | 26  | 40.5   | 22.5   |
| D           | –  | –             | 166           | 166           | –                      | –             | 101           | 101           | 63  | 37  | 59.5   | 33.5   |
| E           | –  | –             | 172.5         | 172.5         | –                      | –             | 107.5         | 107.5         | 76  | 43.5  | 72.5   | 40   |
| F           | –  | –             | 180           | 180           | –                      | –             | 115           | 115           | 91  | 51  | 87.5   | 47.5   |

Table F-1. Taxiway Minimum Separation Distances

(f) Slopes on taxiways

(1) Longitudinal slopes

The longitudinal slope of a taxiway must not exceed:

- (i) 1.5 per cent where the code letter is C, D, E or F; and
- (ii) 3 per cent where the code letter is A or B.

(2) Longitudinal slope changes

Where slope changes on a taxiway cannot be avoided, the transition from one slope to another slope must be accomplished by a curved surface with a rate of change not exceeding:

- (i) 1 per cent per 30 m (minimum radius of curvature of 3,000 m) where the code letter is C, D, E or F; and

## **GACAR PART 139 – CERTIFICATION, AUTHORIZATION AND OPERATION OF AERODROMES**

- (ii) 1 per cent per 25 m (minimum radius of curvature of 2,500 m) where the code letter is A or B.

(3) Sight distance

Where a change in slope on a taxiway cannot be avoided, the change must be such that, from any point:

- (i) 3 m above the taxiway, it will be possible to see the whole surface of the taxiway for a distance of at least 300 m from that point, where the code letter is C, D, E or F;
- (ii) 2 m above the taxiway, it will be possible to see the whole surface of the taxiway for a distance of at least 200 m from that point, where the code letter is B; and
- (iii) 1.5 m above the taxiway, it will be possible to see the whole surface of the taxiway for a distance of at least 150 m from that point, where the code letter is A.

(4) Transverse slopes

The transverse slopes of a taxiway must be sufficient to prevent the accumulation of water on the surface of the taxiway but must not exceed:

- (i) 1.5 per cent where the code letter is C, D, E or F; and
- (ii) 2 per cent where the code letter is A or B.

(g) Strength of taxiways

The strength of a taxiway must be at least equal to that of the runway it serves, due consideration being given to the fact that a taxiway will be subjected to a greater density of traffic and, because of slow moving and stationary aeroplanes, to higher stresses than the runway it serves.

(h) Surface of taxiways

- (1) The surface of a taxiway must not have irregularities that cause damage to aeroplane structures.
- (2) The surface of a paved taxiway must be so constructed or resurfaced as to provide suitable surface friction characteristics. Refer § 139.1003 (c) for minimum friction value.

## GACAR PART 139 – CERTIFICATION, AUTHORIZATION AND OPERATION OF AERODROMES

### (i) Rapid exit taxiways

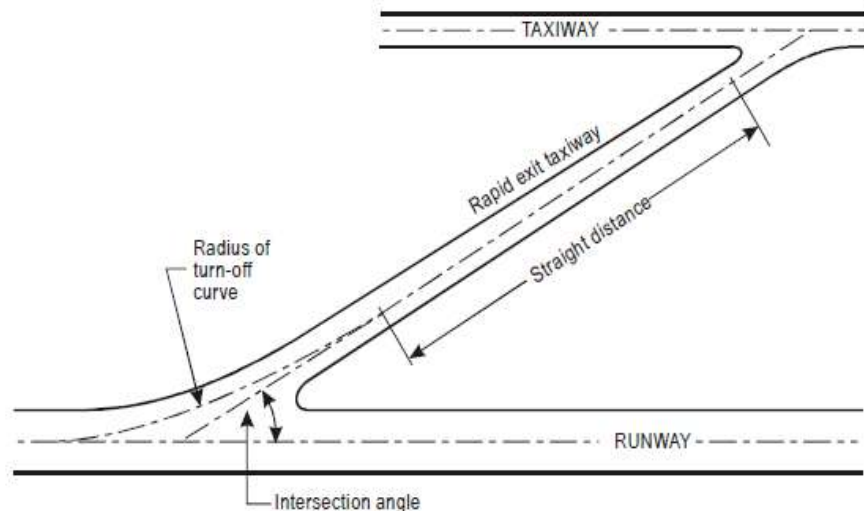
(1) A rapid exit taxiway must be designed with a radius of turn-off curve of at least:

- (i) 550 m where the code number is 3 or 4; and
- (ii) 275 m where the code number is 1 or 2;

To enable exit speeds under wet conditions of:

- (A) 93 km/h where the code number is 3 or 4; and
- (B) 65 km/h where the code number is 1 or 2

- (2) The radius of the fillet on the inside of the curve at a rapid exit taxiway must be sufficient to provide a widened taxiway throat to facilitate early recognition of the entrance and turn-off onto the taxiway.
- (3) A rapid exit taxiway must include a straight distance after the turn-off curve sufficient for an exiting aircraft to come to a full stop clear of any intersecting taxiway.
- (4) The intersection angle of a rapid exit taxiway with the runway must not be greater than  $45^\circ$  nor less than  $25^\circ$  and preferably must be  $30^\circ$ .



**Figure F-3. Rapid Exit Taxiway**

---

## **GACAR PART 139 – CERTIFICATION, AUTHORIZATION AND OPERATION OF AERODROMES**

---

### **(j) Taxiways on bridges**

- (1) The width of that portion of a taxiway bridge capable of supporting aeroplanes, as measured perpendicularly to the taxiway centre line, must not be less than the width of the graded area of the strip provided for that taxiway, unless a proven method of lateral restraint is provided which must not be hazardous for aeroplanes for which the taxiway is intended.
- (2) Access must be provided to allow rescue and fire fighting vehicles to intervene in both directions within the specified response time to the largest aeroplane for which the taxiway bridge is intended.
- (3) A bridge must be constructed on a straight section of the taxiway with a straight section on both ends of the bridge to facilitate the alignment of aeroplanes approaching the bridge.

### **§ 139.319 Taxiway shoulders**

- (a) Straight portions of a taxiway where the code letter is C, D, E or F must be provided with shoulders which extend symmetrically on each side of the taxiway so that the overall width of the taxiway and its shoulders on straight portions is not less than:
  - (1) 44 m where the code letter is F;
  - (2) 38 m where the code letter is E;
  - (3) 34 m where the code letter is D; and
  - (4) 25 m where the code letter is C.

On taxiway curves and on junctions or intersections where increased pavement is provided, the shoulder width must be not less than that on the adjacent straight portions of the taxiway.

- (b) When a taxiway is intended to be used by turbine-engine aeroplanes, the surface of the taxiway shoulder must be so prepared as to resist erosion and the ingestion of the surface material by aeroplane engines.

---

## GACAR PART 139 – CERTIFICATION, AUTHORIZATION AND OPERATION OF AERODROMES

---

### § 139.321 Taxiway strips

(a) General

A taxiway, other than an aircraft stand taxi lane, must be included in a strip.

(b) Width of taxiway strips

A taxiway strip must extend symmetrically on each side of the centre line of the taxiway throughout the length of the taxiway to at least the distance from the centre line given in Table F-1, column 11.

(c) Objects on taxiway strips

The taxiway strip must provide an area clear of objects which may endanger taxiing aeroplanes.

*Note.* — See § 139.17 for information regarding siting of equipment and installations on taxiway strips.

(d) Grading of taxiway strips

The centre portion of a taxiway strip must provide a graded area to a distance from the centre line of the taxiway of not less than that given by the following tabulation:

- (1) 10.25 m where the OMGWS is up to but not including 4.5 m;
- (2) 11 m where the OMGWS is 4.5 m up to but not including 6 m;
- (3) 12.50 m where the OMGWS is 6 m up to but not including 9 m;
- (4) 18.50 m where the OMGWS is 9 m up to but not including 15 m, where the code letter is D;
- (5) 19 m where the OMGWS is 9 m up to but not including 15 m, where the code letter is E; and:
- (6) 22 m where the OMGWS is 9 m up to but not including 15 m, where the code letter is F.

---

## **GACAR PART 139 – CERTIFICATION, AUTHORIZATION AND OPERATION OF AERODROMES**

---

### (e) Slopes on taxiway strips

- (1) The surface of the strip must be flush at the edge of the taxiway or shoulder, if provided, and the graded portion must not have an upward transverse slope exceeding:
  - (i) 2.5 per cent for strips where the code letter is C, D, E or F; and
  - (ii) 3 per cent for strips of taxiways where the code letter is A or B;

The upward slope being measured with reference to the transverse slope of the adjacent taxiway surface and not the horizontal. The downward transverse slope must not exceed 5 per cent measured with reference to the horizontal.

- (2) The transverse slopes on any portion of a taxiway strip beyond that to be graded must not exceed an upward or downward slope of 5 per cent as measured in the direction away from the taxiway.

### **§ 139.323 Holding bays, runway-holding positions, intermediate holding positions and road-holding positions**

#### (a) General

- (1) Holding bay(s) must be provided when the traffic density is medium or heavy.
- (2) A runway-holding position or positions must be established:
  - (i) On the taxiway, at the intersection of a taxiway and a runway; and
  - (ii) At an intersection of a runway with another runway when the former runway is part of a standard taxi-route.
- (3) A runway-holding position must be established on a taxiway if the location or alignment of the taxiway is such that a taxiing aircraft or vehicle can infringe an obstacle limitation surface or interfere with the operation of radio navigation aids.
- (4) An intermediate holding position must be established on a taxiway at any point other than a runway-holding position where it is desirable to define a specific holding limit.
- (5) A road-holding position must be established at an intersection of a road with a runway.

#### (b) Location

## GACAR PART 139 – CERTIFICATION, AUTHORIZATION AND OPERATION OF AERODROMES

- (1) The distance between a holding bay, runway-holding position established at a taxiway/runway intersection or road-holding position and the centre line of a runway must be in accordance with Table F-2 and, in the case of a precision approach runway, such that a holding aircraft or vehicle will not interfere with the operation of radio navigation aids or penetrate the inner transitional surface.
- (2) At elevations greater than 700 m (2,300 ft.) the distance of 90 m specified in Table F-2 for a precision approach runway code number 4 must be increased as follows:
  - (i) Up to an elevation of 2,000 m (6,600 ft.); 1 m for every 100 m (330 ft.) in excess of 700 m (2,300 ft.);
  - (ii) Elevation in excess of 2,000 m (6,600 ft.) and up to 4,000 m (13,320 ft.); 13 m plus 1.5 m for every 100 m (330 ft.) in excess of 2,000 m (6,600 ft.); and
  - (iii) Elevation in excess of 4,000 m (13,320 ft.) and up to 5,000 m (16,650 ft.); 43 m plus 2 m for every 100 m (330 ft.) in excess of 4,000 m (13,320 ft.).
- (3) If a holding bay, runway holding position or road-holding position for a precision approach runway code number 4 is at a greater elevation compared to the threshold, the distance, specified in Table F-2 must be further increased 5 m for every meter the bay or position is higher than the threshold.
- (4) The location of a runway-holding position established in accordance with § 139.323-(a)-(3) must be such that a holding aircraft or vehicle will not infringe the obstacle free zone, approach surface, take-off climb surface or ILS/MLS critical/sensitive area or interfere with the operation of radio navigation aids.

| Type of runway                           | Code number       |                   |                     |                       |
|--|-------------------|-------------------|---------------------|-----------------------|
|  | 1                 | 2                 | 3                   | 4                     |
| Non-instrument                           | 30 m              | 40 m              | 75 m                | 75 m                  |
| Non-precision approach                   | 40 m              | 40 m              | 75 m                | 75 m                  |
| Precision approach category I            | 60 m <sup>b</sup> | 60 m <sup>b</sup> | 90 m <sup>a,b</sup> | 90 m <sup>a,b,c</sup> |
| Precision approach categories II and III | —                 | —                 | 90 m <sup>a,b</sup> | 90 m <sup>a,b,c</sup> |
| Take-off runway                          | 30 m              | 40 m              | 75 m                | 75 m                  |

**Table F-2. Minimum distance from Runway centre line to a holding bay, runway-holding position or road-holding position**



---

## **GACAR PART 139 – CERTIFICATION, AUTHORIZATION AND OPERATION OF AERODROMES**

---

- (i) If holding bay, runway-holding position or road-holding position is at a lower elevation to the threshold, the distance may be decreased 5m for every metre the bay or holding position is lower than the threshold, contingent upon not infringing the inner transitional surface.
- (ii) The distance may need to be increased to avoid interference with radio navigation aids, particularly the glide path and localizer facilities. Information on critical and sensitive areas of ILS and MLS is contained in Annex 10, Volume I, Attachments C and G, respectively. See also 139.323 (b) (1).

*Note 1. The distance of 90m for code number 3 or 4 is based on an aircraft with a tail height of 30m, a distance from the nose to the highest part of the tail of 52,7m and a nose height of 10m holding at an angle of 45° or more with respect to the runway centre line, being clear of the obstacle free zone and not accountable for the calculation of OCA/H.*

*Note 2. The distance of 60m for code number 2 is based on an aircraft with a tail height of 8m, a distance from the nose to the highest part of the tail of 24.6m and a nose of 5.2m holding at an angle of 45° or more with respect to the runway centre line, being clear of the obstacle free zone.*

*Note 3. For code number 4 where the width of the inner edge of the inner approach surface is more than 120 m, a distance greater than 90 m may be necessary to ensure that a holding aircraft is clear of the obstacle free zone. For example, a distance of 100 m based on an aircraft with a tail height of 24m, a distance from the nose to the highest part of the tail of 62.2 m and a nose height of 10m holding at an angle of 45° or more with respect to the runway centre line, being clear of the obstacle free zone.*

### **§ 139.325 Aprons**

#### **(a) General**

Aprons must be provided where necessary to permit the on- and off-loading of passengers, cargo, or mail as well as the servicing of aircraft without interfering with the Aerodrome traffic.

#### **(b) Size of aprons**

The total apron area must be adequate to permit expeditious handling of the Aerodrome traffic at its maximum anticipated density.

#### **(c) Strength of aprons**

---

## **GACAR PART 139 – CERTIFICATION, AUTHORIZATION AND OPERATION OF AERODROMES**

---

Each part of an apron must be capable of withstanding the traffic of the aircraft it is intended to serve, due consideration being given to the fact that some portions of the apron will be subjected to a higher density of traffic and, as a result of slow moving or stationary aircraft, to higher stresses than a runway.

(d) Slopes on aprons

- (1) Slopes on an apron, including those on an aircraft stand taxi lane, must be sufficient to prevent accumulation of water on the surface of the apron but must be kept as level as drainage requirements permit.
- (2) On an aircraft stand the maximum slope must not exceed 1 per cent.

(e) Clearance distances on aircraft stands

An aircraft stand must provide the following minimum clearances between an aircraft entering or exiting the stand and any adjacent building, aircraft on another stand and other objects:

| Code letter | Clearance |
|-------------|-----------|
| A           | 3 m       |
| B           | 3 m       |
| C           | 4.5 m     |
| D           | 7.5 m     |
| E           | 7.5 m     |
| F           | 7.5 m     |

When special circumstances so warrant, these clearances may be reduced at a nose –in aircraft stand, where the code letter is D, E, or F:

- (1) Between the terminal, including any fixed passenger bridge, and the nose of an aircraft; and

## **GACAR PART 139 – CERTIFICATION, AUTHORIZATION AND OPERATION OF AERODROMES**

- (2) Over any portion of the stand provided with azimuth guidance by a visual docking guidance system.

### **§ 139.327 Isolated aircraft parking positions**

- (a) An isolated aircraft parking position must be designated, or the Aerodrome control tower must be advised of an area or areas suitable for the parking of an aircraft which is known or believed to be the subject of unlawful interference, or which for other reasons needs isolation from normal Aerodrome activities.
- (b) The isolated aircraft position must be located at the maximum distance practicable and any case never less than 100 m from other parking positions, buildings, or public areas, etc. Care must be taken to ensure that the position is not located over underground utilities such as gas and aviation fuel and, to the extent feasible, electrical or communication cables.

### **§ 139.329 De-icing / Anti- icing facilities**

- (a) General

Aeroplane de-icing /anti-icing facilities must be provided at an aeroplane where icing conditions are expected to occur.

- (b) Location

- (1) De-icing/anti-icing facilities must be provided either at aircraft stands or at specific stands or at specified remote areas along the taxiway leading to the runway meant for take-off, provided that adequate drainage arrangements for the collection and safe disposal of excess de-icing/ anti-icing fluids are available to prevent ground water contamination. The effect of volume of traffic and departure flow rates must also be considered.
- (2) The remote de-icing/anti-icing facility must be located to be clear of the obstacle limitation surface specified in Subpart G, not cause interference to radio navigation aids and to be clearly visible from the air traffic control tower for clearing the treated aeroplane.
- (3) The remote de-icing/anti-icing facility must be so located as to provide for the expeditious traffic flow, perhaps with a bypass configuration, and not require unusual taxiing maneuvering into out of the pads.

- (c) Size and number of de-icing/anti-icing pads

---

## **GACAR PART 139 – CERTIFICATION, AUTHORIZATION AND OPERATION OF AERODROMES**

---

- (1) The size of a de-icing/ anti-icing pad must be equal to the parking area required by the most demanding aeroplane in a given category with at least 3.8 m clear paved area all around the aeroplane for the movement of the de-icing/ anti-icing vehicles.
- (2) The number of de-icing/anti-icing pads required must be determined based on the meteorological conditions, the type of aeroplane to be treated by the method of application of de-icing/anti-icing fluid, the type of capacity of the dispensing equipment used, and the departure flow rates.

(d) Slopes of de-icing/anti-icing pads

The de-icing/anti-icing pads must be provided with suitable slopes to ensure satisfactory drainage of the area and to permit collection of all excess de-icing/anti-icing fluid running off an aeroplane. The maximum longitudinal slopes must be as little as practicable, and the transverse slope must not exceed 1 per cent.

(e) Strength of the de-icing/anti-icing pads

The de-icing/anti-icing pad must be capable of withstanding the traffic of the aircraft is intended to serve, due consideration being given to the fact that the de-icing/anti-icing pad (like an apron) will be subjected to a higher density of traffic and, as a result of slow moving or stationary aircraft, to higher stresses than a runway.

(f) Clearance distances on a de-icing/anti-icing pad

- (1) A de-icing/anti-icing pad must provide the minimum clearances specified in § 139.325-(e) for aircraft stands. If the pad layout is such as to include bypass configuration, the minimum separation distances specified in Table F-1, column 13, must be provided.
- (2) Where the de-icing/anti-icing facility is located adjoining a regular taxiway, the taxiway minimum separation distance specified in Table F-1, column 11, must be provided (See Figure F-4).

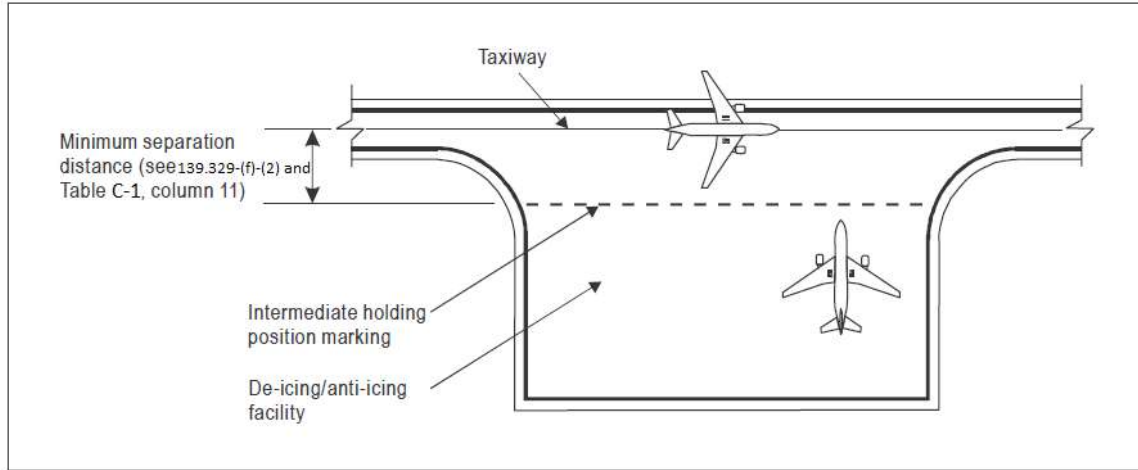
(g) Environmental considerations

Where de-icing/anti-icing activities are carried out, the surface drainage must be planned to collect the runoff separately, preventing its mixing with the normal surface run-off so that it does not pollute the ground water.

---

**GACAR PART 139 – CERTIFICATION, AUTHORIZATION AND OPERATION OF  
AERODROMES**

---



**Figure F-4. Minimum separation distance on a de-icing/anti-icing facility**

---

## GACAR PART 139 – CERTIFICATION, AUTHORIZATION AND OPERATION OF AERODROMES

---

### SUBPART G – OBSTACLE RESTRICTION AND REMOVAL

#### § 139.401 Obstacle Limitation Surfaces

See Figure G-1.

(a) Outer horizontal surface.

- (1) An outer horizontal surface is a specified portion of a horizontal plane around an Aerodrome beyond the limits of the conical surface. It represents the level above which consideration needs to be given to the control of new obstacles in order to facilitate practicable and efficient instrument approach procedures, and together with the conical and inner horizontal surfaces to ensure safe visual maneuvering in the vicinity of an Aerodrome.
- (2) An outer horizontal surface must be established for every Aerodrome where the runway code number 3 or 4.
- (3) The outer horizontal surface extends from the periphery of the conical surface to a minimum radius of 15000 m from the Aerodrome reference point. The area of concern may need to be extended to coincide with the PANS OPS obstacle areas for the individual approach procedures at the airport under consideration.
- (4) As a broad specification for the outer horizontal surface, tall structures can be considered to be of possible significance if they are both higher than 30 m above local ground level, and higher than 150 m above Aerodrome elevation.

*Note 1 - Guidance on the need to provide an outer horizontal surface and its characteristics is contained in the ICAO Airport Services Manual (Doc 9137), Part 6.*

*Note 2- For guidance only, Figure G-2 shows the relationship between the outer horizontal, the conical, the inner horizontal, and the transitional surfaces.*

(b) Conical surface

- (1) Description. - Conical surface. A surface sloping upwards and outwards from the periphery of the inner horizontal surface. It represents the level above which consideration needs to be given to the control of new obstructions and the removal or marking of existing obstructions so as to ensure safe visual maneuvering in the vicinity of an Aerodrome.
- (2) Characteristics. - The limits of the conical surface must comprise:

---

## GACAR PART 139 – CERTIFICATION, AUTHORIZATION AND OPERATION OF AERODROMES

---

- (i) A lower edge coincident with the periphery of the inner horizontal surface; and
  - (ii) An upper edge located at a specified height above the inner horizontal surface.
- (3) The slope of the conical surface must be measured in a vertical plane perpendicular to the periphery of the inner horizontal surface. The relevant height is specified in Table G-1.

*Note: For guidance only, see Figure G-2*

- (4) If an outer horizontal surface is present and the end of the conical surface does not terminate directly into the commencement of the outer horizontal surface, the conical surface must then continue outwards on the same plane perpendicular to the periphery of the inner horizontal surface until it reaches the commencement of the outer horizontal surface.
- (5) A conical surface must be established for every aerodrome.

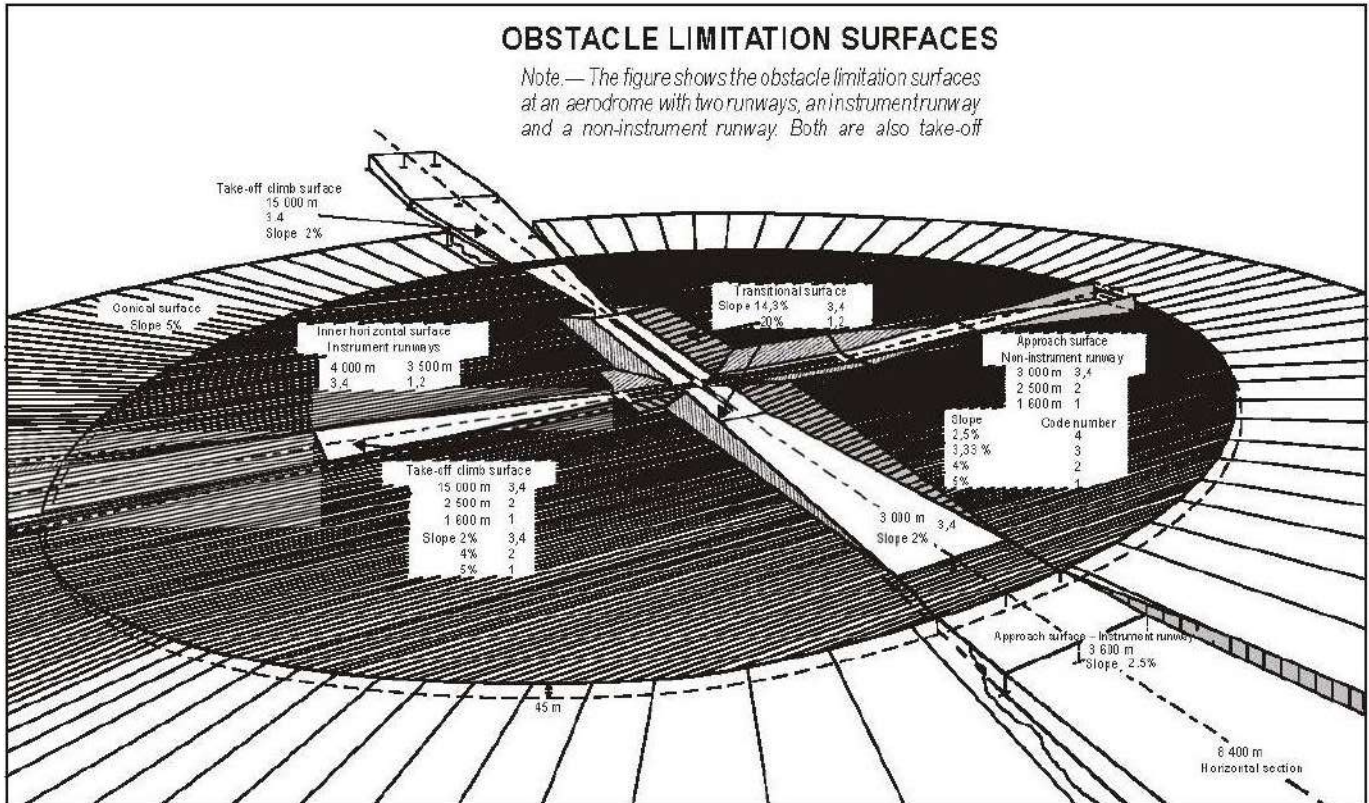
### (c) Inner horizontal surface

- (1) Description: inner horizontal surface. A surface located in a horizontal plane above an aerodrome and its environs.
- (2) An inner horizontal surface represents the level above which consideration needs to be given to the control of new obstacles and the removal or marking of existing obstacles to ensure safe visual maneuvering of aeroplane in the vicinity of the aerodrome.
- (3) An inner horizontal surface must be established for every aerodrome.
- (4) Where the inner horizontal surface is at any point lower than an approach surface or take-off climb surface, the inner horizontal surface is the obstacle limitation surface at that point.
- (5) Inner horizontal surface must be established for every aerodrome.
- (6) Characteristics. - The radius or outer limits of the inner horizontal surface must be measured from a reference point or points established for such purpose. The limits are established as follows:
  - (i) In the case of an aerodrome with a single runway, semi-circular curves of a specified radius measured from the runway threshold and joined tangentially by straight lines on each side of the runway, parallel to the runway centerline;
  - (ii) In the case of an aerodrome with multiple runways, curves of a specified radius measured from the runway threshold and the curves are joined by a tangential line as two curves intersect.

*Note: the value of radius is specified in Table G-1*

## GACAR PART 139 – CERTIFICATION, AUTHORIZATION AND OPERATION OF AERODROMES

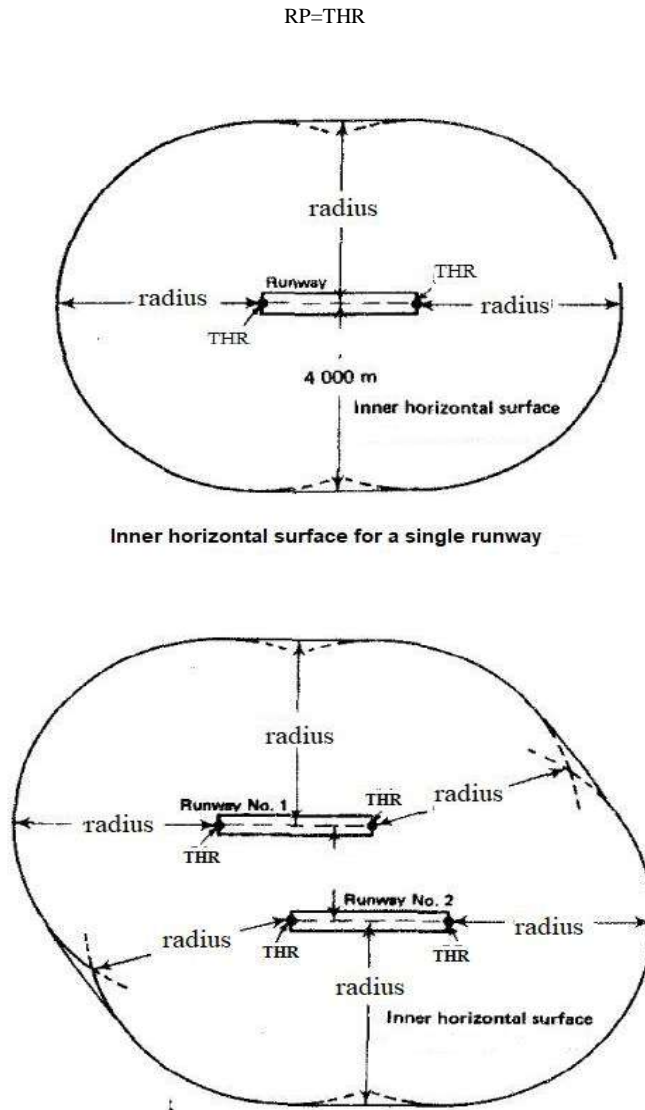
- (7) The height of the inner horizontal surface must be measured above an elevation datum established for such purpose. The height is 45 m above the elevation of the lowest runway threshold existing or proposed for the aerodrome.



**Figure G-1. Plan view of an obstacle limitation surface (OLS)**

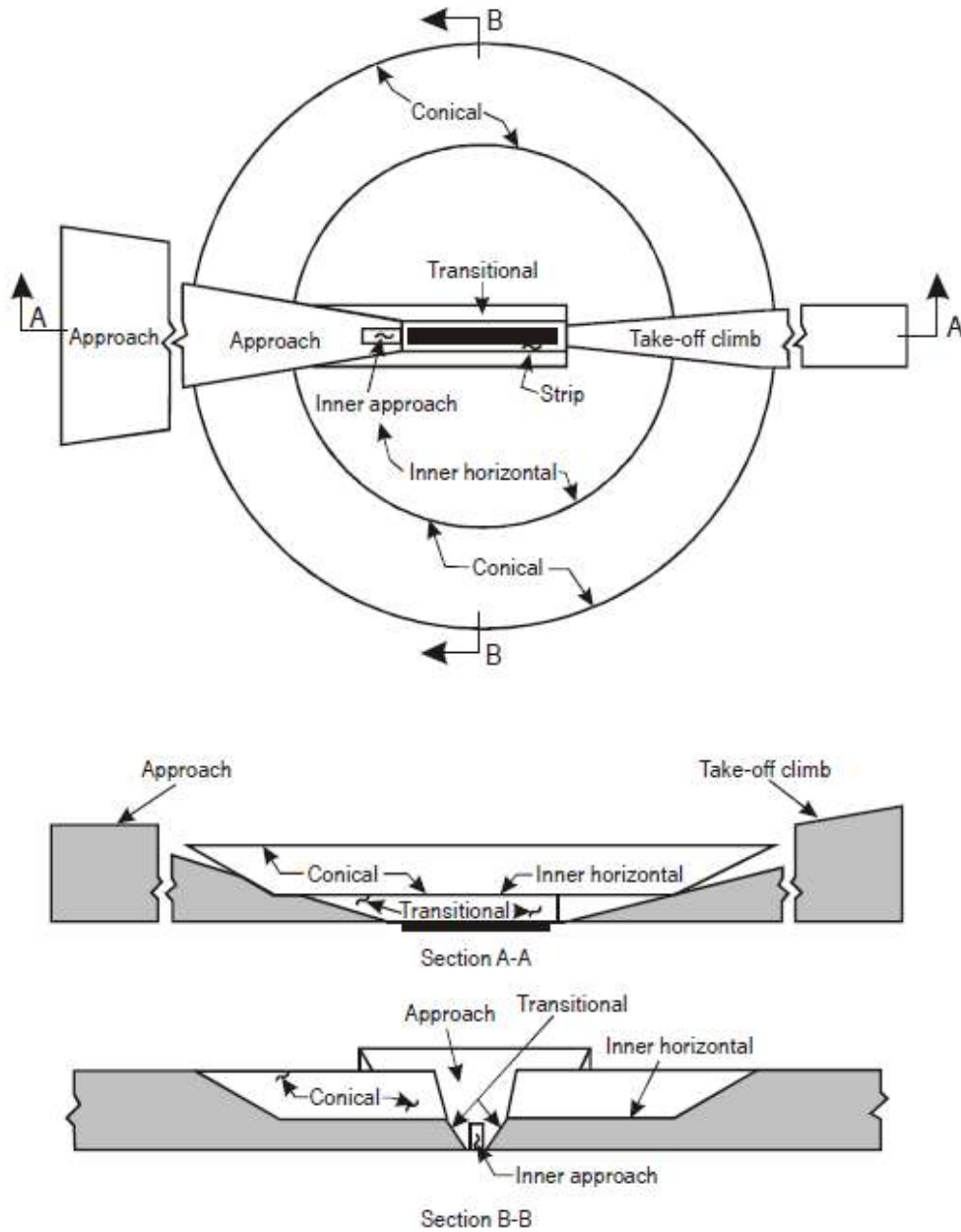


## GACAR PART 139 – CERTIFICATION, AUTHORIZATION AND OPERATION OF AERODROMES



**Figure G-2. Boundary of inner horizontal surface (illustrates matters)**

## GACAR PART 139 – CERTIFICATION, AUTHORIZATION AND OPERATION OF AERODROMES



*See Figure G-4 for inner transitional and balked landing obstacle limitation surfaces.*

**Figure G-3. Obstacle Limitation Surfaces.**

---

## GACAR PART 139 – CERTIFICATION, AUTHORIZATION AND OPERATION OF AERODROMES

---

### (d) Approach surface

- (1) Description: approach surface is an inclined plane or combination of planes preceding the threshold.

*Note- The purpose of the approach surface is to protect an aircraft during the final approach to the runway by defining the area that should be kept free from obstacles to protect an aeroplane in the final phase of the approach-to-land maneuver.*

- (2) Characteristics: the limits of the approach surface must comprise:

- (i) An inner edge of specified length, horizontal and perpendicular to the extended centerline of the runway and located at a specified distance before the threshold (dimensions are indicated in table D-1);
  - (ii) Two sides originating at the ends of the inner edge and diverging uniformly at a specified rate from the extended centerline of the runway (dimensions are in table D-1);
  - (iii) An outer edge parallel to the inner edge; and
  - (iv) The above surfaces must be varied when lateral offset, offset or curved approaches are utilized, specifically, two sides originating at the ends of the inner edge and diverging uniformly at a specified rate from the extended centerline of the lateral offset, offset or curved ground track.
- (3) The elevation of the inner edge must be equal to the elevation of the mid-point of the threshold.
  - (4) The approach surface may be divided into 3 sections and ends at an outer edge that is located at the relevant overall distance from the inner edge, and parallel to the inner edge, as specified in Table D-1.
  - (5) The slope(s) of the approach surface must be measured in the vertical plane containing the centerline of the runway and must continue containing the centerline of any lateral offset or curved ground track as specified in table D-1.
  - (6) Approach surface must be established for every aerodrome.

### (e) Inner approach surface

- (1) Description. - Inner approach surface. A rectangular portion of the approach surface immediately preceding the threshold.
- (2) Characteristics. - The limits of the inner approach surface must comprise:

---

## GACAR PART 139 – CERTIFICATION, AUTHORIZATION AND OPERATION OF AERODROMES

---

- (i) An inner edge coincident with the location of the inner edge of the approach surface but of its own specified length;
- (ii) Two sides originating at the ends of the inner edge and extending parallel to the vertical plane containing the center line of the runway; and
- (ii) An outer edge parallel to the inner edge.

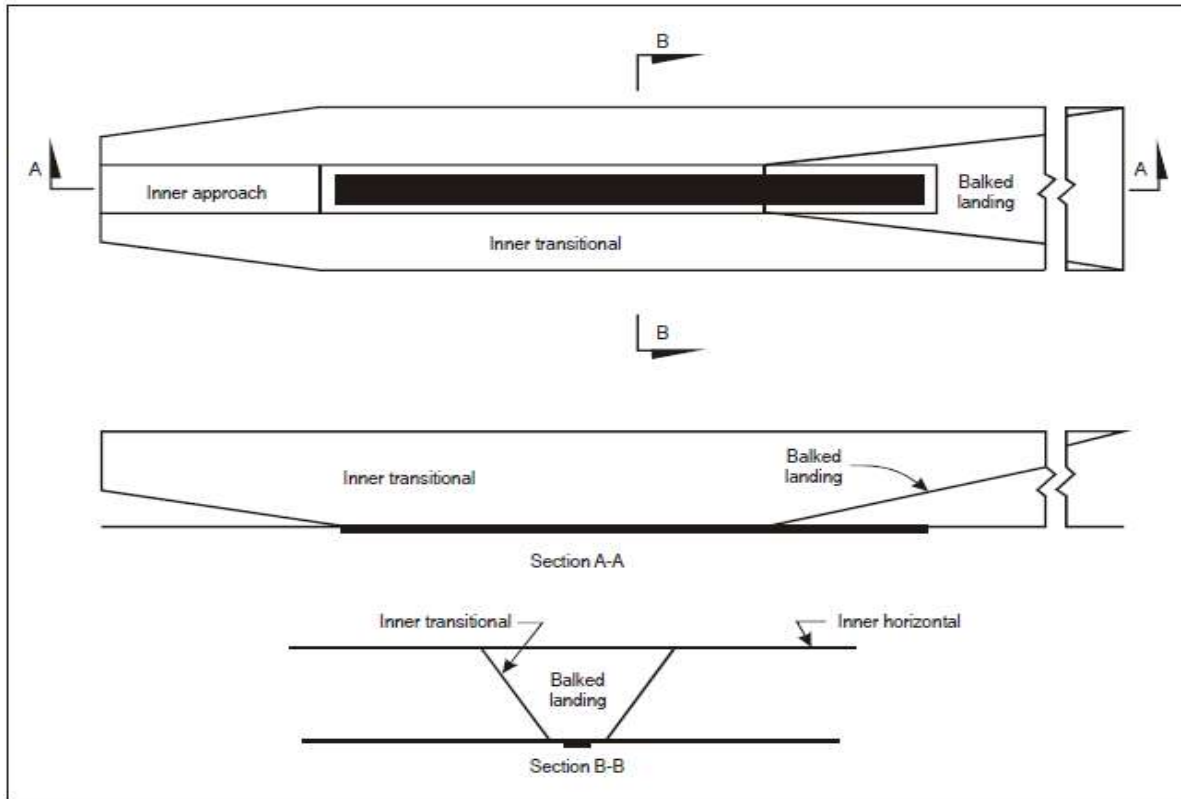
(f) Transitional surface

- (1) Description.  
Transitionnel surface. A complex surface along the side of the strip and part of the side of the approach surface, that slopes upwards and outwards to the inner horizontal surface.
- (2) Characteristics. - The limits of a transitional surface must comprise:
  - (i) A lower edge beginning at the intersection of the side of the approach surface with the inner horizontal surface and extending down the side of the approach surface to the inner edge of the approach surface and from there along the length of the strip parallel to the runway center line; and
  - (ii) An upper edge located in the plane of the inner horizontal surface.
- (3) The elevation of a point on the lower edge must be:
  - (i) Along the side of the approach surface — equal to the elevation of the approach surface at that point; and
  - (ii) Along the strip — equal to the elevation of the nearest point on the center line of the runway or its extension.

*Note - As a result of ii) the transitional surface along the strip will be curved if the runway profile is curved, or a plane if the runway profile is a straight line. The intersection of the transitional surface with the inner horizontal surface will also be a curved or a straight line depending on the runway profile.*

- (4) The slope of the transitional surface must be measured in a vertical plane at right angles to the centre line of the runway. Transitional surface must be established for every Aerodrome.
- (5) Transitional surface must be established for every aerodrome.

## GACAR PART 139 – CERTIFICATION, AUTHORIZATION AND OPERATION OF AERODROMES



**Figure G-4. Inner Approach, inner transitional and balked landing obstacle limitation surface. (Obstacle free Zone).**

(g) Inner transitional surface

It is intended that the inner transitional surface be the controlling obstacle limitation surface for navigation aids, aircraft and other vehicles that must be near the runway and which is not to be penetrated except for frangible objects. The transitional surface described in § 139.401- (f) - (1) is intended to remain as the controlling obstacle limitation surface for buildings, etc.

- (1) Description. - Inner transitional surface is a surface similar to the transitional surface but closer to the runway.
- (2) Characteristics. - The limits of an inner transitional surface must comprise:
  - (i) A lower edge beginning at the end of the inner approach surface and extending down the side of the inner approach surface to the inner edge of that surface, from there along the strip parallel to the runway center line to the inner edge of the balked

---

## GACAR PART 139 – CERTIFICATION, AUTHORIZATION AND OPERATION OF AERODROMES

---

- landing surface and from there up the side of the balked landing surface to the point where the side intersects the inner horizontal surface; and
- (ii) An upper edge located in the plane of the inner horizontal surface.
- (3) The elevation of a point on the lower edge must be:
- (i) Along the side of the inner approach surface and balked landing surface — equal to the elevation of the particular surface at that point; and
  - (ii) Along the strip — equal to the elevation of the nearest point on the center line of the runway or its extension.

*Note: As a result of ii) the inner transitional surface along the strip will be curved if the runway profile is curved or a plane if the runway profile is a straight line. The intersection of the inner transitional surface with the inner horizontal surface will also be a curved or straight line depending on the runway profile.*

- (4) The slope of the inner transitional surface must be measured in a vertical plane at right angles to the center line of the runway.

(h) Balked landing surface

- (1) Description. - Balked landing surface. An inclined plane located at a specified distance after the threshold, extending between the inner transitional surface.
- (2) Characteristics. - The limits of the balked landing surface must comprise:
  - (i) An inner edge horizontal and perpendicular to the center line of the runway and located at a specified distance after the threshold;
  - (ii) Two sides originating at the ends of the inner edge and diverging uniformly at a specified rate from the vertical plane containing the center line of the runway; and
  - (iii) An outer edge parallel to the inner edge and located in the plane of the inner horizontal surface.
- (3) The elevation of the inner edge must be equal to the elevation of the runway center line at the location of the inner edge.
- (4) The slope of the balked landing surface must be measured in the vertical plane containing the center line of the runway.

(i) Obstacle-free zone (OFZ)

Inner Approach, Inner Transitional and Balked Landing Surfaces together, define a volume of airspace in the immediate vicinity of a precision approach runway which is known as the obstacle-

---

## **GACAR PART 139 – CERTIFICATION, AUTHORIZATION AND OPERATION OF AERODROMES**

---

free zone (OFZ). This zone must be kept free from fixed objects, other than lightweight frangible mounted aids to air navigation which must be near the runway to perform their function, and from transient objects such as aircraft and vehicles when the runway is being used for category II or III ILS approaches.

Guidance on OFZ is contained in the ICAO Airport Services Manual (Doc 9137), Part 6.

(j) Take-off climb surface.

- (1) Description. - Take-off climb surface. An inclined plane or other specified surface beyond the end of a runway or clearway.
- (2) Characteristics. - The limits of the take-off climb surface must comprise:
  - (i) An inner edge horizontal and perpendicular to the center line of the runway and located either at a specified distance beyond the end of the runway or at the end of the clearway when such is provided, and its length exceeds the specified distance;
  - (ii) Two sides originating at the ends of the inner edge, diverging uniformly at a specified rate from the take-off track to a specified final width and continuing thereafter at that width for the remainder of the length of the takeoff climb surface; and
  - (iii) An outer edge horizontal and perpendicular to the specified take-off track.
- (3) The elevation of the inner edge must be equal to the highest point on the extended runway center line between the end of the runway and the inner edge, except that when a clearway is provided the elevation must be equal to the highest point on the ground on the center line of the clearway.
- (4) In the case of a straight take-off flight path, the slope of the take-off climb surface must be measured in the vertical plane containing the center line of the runway.
- (5) In the case of a take-off flight path involving a turn, the take-off climb surface must be a complex surface containing the horizontal normal to its center line, and the slope of the center line must be the same as that for a straight take-off flight path.

### **§ 139.403 Obstacle limitation requirements**

The requirements for obstacle limitation surfaces are specified on the basis of the intended use of a runway, i.e., take-off or landing and type of approach, and are intended to be applied when such use is made of the runway. In cases where operations are conducted to or from both directions of a runway, then the function of certain surfaces may be nullified because of more stringent requirements of another lower surface.

(a) Non-instrument runways

---

## GACAR PART 139 – CERTIFICATION, AUTHORIZATION AND OPERATION OF AERODROMES

---

- (1) The following obstacle limitation surfaces must be established for a non-instrument runway:
  - (i) Conical surface;
  - (ii) Inner horizontal surface;
  - (iii) Approach surface; and
  - (iv) Transitional surfaces.
- (2) The heights and slopes of the surfaces must not be greater than, and their other dimensions not less than, those specified in Table G-1.
- (3) New objects or extensions of existing objects must not be permitted above an approach or transitional surface except when, in the opinion of the President, the new object or extension would be shielded by an existing immovable object or after aeronautical study it is determined that the object would not adversely affect the safety or significantly affect the regularity of operations of aeroplanes.
- (4) New objects or extensions of existing objects must not be permitted above the conical surface or inner horizontal surface except when, in the opinion of the President, the object would be shielded by an existing immovable object, or after aeronautical study it is determined that the object would not adversely affect the safety or significantly affect the regularity of operations of aeroplanes.
- (5) Existing objects above any of the surfaces required by § 139.403-(a)-(1) must as far as practicable be removed except when, in the opinion of the President, the object is shielded by an existing immovable object, or after aeronautical-study it is determined that the object would not adversely affect the safety or significantly affect the regularity of operations of aeroplanes.

*Note. — Because of transverse or longitudinal slopes on a strip, in certain cases the inner edge or portions of the inner edge of the approach surface may be below the corresponding elevation of the strip. It is not intended that the strip be graded to conform with the inner edge of the approach surface, nor is it intended that terrain or objects which are above the approach surface beyond the end of the strip, but below the level of the strip, be removed unless it is considered they may endanger aeroplanes.*

- (6) In considering proposed construction, account must be taken of the possible future development of an instrument runway and consequent requirement for more stringent obstacle limitation surfaces.

(b) Non-precision approach runways



---

## **GACAR PART 139 – CERTIFICATION, AUTHORIZATION AND OPERATION OF AERODROMES**

---

- (1) The following obstacle limitation surfaces must be established for a non-precision approach runway:
  - (i) Conical surface;
  - (ii) Inner horizontal surface;
  - (iii) Approach surface; and
  - (iv) Transitional surfaces.
- (2) The heights and slopes of the surfaces must not be greater than, and their other dimensions not less than, those specified in Table G -1, except in the case of the horizontal section of the approach surface (see § 139.403-(b)-(3)).
- (3) The approach surface must be horizontal beyond the point at which the 2.5 per cent slope intersects:
  - (i) A horizontal plane 150 m above the threshold elevation; or
  - (ii) The horizontal plane passing through the top of any object that governs the obstacle clearance altitude/height (OCA/H); whichever is the higher.
- (4) New objects or extensions of existing objects must not be permitted above an approach surface within 3,000m of the inner edge or above a transitional surface except when, in the opinion of the President, the new object or extension would be shielded by an existing immovable object or after aeronautical study it is determined that the object would not adversely affect the safety or significantly affect the regularity of operations of aeroplanes.
- (5) New objects or extensions of existing objects must not be permitted above the approach surface beyond 3,000 m from the inner edge, the conical surface or inner horizontal surface except when, in the opinion of the President, the object would be shielded by an existing immovable object, or after aeronautical study it is determined that the object would not adversely affect the safety or significantly affect the regularity of operations of aeroplanes.
- (6) Existing objects above any of the surfaces required by § 139.403-(b)-(1) must as far as practicable be removed except when, in the opinion of the President, the object is shielded by an existing immovable object, or after aeronautical study it is determined that the object would not adversely affect the safety or significantly affect the regularity of operations of aeroplanes.

(c) Precision approach runways

See § 139.917 for information regarding siting of equipment and installations on operational areas.

---

## **GACAR PART 139 – CERTIFICATION, AUTHORIZATION AND OPERATION OF AERODROMES**

---

Guidance on obstacle limitation surfaces for precision approach runways is given in the ICAO Airport Services Manual (Doc 9137), Part 6.

- (1) The following obstacle limitation surfaces must be established for a precision approach runway category I:
  - (i) Conical surface;
  - (ii) Inner horizontal surface;
  - (iii) Approach surface; and
  - (iv) Transitional surfaces.
- (2) When requested by the President, the following obstacle limitation surfaces must be established for a precision approach runway category I :
  - (j) Inner approach surface;
  - (ii) Inner transitional surfaces; and
  - (iii) Balked landing surface.
- (3) The following obstacle limitation surfaces must be established for a precision approach runway category II or III:
  - (i) Conical surface;
  - (ii) Inner horizontal surface;
  - (iii) Approach surface and inner approach surface;
  - (iv) Transitional surfaces;
  - (v) Inner transitional surfaces; and
  - (vi) Balked landing surface.
- (4) The heights and slopes of the surfaces must not be greater than, and their other dimensions not less than, those specified in Table G-1, except in the case of the horizontal section of the approach surface (see § 139.403-(c)-(5)).
- (5) The approach surface must be horizontal beyond the point at which the 2.5 per cent slope intersects:
  - (i) A horizontal plane 150 m above the threshold elevation; or
  - (ii) The horizontal plane passing through the top of any object that governs the obstacle clearance limit; Whichever is the higher.

## GACAR PART 139 – CERTIFICATION, AUTHORIZATION AND OPERATION OF AERODROMES

### APPROACH RUNWAYS

| Surface and dimensions <sup>a</sup><br>(1) | RUNWAY CLASSIFICATION         |          |          |          |                                       |                      |                      |   |                      |                      |   |
|--|-------------------------------|----------|----------|----------|---------------------------------------|----------------------|----------------------|---|----------------------|----------------------|---|
|  | Non-instrument<br>Code number |          |          |          | Non-precision approach<br>Code number |                      |                      | Precision approach category<br>I<br>Code number |                      |                      | Precision approach category<br>II or III<br>Code number |
|  | 1<br>(2)                      | 2<br>(3) | 3<br>(4) | 4<br>(5) | 1,2<br>(6)                            | 3<br>(7)             | 4<br>(8)             | 1,2<br>(9)                                      | 3,4<br>(10)          | 3,4<br>(11)          |   |
| <b>CONICAL</b>                             |                               |          |          |          |                                       |                      |                      |   |                      |                      |   |
| Slope                                      | 5%                            | 5%       | 5%       | 5%       | 5%                                    | 5%                   | 5%                   | 5%  | 5%                   | 5%                   |   |
| Height                                     | 35 m                          | 55 m     | 75 m     | 100 m    | 60 m                                  | 75 m                 | 100 m                | 60 m  | 100 m                | 100 m                |   |
| <b>INNER HORIZONTAL</b>                    |                               |          |          |          |                                       |                      |                      |   |                      |                      |   |
| Height                                     | 45 m                          | 45 m     | 45 m     | 45 m     | 45 m                                  | 45 m                 | 45 m                 | 45 m  | 45 m                 | 45 m                 |   |
| Radius                                     | 2 000 m                       | 2 500 m  | 4 000 m  | 4 000 m  | 3 500 m                               | 4 000 m              | 4 000 m              | 3 500 m   | 4 000 m              | 4 000 m              |   |
| <b>INNER APPROACH</b>                      |                               |          |          |          |                                       |                      |                      |   |                      |                      |   |
| Width                                      | —                             | —        | —        | —        | —                                     | —                    | —                    | 90 m  | 120 m <sup>e</sup>   | 120 m <sup>e</sup>   |   |
| Distance from threshold                    | —                             | —        | —        | —        | —                                     | —                    | —                    | 60 m  | 60 m                 | 60 m                 |   |
| Length                                     | —                             | —        | —        | —        | —                                     | —                    | —                    | 900 m   | 900 m                | 900 m                |   |
| Slope                                      | —                             | —        | —        | —        | —                                     | —                    | —                    | 2.5%  | 2%                   | 2%                   |   |
| <b>APPROACH</b>                            |                               |          |          |          |                                       |                      |                      |   |                      |                      |   |
| Length of inner edge                       | 60 m                          | 80 m     | 150 m    | 150 m    | 140 m                                 | 280 m                | 280 m                | 140 m   | 280 m                | 280 m                |   |
| Distance from threshold                    | 30 m                          | 60 m     | 60 m     | 60 m     | 60 m                                  | 60 m                 | 60 m                 | 60 m  | 60 m                 | 60 m                 |   |
| Divergence (each side)                     | 10%                           | 10%      | 10%      | 10%      | 15%                                   | 15%                  | 15%                  | 15%   | 15%                  | 15%                  |   |
| <b>First section</b>                       |                               |          |          |          |                                       |                      |                      |   |                      |                      |   |
| Length                                     | 1 600 m                       | 2 500 m  | 3 000 m  | 3 000 m  | 2 500 m                               | 3 000 m              | 3 000 m              | 3 000 m   | 3 000 m              | 3 000 m              |   |
| Slope                                      | 5%                            | 4%       | 3.33%    | 2.5%     | 3.33%                                 | 2%                   | 2%                   | 2.5%  | 2%                   | 2%                   |   |
| <b>Second section</b>                      |                               |          |          |          |                                       |                      |                      |   |                      |                      |   |
| Length                                     | —                             | —        | —        | —        | —                                     | 3 600 m <sup>b</sup> | 3 600 m <sup>b</sup> | 12 000 m  | 3 600 m <sup>b</sup> | 3 600 m <sup>b</sup> |   |
| Slope                                      | —                             | —        | —        | —        | —                                     | 2.5%                 | 2.5%                 | 3%  | 2.5%                 | 2.5%                 |   |
| <b>Horizontal section</b>                  |                               |          |          |          |                                       |                      |                      |   |                      |                      |   |
| Length                                     | —                             | —        | —        | —        | —                                     | 8 400 m <sup>b</sup> | 8 400 m <sup>b</sup> | —   | 8 400 m <sup>b</sup> | 8 400 m <sup>b</sup> |   |
| Total length                               | —                             | —        | —        | —        | —                                     | 15 000 m             | 15 000 m             | 15 000 m  | 15 000 m             | 15 000 m             |   |
| <b>TRANSITIONAL</b>                        |                               |          |          |          |                                       |                      |                      |   |                      |                      |   |
| Slope                                      | 20%                           | 20%      | 14.3%    | 14.3%    | 20%                                   | 14.3%                | 14.3%                | 14.3%   | 14.3%                | 14.3%                |   |
| <b>INNER TRANSITIONAL</b>                  |                               |          |          |          |                                       |                      |                      |   |                      |                      |   |
| Slope                                      | —                             | —        | —        | —        | —                                     | —                    | —                    | 40%   | 33.3%                | 33.3%                |   |
| <b>BALKED LANDING SURFACE</b>              |                               |          |          |          |                                       |                      |                      |   |                      |                      |   |
| Length of inner edge                       | —                             | —        | —        | —        | —                                     | —                    | —                    | 90 m  | 120 m <sup>e</sup>   | 120 m <sup>e</sup>   |   |
| Distance from threshold                    | —                             | —        | —        | —        | —                                     | —                    | —                    | 10%   | 1 800 m <sup>d</sup> | 1 800 m <sup>d</sup> |   |
| Divergence (each side)                     | —                             | —        | —        | —        | —                                     | —                    | —                    | 10%   | 10%                  | 10%                  |   |
| Slope                                      | —                             | —        | —        | —        | —                                     | —                    | —                    | 4%  | 3.33%                | 3.33%                |   |

a. All dimensions are measured horizontally unless specified otherwise.  
b. Variable length (§ 139.403-(b)-(3) or § 139.403-(c)-(5)).  
c. Distance to the end of strip.  
d. Or end of runway whichever is less.  
e. Where the code letter is F (Table A-1), the width is increased to 140 m except for those aerodromes that accommodate a code letter F aeroplanes equipped with digital avionics that provide steering commands to maintain an established track during the go-around manoeuvre.

**Table G-5. Dimensions and slopes of obstacle limitation surfaces – Approach runways.**

- (6) Fixed objects must not be permitted above the inner approach surface, the inner transitional surface or the balked landing surface, except for frangible objects which

---

## **GACAR PART 139 – CERTIFICATION, AUTHORIZATION AND OPERATION OF AERODROMES**

---

- because of their function must be located on the strip. Mobile objects must not be permitted above these surfaces during the use of the runway for landing.
- (7) New objects or extensions of existing objects must not be permitted above an approach surface or a transitional surface except when, in the opinion of the President, the new object or extension would be shielded by an existing immovable object or after aeronautical study it is determined that the object would not adversely affect the safety or significantly affect the regularity of operations of aeroplanes.
  - (8) New objects or extensions of existing objects must not be permitted above the conical surface and the inner horizontal surface except when, in the opinion of the President, an object would be shielded by an existing immovable object, or after aeronautical study it is determined that the object would not adversely affect the safety or significantly affect the regularity of operations of aeroplanes.
  - (9) Existing objects above an approach surface, a transitional surface, the conical surface and inner horizontal surface must as far as practicable be removed except when, in the opinion of the GACA, an object is shielded by an existing immovable object, or after aeronautical study it is determined that the object would not adversely affect the safety or significantly affect the regularity of operations of aeroplanes.

(d) Runways meant for take-off

- (1) The following obstacle limitation surface must be established for a runway meant for take-off:
  - (i) take-off climb surface.
- (2) The dimensions of the surface must be not less than the dimensions specified in Table G-2, except that a lesser length may be adopted for the take-off climb surface where such lesser length would be consistent with procedural measures adopted to govern the outward flight of aeroplanes.
- (3) The operational characteristics of aeroplanes for which the runway is intended must be examined to see if it is desirable to reduce the slope specified in Table G-2 when critical operating conditions are to be catered to. If the specified slope is reduced, corresponding adjustment in the length of take-off climb surface must be made so as to provide protection to a height of 300 m.

## GACAR PART 139 – CERTIFICATION, AUTHORIZATION AND OPERATION OF AERODROMES

### RUNWAYS MEANT FOR TAKE-OFF

| Surface and dimensions*<br>(1)        | Code number |          |                                 |
|---------------------------------------|-------------|----------|---------------------------------|
|                                       | 1<br>(2)    | 2<br>(3) | 3 or 4<br>(4)                   |
| <b>TAKE-OFF CLIMB</b>                 |             |          |                                 |
| Length of inner edge                  | 60 m        | 80 m     | 180 m                           |
| Distance from runway end <sup>b</sup> | 30 m        | 60 m     | 60 m                            |
| Divergence (each side)                | 10%         | 10%      | 12.5%                           |
| Final width                           | 380 m       | 580 m    | 1 200 m<br>1 800 m <sup>c</sup> |
| Length                                | 1 600 m     | 2 500 m  | 15 000 m                        |
| Slope                                 | 5%          | 4%       | 2% <sup>d</sup>                 |

**Table G-6. Dimensions and slopes of obstacles limitation surfaces.**

- (i) All dimensions are measured horizontally unless specified otherwise.
  - (ii) The take-off climb surface starts at the end of the clearway if the clearway length exceeds the specified distance.
  - (iii) 1800m when the intended track includes of heading greater than 15° for operations conducted in IMC, VMC by night.
  - (iv) See § 139.403-(d)-(3) and § 139.403-(d)-(5).
- (4) New objects or extensions of existing objects must not be permitted above a take-off climb surface except when, in the opinion of the President, the new object or extension would be shielded by an existing immovable object or after aeronautical study it is determined that the object would not adversely affect the safety or significantly affect the regularity of operations of aeroplanes.
  - (5) If no object reaches the 2 per cent (1:50) take-off climb surface, new objects must be limited to preserve the existing obstacle free surface or a surface down to a slope of 1.6 per cent (1:62.5).
  - (6) Existing objects that extend above a take-off climb surface must as far as practicable be removed except when, in the opinion of the President, an object is shielded by an existing immovable object, or after aeronautical study it is determined that the object

---

## **GACAR PART 139 – CERTIFICATION, AUTHORIZATION AND OPERATION OF AERODROMES**

---

would not adversely affect the safety or significantly affect the regularity of operations of aeroplanes.

### **§ 139.405 Objects outside the obstacle limitation surfaces**

- (a) Arrangements must be made to enable the President to be consulted concerning proposed construction beyond the limits of the obstacle limitation surfaces that extend above a height established by that authority, in order to permit an aeronautical study of the effect of such construction on the operation of aeroplanes.
- (b) In areas beyond the limits of the obstacle limitation surfaces, at least those objects which extend to a height of 150 m or more above ground elevation must be regarded as obstacles, unless a special aeronautical study indicates that they do not constitute a hazard to aeroplanes.

*Note - Circumstances in which the aeronautical study may reasonably be applied are described in GACAR part 77.*

### **§ 139.407 Other objects**

- (a) Objects which do not project through the approach surface, but which would nevertheless adversely affect the optimum siting or performance of visual or non-visual aids must, as far as practicable, be removed.
- (b) Anything which may, in the opinion of the President after aeronautical study, endanger aeroplanes on the movement area or in the air within the limits of the inner horizontal and conical surfaces must be regarded as an obstacle and must be removed in so far as practicable.

*Note - Circumstances in which the aeronautical study may reasonably be applied are described in GACAR part 77.*

### **§ 139.409 Overlapping of OLS surfaces**

Where 2 OLS overlap, the lower surface must be used as the controlling obstacle limitation surface.

### **§ 139.411 Restriction and removal of obstacles**

- (a) Except as provided in § 139.403-(a)-(3), (4), (5), § 139.403-(b)-(4), (5), (6), § 139.403-(c)-(6), (7), (8), (9) and § 139.403-(d)-(4), (5)
- (b) Objects which do not penetrate an approach surface to a new runway or a proposed runway extension but, in the opinion of the President, which would nevertheless adversely affect the optimum performance of visual or non-visual aids must be removed.

---

## **GACAR PART 139 – CERTIFICATION, AUTHORIZATION AND OPERATION OF AERODROMES**

---

- (c) Anything which may, in the opinion of the President, endanger aircraft on the movement area must be removed. Except for those objects or vehicles on essential Aerodrome duties which, because of their function, must be positioned within the runway strip (but outside the cleared and graded area) to meet air navigation requirements, any object or vehicle situated on a runway strip which may endanger aircraft must be removed.
- (d) No object, whether fixed or mobile, is to be permitted to penetrate the balked landing surface of an OFZ established for Category II or III operations. Where this surface intercepts the Basic ILS missed approach obstacle clearance surface, the latter becomes limiting. The Basic ILS missed approach surface is a 2.5% (1:40) slope commencing 900 m after the landing threshold, at the same elevation as the threshold.
- (e) Confirmation that the extended OFZ balked landing surface is obstacle free up to the height where it intersects with the Category I ILS missed approach surface will normally be necessary only when the OFZ is initially established. Thereafter, the normal safeguarding procedures, as well as observance of the conditions of the aerodrome certification, will ensure that either the extended OFZ missed approach surface will remain obstacle free or that proposed constructions which might infringe the surface are referred to the President for consideration.
- (f) All roads and highways are considered to be obstacles extending to 4.8 m above the crown of the road. Similarly, railways, regardless of the amount of traffic, are considered to be obstacles extending 5.4 m above the top of the rails. On receipt of an acceptable safety assessment that considers the maximum possible height of the obstacle and has assessed, as far as practicable, future development of the surrounding infrastructure, the President may use its discretion in accepting lower values for mobile and fixed obstacles.
- (g) Because of the difficulty of recognition, special restrictions must be applied to elevated wires and their supports. Where no other object penetrates a given obstacle limitation surface, overhead wires and their supports should not penetrate a surface passing through the top of the highest existing object and parallel to the established surface for a distance of 1500 m from the runway threshold. The shielding criteria do not apply to the shielding of overhead wires.
- (h) Where there are transverse or longitudinal slopes on a strip or clearway the inner edge of a take-off climb surface, or an approach surface may lie partly or wholly below the level of the ground in the strip or clearway. It is not necessary that the strip or clearway should, in such cases, be graded to conform with the inner edge of the take-off climb or approach surface.

Circumstances in which the shielding principle and an aeronautical study may reasonably be applied are described in GACAR Part 77.

### **§ 139.413 Procedures for aerodrome operators to deal with obstacles in the OLS**

- (a) An aerodrome operator must:

---

## **GACAR PART 139 – CERTIFICATION, AUTHORIZATION AND OPERATION OF AERODROMES**

---

- (1) monitor the OLS for the aerodrome; and
  - (2) report to the President, in writing, any infringement, or potential infringement, of the OLS.
- (b) When a new obstacle is detected, the aerodrome operator must ensure that the information is passed on to pilots, through NOTAM, in accordance with the standards for aerodrome reporting procedures detailed in the aerodrome manual. The information on any new obstacle must include:
- (1) The nature of the obstacle; for instance, structure or machinery.
  - (2) The geographic coordinates in WGS-84 (degrees, minutes, seconds, and hundreds of seconds)
  - (3) Elevation (Mean Sea Level) and height of the obstacle in relation to the aerodrome elevation;
  - (4) If the obstacle is marked / lighted; and
  - (5) If it is a temporary obstacle; the time it is an obstacle.

### **§ 139.415 Objects or structures that could become obstacles in the OLS**

- (a) If a proposed object or structure is identified as likely to be an obstacle, details of the relevant proposal must be referred to the President to determine, in writing:
- (1) Whether the object or structure will be a hazard to aircraft operations; and
  - (2) Whether it requires an obstacle light that is essential for the safety of aircraft operations.
- (b) A runway must not be made available for night use for the first time until:
- (1) The Aerodrome operator has informed the President about obstacles within the OLS; and
  - (2) The President has determined that the obstacles will not adversely affect the safety of night operations.
- (c) A temporary or transient obstacle in close proximity to an Aerodrome and that infringes the OLS must be referred to the President to determine whether the obstacle will be a hazard to aircraft operations.

*Note: Transient obstacles would include, for example, road vehicles, rail carriages and ships.*

- (d) A fence or levee bank that infringes the OLS must be treated as an obstacle.
- (e) Referrals or information to the President must be made by the aerodrome operator in writing. Determinations concerning any objects or structures that could become obstacles in the OLS by the President must be in writing.
- (f) Procedures of information to the President on objects or structures that could become obstacles in the OLS must be included in the aerodrome manual.



---

## **GACAR PART 139 – CERTIFICATION, AUTHORIZATION AND OPERATION OF AERODROMES**

---

### **§ 139.417 Notes of construction or alteration**

Guidance on form and time of notice of proposed construction or alteration are specified in GACAR Part 77.

### **§ 139.419 Monitoring of obstacles associated with instrument runways**

- (a) An aerodrome operator must monitor any object or structure that may infringe the aerodrome's OLS and PANS-OPS airspace associated with instrument approach procedures.
- (b) Under regulation GACAR Part 172, instrument approach procedure designers provide aerodrome operators with information and drawings of the area around the aerodrome, showing the designed approach paths, the circling areas and locations of critical obstacles taken into account in the design.
- (c) An aerodrome operator must:
  - (1) Establish procedures to monitor:
    - (i) the OLS; and
    - (ii) such obstacles, associated with the aerodrome's terminal instrument flight procedures, as are determined by the instrument flight procedure designer to be critical obstacles; and
  - (2) Include the procedures in the aerodrome manual.
- (d) The aerodrome operator must inform the designer of a terminal instrument flight procedure at the aerodrome of the following:
  - (1) Any change in the status of an existing critical obstacle;
  - (2) Any proposed development that is to be higher than the critical obstacles within the area depicted by the designer;
  - (3) Any new object or structure that is higher than the critical obstacles within the area depicted by the designer.

### **§ 139.421 Training**

The aerodrome operator must designate a qualified officer to achieve obstacle control mission. This officer must receive specific training on the obstacle limitation surfaces and he must have the ability to use the necessary equipment to accomplish his mission.

### **§ 139.423 Aerodrome obstacle and terrain charts**

Guidance on the need to provide aerodrome obstacle and terrain charts and its characteristics is contained in GACAR Part 139 Subpart E.

**GACAR PART 139 – CERTIFICATION, AUTHORIZATION AND OPERATION OF  
AERODROMES**

---

**§ 139.425 Obstacle Survey**

The aerodrome operator will apply the aerodrome survey requirements as per AC 175-003.

---

## **GACAR PART 139 – CERTIFICATION, AUTHORIZATION AND OPERATION OF AERODROMES**

---

### **SUBPART H – VISUAL AIDS FOR NAVIGATION**

#### **§ 139.501 Indicators and signalling devices**

(a) Wind direction indicators

(1) Application

An aerodrome must be equipped with at least one wind direction indicator.

(2) Location

A wind direction indicator must be located so as to be visible from aircraft in flight or on the movement area and in such a way as to be free from the effects of air disturbances caused by nearby objects.

(3) Characteristics

- (i) The wind direction indicator must be in the form of a truncated cone made of fabric and must have a length of not less than 3.6 m and a diameter, at the larger end, of not less than 0.9 m. It must be constructed so that it gives a clear indication of the direction of the surface wind and a general indication of the wind speed. The color or colors must be so selected as to make the wind direction indicator clearly visible and understandable from a height of at least 300 m, having regard to background. Where practicable, a single color, preferably white or orange, must be used. Where a combination of two colors is required to give adequate conspicuity against changing backgrounds, they must preferably be orange and white, red and white, or black and white, and must be arranged in five alternate bands, the first and last bands being the darker color.
- (ii) The location of at least one wind direction indicator must be marked by a circular band 15 m in diameter and 1.2 m wide. The band must be centred about the wind direction indicator support and must be in a color chosen to give adequate conspicuity, preferably white.
- (iii) Provision must be made for illuminating at least one wind indicator at an Aerodrome intended for use at night.

(b) Landing direction indicator

---

## GACAR PART 139 – CERTIFICATION, AUTHORIZATION AND OPERATION OF AERODROMES

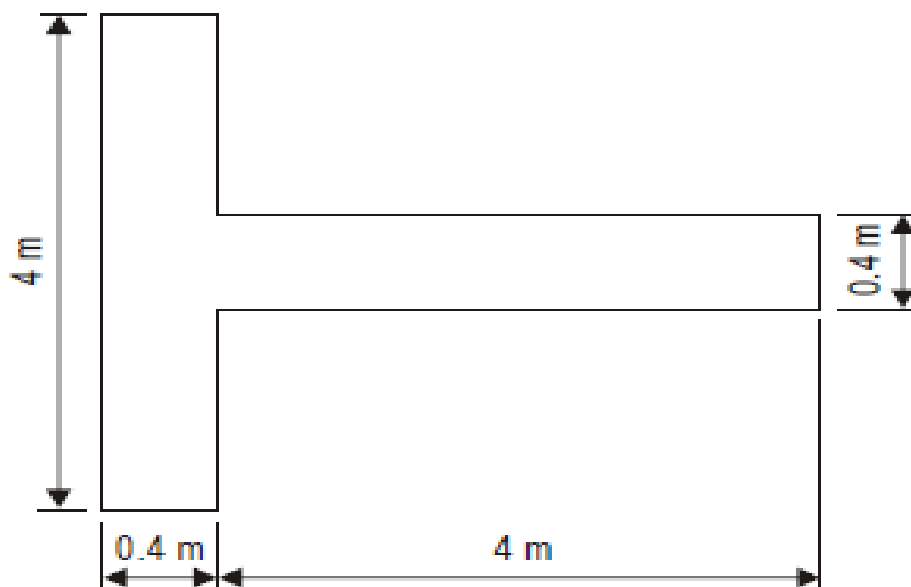
---

(1) Location

Where provided, a landing direction indicator must be located in a conspicuous place on the Aerodrome.

(2) Characteristics

- (i) The landing direction indicator must be in the form of a “T”.
- (ii) The shape and minimum dimensions of a landing “T” must be as shown in Figure H-1. The color of the landing “T” must be either white or orange, the choice being dependent on the color that contrasts best with the background against which the indicator will be viewed. Where required for use at night the landing “T” must either be illuminated or outlined by white lights.



**Figure H-1. Landing Direction Indicator**

(c) Signalling lamp

- (1) Application  
A signalling lamp must be provided at a controlled aerodrome in the aerodrome control tower.
- (2) Characteristics

---

## **GACAR PART 139 – CERTIFICATION, AUTHORIZATION AND OPERATION OF AERODROMES**

---

- (i) A signalling lamp must be capable of producing red, green and white signals, and of:
    - (A) Being aimed manually at any target as required;
    - (B) Giving a signal in any one color followed by a signal in either of the two other colors; and
    - (C) Transmitting a message in any one of the three colors by Morse Code up to a speed of at least four words per minute.  
When selecting the green light, use must be made of the restricted boundary of green as specified in Appendix H-II-(a) - (2).
  - (ii) The beam spread must be not less than 1° or greater than 3°, with negligible light beyond 3°. When the signalling lamp is intended for use in the daytime the intensity of the colored light must be not less than 6,000 cd.
- (d) Signal panels and signal area
- (1) Location of signal area  
  
The signal area must be located so as to be visible for all angles of azimuth above an angle of 10° above the horizontal when viewed from a height of 300m.
  - (2) Characteristics of signal area
    - (i) The signal area must be an even horizontal surface at least 9m square.
    - (ii) The color of the signal area must be chosen to contrast with the colors of the signal panels used, and it must be surrounded by a white border not less than 0.3m wide.

### **§ 139.503 Markings**

(a) General

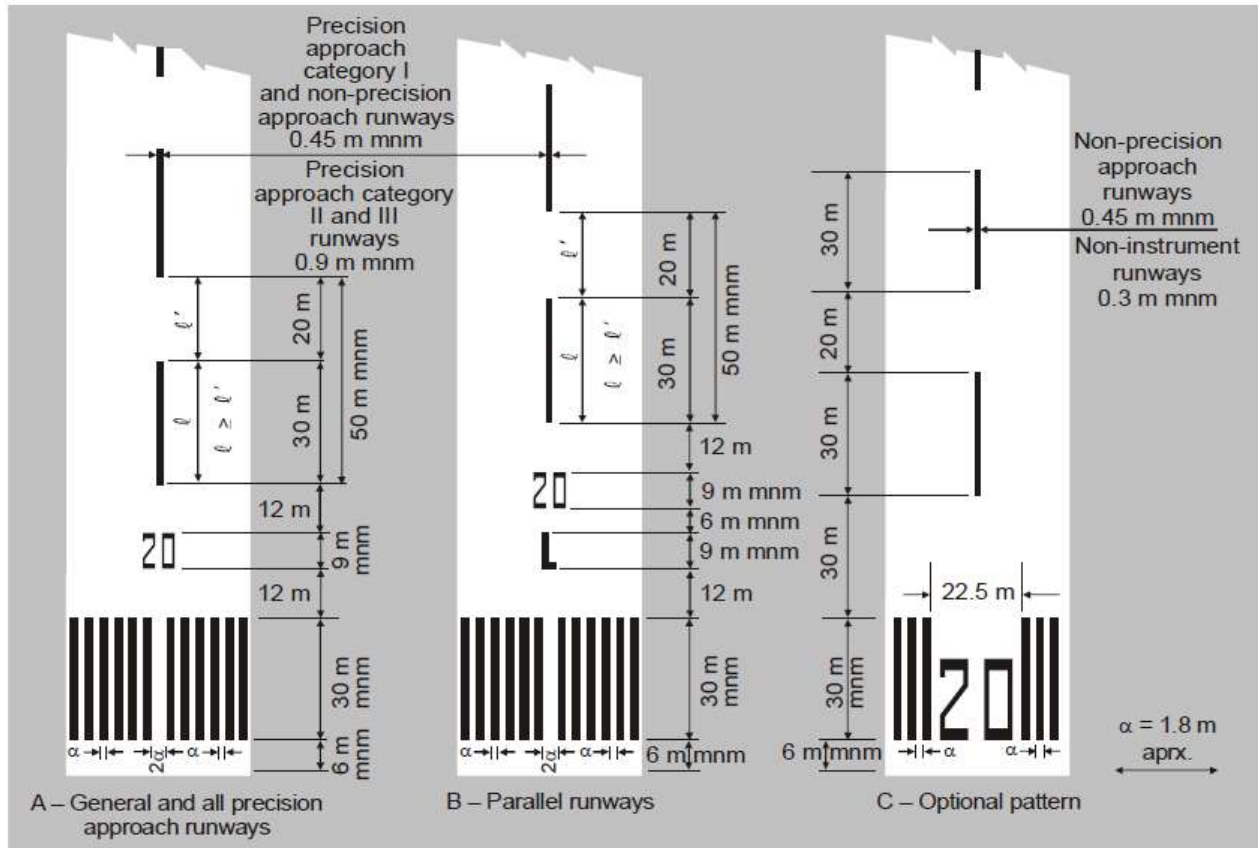
(1) Interruption of runway markings

- (i) At an intersection of two (or more) runways the markings of the more important runway, except for the runway side stripe marking, must be displayed and the markings of the other runway(s) must be interrupted. The runway side stripe marking of the more important runway may be either continued across the intersection or interrupted.
- (ii) The order of importance of runways for the display of runway markings must be as follows:
  - (A) 1<sup>st</sup> - Precision approach runway;

## **GACAR PART 139 – CERTIFICATION, AUTHORIZATION AND OPERATION OF AERODROMES**

- 
- (B) 2<sup>nd</sup> - Non-precision approach runway; and
  - (C) 3<sup>rd</sup> — Non-instrument runway
  - (iii) At an intersection of a runway and taxiway the markings of the runway must be displayed, and the markings of the taxiway interrupted, except that runway side stripe markings may be interrupted.
- (2) Color and conspicuity
- (i) Runway markings must be white.
  - (ii) Taxiway markings, runway turn pad marking and aircraft stand markings must be yellow.
  - (iii) Apron safety lines must be of a conspicuous color which must contrast with that used for aircraft stand markings.
  - (iv) At Aerodromes where operations take place at night, pavement markings must be made with reflective materials designed to enhance the visibility of the markings.
- (b) Runway designation marking
- (1) Application  
A runway designation marking must be provided at the thresholds of a paved runway.
  - (2) Location  
A runway designation marking must be located at a threshold as shown in Figure H-2 as appropriate.

## GACAR PART 139 – CERTIFICATION, AUTHORIZATION AND OPERATION OF AERODROMES



**Figure H-2. Runway Designation, Centre line and threshold marking.**

### (3) Characteristics

- (i) A runway designation marking must consist of a two-digit number and on parallel runways must be supplemented with a letter. On a single runway, dual parallel runways and triple parallel runways the two-digit number must be the whole number nearest the one-tenth of the magnetic North when viewed from the direction of approach. On four or more parallel runways, one set of adjacent runways must be numbered to the nearest one-tenth magnetic azimuth and the other set of adjacent runways numbered to the next nearest one-tenth of the magnetic azimuth. When the above rule would give a single digit number, it must be preceded by a zero.

---

## **GACAR PART 139 – CERTIFICATION, AUTHORIZATION AND OPERATION OF AERODROMES**

---

- (ii) In the case of parallel runways, each runway designation number must be supplemented by a letter as follows, in the order shown from left to right when viewed from the direction of approach:
  - (A) For two parallel runways: “L” “R”;
  - (B) For three parallel runways: “L” “C” “R”;
  - (C) For four parallel runways: “L” “R” “L” “R”;
  - (D) For five parallel runways: “L” “C” “R” “L” “R” or “L” “R” “L” “C” “R”; and
  - (E) For six parallel runways: “L” “C” “R” “L” “C” “R”.
- (iii) The numbers and letters must be in the form and proportion shown in Figure H-3. The dimensions must be not less than those shown in Figure H-3, but where the numbers are incorporated in the threshold marking, larger dimensions must be used in order to fill adequately the gap between the stripes of the threshold marking.

### (c) Runway centre line marking

#### (1) Application

A runway centre line marking must be provided on a paved runway.

#### (2) Location

A runway centre line marking must be located along the centre line of the runway between the runway designation markings as shown in Figure H-2, except when interrupted in compliance with § 139.503-(a)-(1).

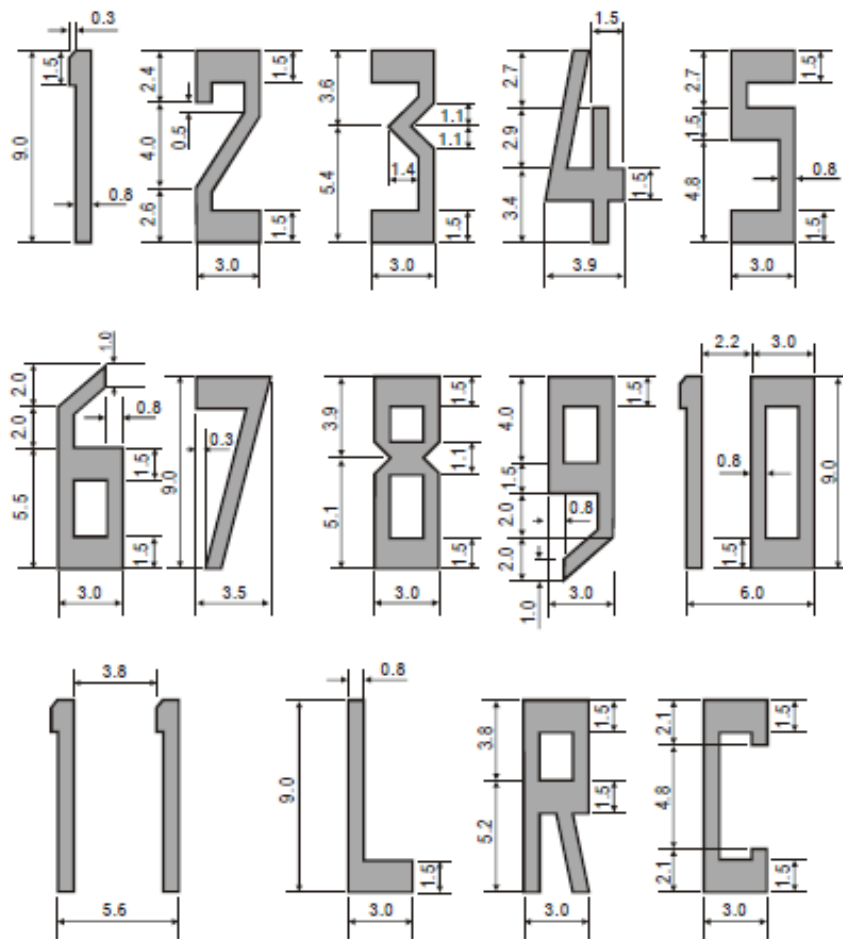
#### (3) Characteristics

- (i) A runway centre line marking must consist of a line of uniformly spaced stripes and gaps. The length of a stripe plus a gap must be not less than 50 m or more than 75 m. The length of each stripe must be at least equal to the length of the gap or 30 m, whichever is greater.
- (ii) The width of the stripes must be not less than:
  - (A) 0.90 m on precision approach category II and III runways;



## GACAR PART 139 – CERTIFICATION, AUTHORIZATION AND OPERATION OF AERODROMES

- (B) 0.45 m on non-precision approach runways where the code number is 3 or 4, and precision approach category I runways; and
- (C) 0.30 m on non-precision approach runways where the code number is 1 or 2, and on non-instrument runways.



*Note.— All units are expressed in metres.*

**Figure H-3. Form and proportions of numbers and letters for runway designation markings**

## GACAR PART 139 – CERTIFICATION, AUTHORIZATION AND OPERATION OF AERODROMES

### (d) Threshold marking

#### (1) Application

- (i) A threshold marking must be provided at the threshold of a paved instrument runway, and of a paved non instrument runway where the code number is 3 or 4 and the runway is intended for use by international commercial air transport.
- (ii) A threshold marking must be provided at the threshold of a paved non-instrument runway where the code number is 3 or 4 and the runway is intended for use by other than international commercial air transport.

#### (2) Location

The stripes of the threshold marking must commence 6 m from the threshold.

#### (3) Characteristics

- (i) A runway threshold marking must consist of a pattern of longitudinal stripes of uniform dimensions disposed symmetrically about the centre line of a runway as shown in Figure H-2 (A) and (B) for a runway width of 45 m. The number of stripes must be in accordance with the runway width as follows:

| Runway width | Number of stripes |
|--------------|-------------------|
| 18 m         | 4                 |
| 23 m         | 6                 |
| 30 m         | 8                 |
| 45 m         | 12                |
| 60 m         | 16                |

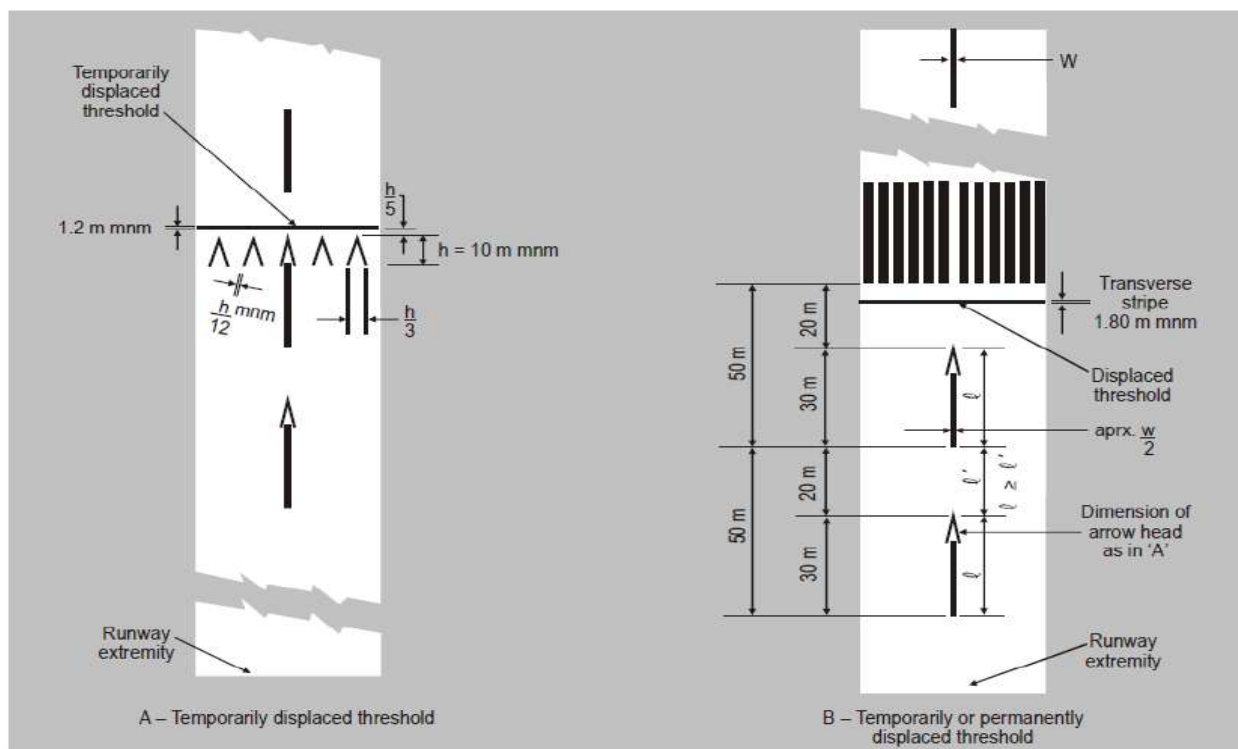
Except that on non-precision approach and non-instrument runways 45 m or greater in width, they may be as shown in Figure H-2 (C).

- (ii) The stripes must extend laterally to within 3 m of the edge of a runway or to a distance of 27 m on either side of a runway centre line, whichever results in the smaller lateral distance. Where a runway designation marking is placed within a threshold marking there must be a minimum of three stripes on each side of the centre line of the runway. Where a runway designation marking is placed above a threshold marking, the stripes must be continued across the runway. The stripes must be at least 30 m long and approximately 1.8 m wide with a spacing of approximately 1.8 m between them except that, where the stripes are continued

## GACAR PART 139 – CERTIFICATION, AUTHORIZATION AND OPERATION OF AERODROMES

across a runway, a double spacing must be used to separate the two stripes nearest the centre line of the runway, and in the case where the designation marking is included within the threshold marking this spacing must be 22.5 m.

- (4) Transverse stripe
- (i) Where a threshold is displaced from the extremity of a runway or where the extremity of a runway is not square with the runway centre line, a transverse stripe as shown in Figure H-4 (B) must be added to the threshold marking.
  - (ii) A transverse stripe must be not less than 1.80 m wide.



**Figure H-4. Displaced Threshold Marking**

- (5) Arrows
- (i) Where a runway threshold is permanently displaced, arrows conforming to Figure -4 (B) must be provided on the portion of the runway before the displaced threshold.

---

## **GACAR PART 139 – CERTIFICATION, AUTHORIZATION AND OPERATION OF AERODROMES**

---

- (ii) When a runway threshold is temporarily displaced from the normal position, it must be marked as shown in Figure H-4 (A) or Figure H-4 (B) and all markings prior to the displaced threshold must be obscured except the runway centre line marking, which must be converted to arrows.
- (e) Aiming point marking
- (1) Application
    - (i) An aiming point marking must be provided at each approach end of a paved instrument runway where the code number is 2, 3 or 4.
    - (ii) An aiming point marking must be provided at each approach end of:
      - (A) A paved non-instrument runway where the code number is 3 or 4;
      - (B) A paved instrument runway where the code number is 1; when additional conspicuity of the aiming point is desirable.
  - (2) Location
    - (i) The aiming point marking must commence no closer to the threshold than the distance indicated in the appropriate column of Table H-1, except that, on a runway equipped with a visual approach slope indicator system, the beginning of the marking must be coincident with the visual approach slope origin.
    - (ii) An aiming point marking must consist of two conspicuous stripes. The dimensions of the stripes and the lateral spacing between their inner sides must be in accordance with the provisions of the appropriate column of Table H-1. Where a touchdown zone marking is provided, the lateral spacing between the markings must be the same as that of the touchdown zone marking.

## GACAR PART 139 – CERTIFICATION, AUTHORIZATION AND OPERATION OF AERODROMES

| Location and dimensions<br>(1)                  | Landing distance available |  |  |                          |
|---|----------------------------|--|--|--------------------------|
|   | Less than 800 m<br>(2)     | 800 m up to but not including 1 200 m<br>(3) | 1 200 m up to but not including 2 400 m<br>(4) | 2 400 m and above<br>(5) |
| Distance from threshold to beginning of marking | 150 m                      | 250 m  | 300 m  | 400 m                    |
| Length of stripe <sup>a</sup>                   | 30–45 m                    | 30–45 m                                      | 45–60 m  | 45–60 m                  |
| Width of stripe                                 | 4 m                        | 6 m  | 6–10 m <sup>b</sup>                            | 6–10 m <sup>b</sup>      |
| Lateral spacing between inner sides of stripes  | 6 m <sup>c</sup>           | 9 m <sup>c</sup>                             | 18–22.5 m                                      | 18–22.5 m                |

- a. The greater dimensions of the specified ranges are intended to be used where increased conspicuity is required.
- b. The lateral spacing may be varied within these limits to minimize the contamination of the marking by rubber deposits.
- c. These figures were deduced by reference to the outer main gear wheel span.

**Table H-1. Location and dimensions of aiming point marking**

(f) Touchdown zone marking

(1) Application

- (i) A touchdown zone marking must be provided in the touchdown zone of a paved precision approach runway where the code number is 2, 3 or 4.
- (ii) A touchdown zone marking must be provided in the touchdown zone of a paved non-precision approach or non-instrument runway where the code number is 3 or 4 and additional conspicuity of the touchdown zone is desirable.

---

## GACAR PART 139 – CERTIFICATION, AUTHORIZATION AND OPERATION OF AERODROMES

---

(2) Location and characteristics

- (i) A touchdown zone marking must consist of pairs of rectangular markings symmetrically disposed about the runway centre line with the number of such pairs related to the landing distance available and, where the marking is to be displayed at both the approach directions of a runway, the distance between the thresholds, as follows:

| Landing distance available or the distance between thresholds markings | Pair(s) of markings |
|--|---------------------|
| less than 900 m  | 1                   |
| 900 m up to but not including 1,200m                                   | 2                   |
| 1,200 m up to but not including 1,500 m                                | 3                   |
| 1,500 m up to but not including 2,400 m                                | 4                   |
| 2,400 m or more  | 6                   |

- (ii) A touchdown zone marking must conform to either of the two patterns shown in Figure H-5. For the pattern shown in Figure H-5 (A), the markings must be not less than 22.5 m long and 3 m wide. For the pattern shown in Figure H-5 (B), each stripe of each marking must be not less than 22.5 m long and 1.8 m wide with spacing of 1.5 m between adjacent stripes. The lateral spacing between the inner sides of the rectangles must be equal to that of the aiming point marking where provided. Where an aiming point marking is not provided, the lateral spacing between the inner sides of the rectangles must correspond to the lateral spacing specified for the aiming point marking in Table H -1 (columns 2, 3, 4 or 5, as appropriate). The pairs of markings must be provided at longitudinal intervals of 150 m beginning from the threshold except that pairs of touchdown zone markings coincident with or located within 50 m of an aiming point marking must be deleted from the pattern.
- (iv) On a non-precision approach runway where the code number is 2, an additional pair of touchdown zone marking stripes must be provided 150 m beyond the beginning of the aiming point marking.

## **GACAR PART 139 – CERTIFICATION, AUTHORIZATION AND OPERATION OF AERODROMES**

---

### (g) Runway side stripe marking

#### (1) Application

- (i) A runway side stripe marking must be provided between the thresholds of a paved runway where there is a lack of contrast between the runway edges and the shoulders or the surrounding terrain
- (ii) A runway side stripe marking must be provided on a precision approach runway irrespective of the contrast between the runway edges and the shoulders or the surrounding terrain.

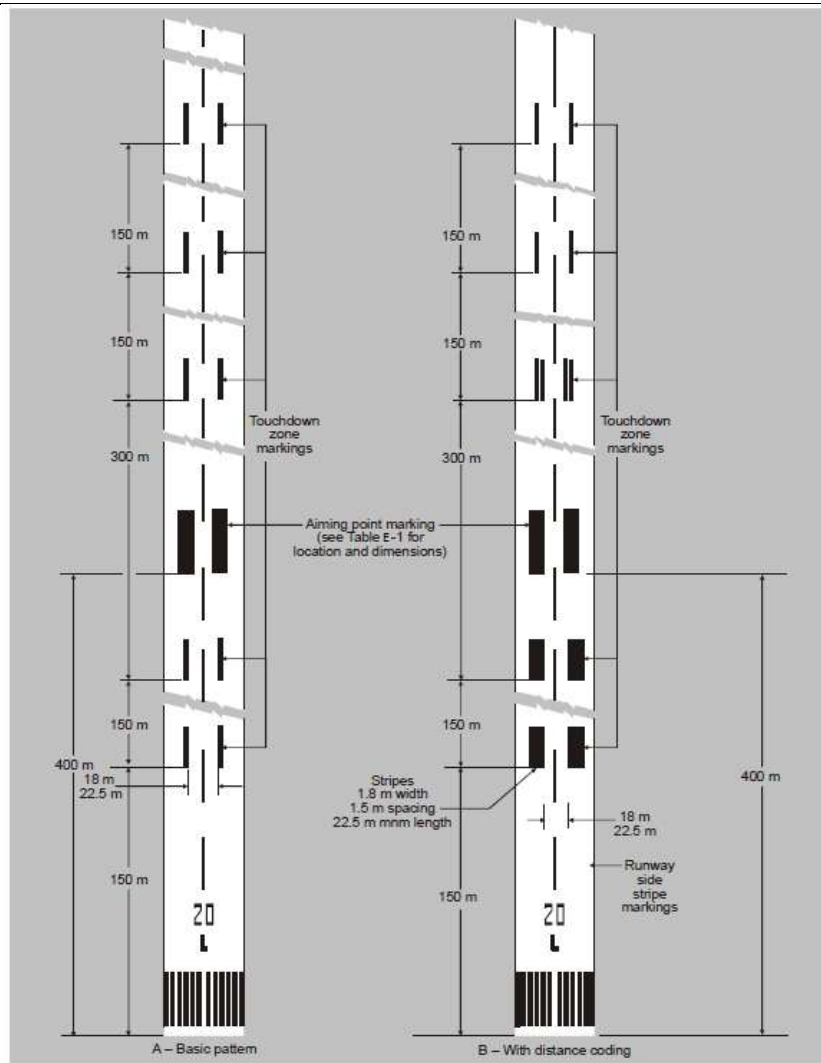
#### (2) Location

- (i) A runway side stripe marking must consist of two stripes, one placed along each edge of the runway with the outer edge of each stripe approximately on the edge of the runway, except that, where the runway is greater than 60 m in width, the stripes must be located 30 m from the runway centre line.
- (ii) Where runway turn pad is provided, the runway side stripe marking must be continued between the runway and the runway turn pad.

#### (3) Characteristics

A runway side stripe must have an overall width of at least 0.9 m on runways 30 m or more in width and at least 0.45 m on narrower runways.

## GACAR PART 139 – CERTIFICATION, AUTHORIZATION AND OPERATION OF AERODROMES



**Figure H-5. Aiming point and touchdown zone markings (illustrated for a runway with a length of 2400 m or more).**

(h) Taxiway Centre line marking

(1) Application

- (i) Taxiway centre line marking must be provided on a paved taxiway, de-icing/anti-icing facility and apron where the code number is 3 or 4 in such a way as to provide continuous guidance between the runway centre line and aircraft stands.



---

## **GACAR PART 139 – CERTIFICATION, AUTHORIZATION AND OPERATION OF AERODROMES**

---

- (ii) Taxiway centre line marking must be provided on a paved taxiway, de-icing/anti-icing facility and apron where the code number is 1 or 2 in such a way as to provide continuous guidance between the runway centre line and aircraft stands.
  - (iii) Taxiway centre line marking must be provided on a paved runway when the runway is part of a standard taxi-route and:
    - (iv) There is no runway centre line marking; or
    - (v) Where the taxiway centre line is not coincident with the runway centre line.
    - (vi) Where it is necessary to denote the proximity of a runway-holding position, enhanced taxiway centre line marking must be provided
  - (vii) Where provided, enhanced taxiway centre line marking must be installed at each taxiway/runway intersection.
- (2) Location
- (i) On a straight section of a taxiway the taxiway centre line marking must be located along the taxiway centre line. On a taxiway curve the marking must continue from the straight portion of the taxiway at a constant distance from the outside edge of the curve.  
  
Note – See § 139.317-(c) and Figure F-2.
  - (ii) At an intersection of a taxiway with a runway where the taxiway serves as an exit from the runway, the taxiway centre line marking must be curved into the runway centre line marking as shown in Figures H-6 and H-26. The taxiway centre line marking must be extended parallel to the runway centre line marking for a distance of at least 60 m beyond the point of tangency where the code number is 3 or 4, and for a distance of at least 30 m where the code number is 1 or 2.
  - (iii) Where provided:
    - (A) An enhanced taxiway centre line marking must extend from the runway-holding position Pattern A (as defined in Figure H-6, Taxiway markings) to a distance of up to 47m in the direction of travel away from the runway. See Figure H-7 (a).
    - (B) If the enhanced taxiway centre line marking intersects another runway-holding position marking, such as for a precision approach category II or III runway that is located within 47m of the first runway-holding position marking, the enhanced taxiway centre line marking must be interrupted 0.9m prior to and after the intersected runway-holding position marking. The enhanced taxiway centre line marking must continue beyond the intersected runway-holding position

---

## **GACAR PART 139 – CERTIFICATION, AUTHORIZATION AND OPERATION OF AERODROMES**

---

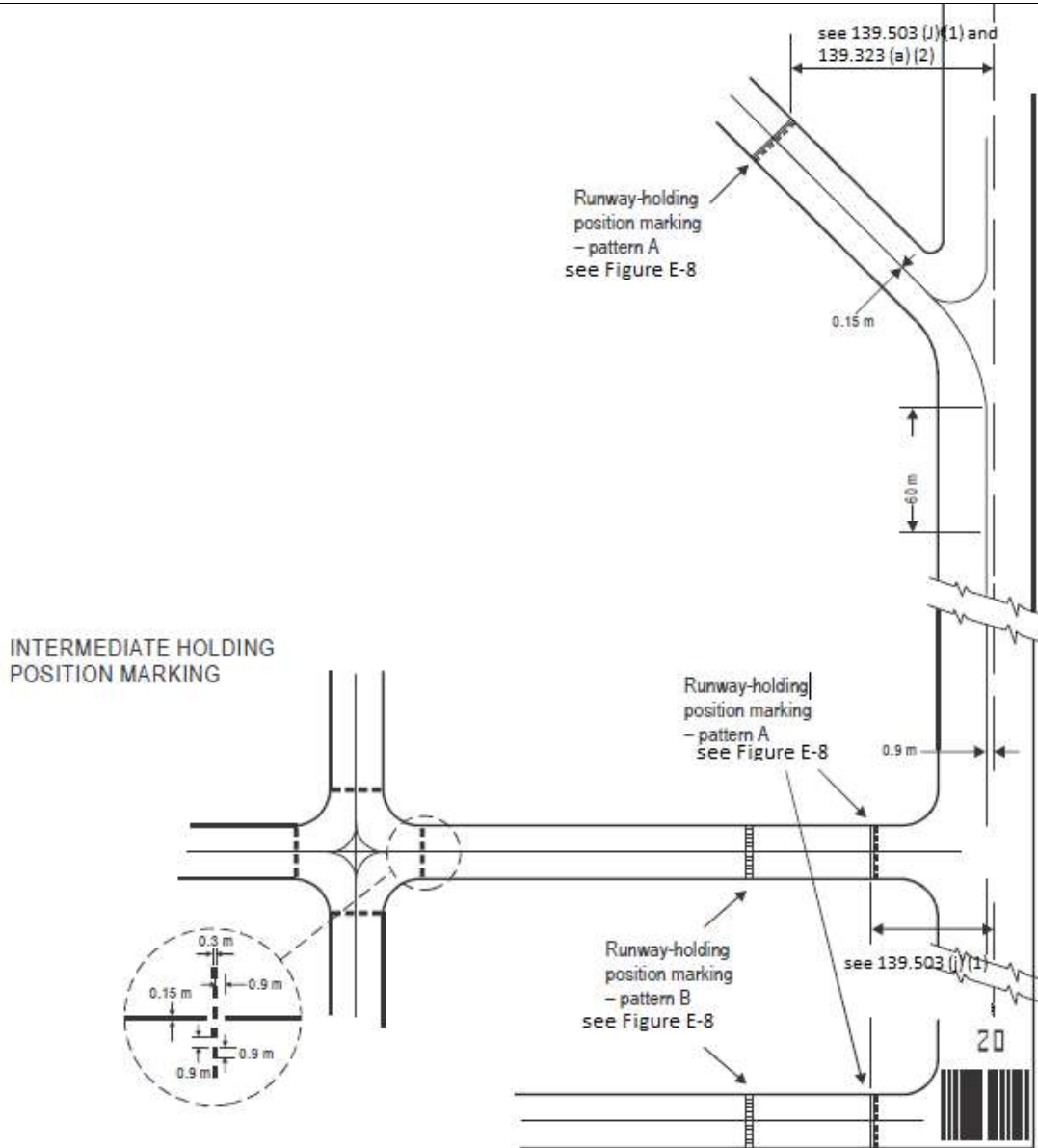
marking for at least 3 dashed line segments or 47m from start to finish, whichever is greater. See Figure H-7 (b).

- (C) If the enhanced taxiway centre line marking continues through a taxiway/taxiway intersection that is located within 47m of the runway-holding position marking, the enhanced taxiway centre line marking must be interrupted 1.5m prior to and after the point where the intersected taxiway centre line crosses the enhanced taxiway centre line. The enhanced taxiway centre line marking must continue beyond the taxiway/taxiway intersection for at least 3 dashed line segments or 47m from start to finish, whichever is greater. See Figure H-7 (c).
- (D) Where two taxiway centre lines converge at or before the runway-holding position marking, the inner dashed line must not be less than 3m in length. See Figure H-7 (d).
- (E) Where there are two opposing runway-holding position markings and the distance between the markings is less than 94m, the enhanced taxiway centre line markings must extend over this entire distance. The enhanced taxiway centre line markings must not extend beyond either runway-holding position marking. See Figure H-7 (e).

(3) Characteristics

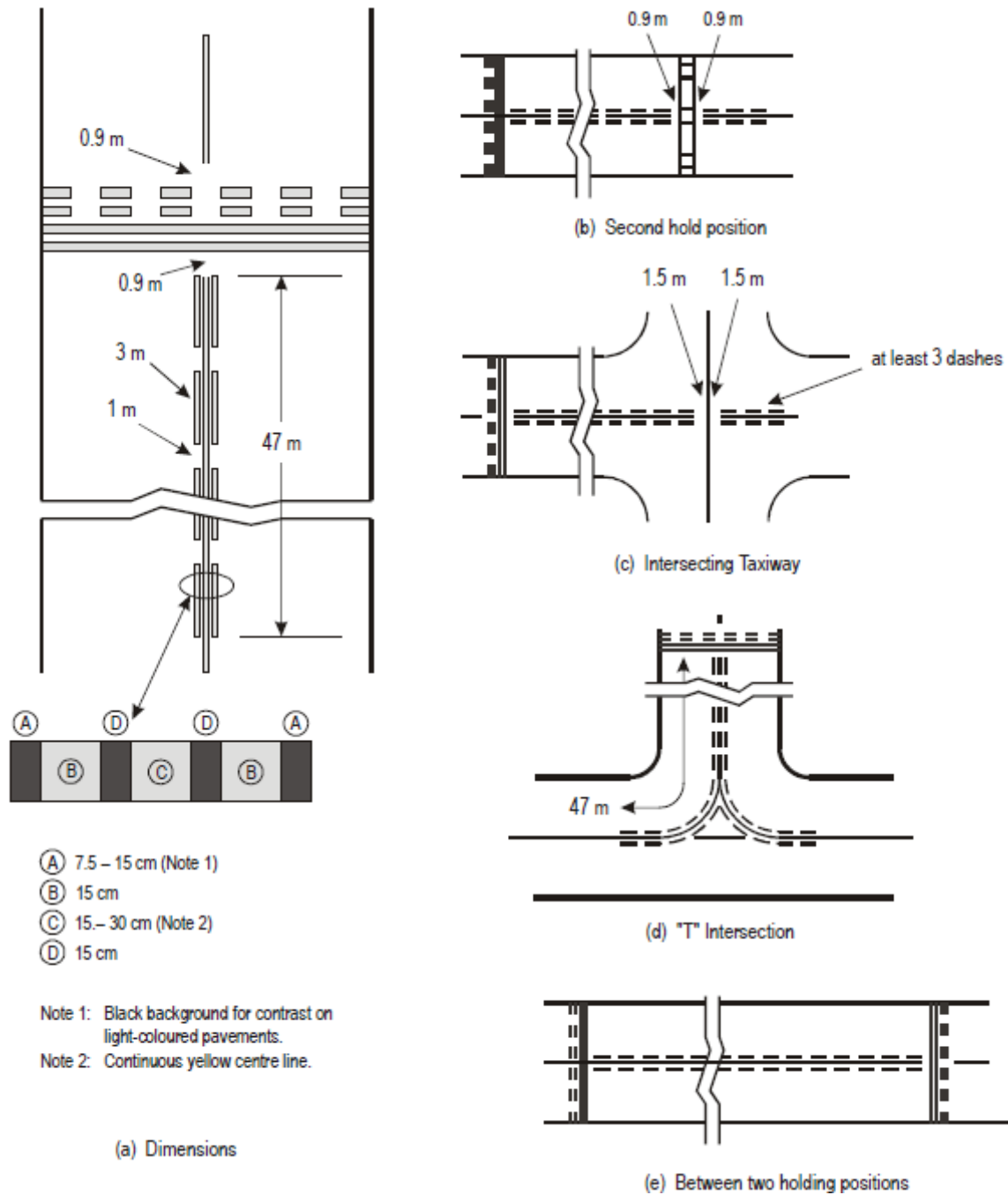
- (i) A taxiway centre line marking must be at least 15 cm in width and continuous in length except where it intersects with a runway holding position marking or an intermediate holding position marking as shown in Figure H-6.
- (ii) Enhanced taxiway centre line marking must be as shown in Figure H-7(e).

**GACAR PART 139 – CERTIFICATION, AUTHORIZATION AND OPERATION OF AERODROMES**



**Figure H-6. Taxiway Markings (Shown with basic runway markings).**

## GACAR PART 139 – CERTIFICATION, AUTHORIZATION AND OPERATION OF AERODROMES



**Figure H-7. Enhanced Taxiway centre line marking.**

---

## **GACAR PART 139 – CERTIFICATION, AUTHORIZATION AND OPERATION OF AERODROMES**

---

### (i) Runway turn pad marking

#### (1) Application

Where a runway turn pad is provided, a runway turn pad marking must be provided for continuous guidance to enable an aeroplane to complete a 180-degree turn and align with the runway centre line.

#### (2) Location

- (i) The runway turn pad marking must be curved from the runway centre line into the turn pad. The radius of the curve must be compatible with the manoeuvring capability and normal taxiing speeds of the aeroplanes for which the runway turn pad is intended. The intersection angle of the runway turn pad marking with the runway centre line must not be greater than 30 degrees.
- (ii) The runway turn pad marking must be extended parallel to the runway centre line marking for a distance of at least 60 m beyond the point of tangency where the code number is 3 or 4, and for a distance of at least 30 m where the code number is 1 or 2.
- (iii) A runway turn pad marking must guide the aero plane in such a way as to allow a straight portion of taxiing before the point where a 180-degree turn is to be made. The straight portion of the runway turn pad marking must be parallel to the outer edge of the runway turn pad.
- (iv) The design of the curve allowing the aeroplane to negotiate a 180-degree turn must be based on a nose wheel steering angle not exceeding 45 degrees.
- (v) The design of the turn pad marking must be such that, when the cockpit of the aeroplane remains over the runway turn pad marking, the clearance distance between any wheel of the aeroplane landing gear and the edge of the runway turn pad must be not less than those specified in § 139.305-(a)-(6).

#### (3) Characteristics

A runway turn pad marking must be at least 15 cm in width and continuous in length.

### (j) Runway-holding position marking

#### (1) Application and location

A runway-holding position marking must be displayed along a runway-holding position.

#### (2) Characteristics

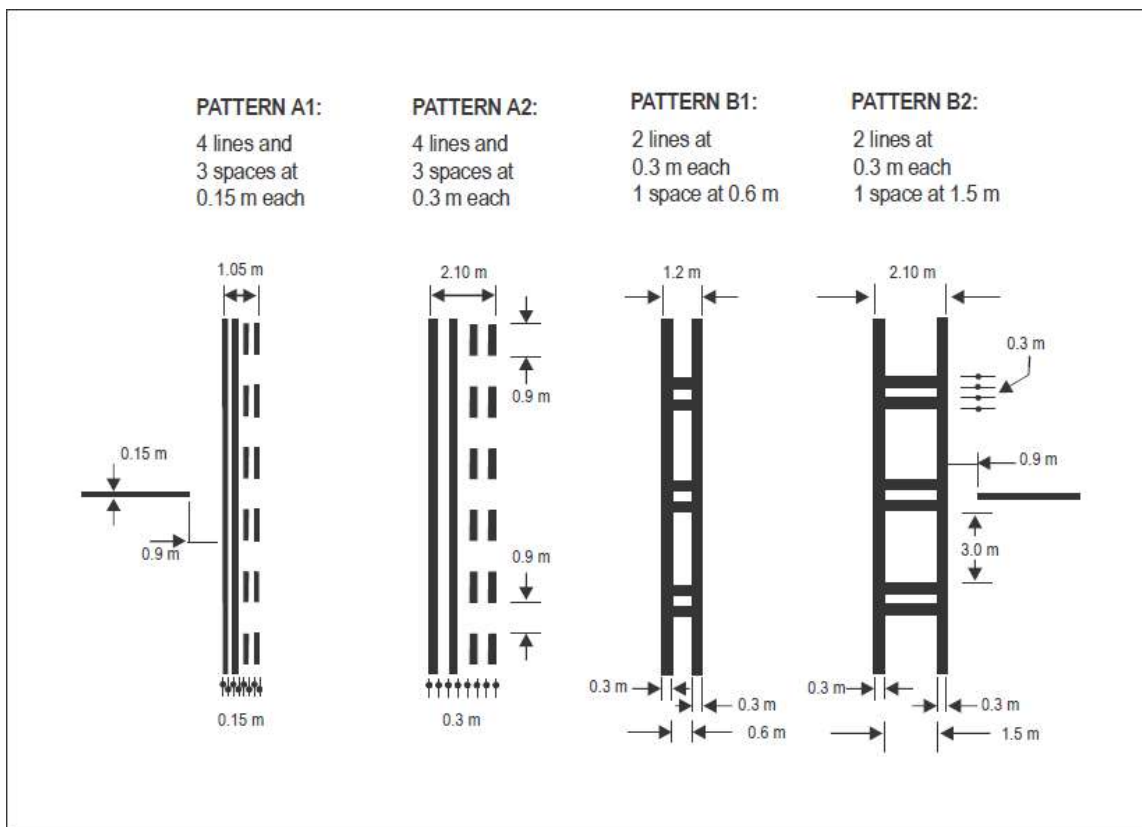
---

## **GACAR PART 139 – CERTIFICATION, AUTHORIZATION AND OPERATION OF AERODROMES**

---

- (i) At an intersection of a taxiway and a non-instrument, non-precision approach or take-off runway, the runway-holding position marking must be as shown in Figure H-6, pattern A.
- (ii) Where a single runway-holding position is provided at an intersection of a taxiway and a precision approach category I, II or III runway, the runway-holding position marking must be as shown in Figure H-6, pattern A. Where two or three runway-holding positions are provided at such an intersection, the runway-holding position marking closer (closest) to the runway must be as shown in Figure H-6, pattern A and the markings farther from the runway must be as shown in Figure H-6, pattern B.
- (iii) The runway-holding position marking displayed at a runway-holding position established in accordance with § 139.323-(a)-(3) must be as shown in Figure H-6, pattern A.
- (iv) Until 26 November 2026, the dimensions of runway-holding position markings must be as shown in Figure H-8, pattern A1 (or A2) or pattern B1 (or B2), as appropriate.
- (v) As of 26 November 2026, the dimensions of runway-holding position markings must be as shown in Figure H-8, pattern A2 or pattern B2, as appropriate.
- (vi) Where increased conspicuity of the runway-holding position is required, the dimensions of runway-holding position marking must be as shown in Figure H-8, pattern A2 or pattern B2 as appropriate.
- (vii) Where a pattern B runway-holding position marking is located on an area where it would exceed 60 m in length, the term “CAT II” or “CAT III” as appropriate must be marked on the surface at the ends of the runway-holding position marking and at equal intervals of 45 m maximum between successive marks. The letters must be not less than 1.8 m high and must be placed not more than 0.9 m beyond the holding position marking.
- (viii) The runway-holding position marking displayed at a runway/runway intersection must be perpendicular to the centre line of the runway forming part of the standard taxi-route. The pattern of the marking must be as shown in Figure H-8, Pattern A2.

## GACAR PART 139 – CERTIFICATION, AUTHORIZATION AND OPERATION OF AERODROMES



**Figure H-8. Runway-holding position markings**

- (k) Intermediate holding position marking
  - (1) Application and location
    - (i) An intermediate holding position marking must be displayed along an intermediate holding position.
    - (ii) An intermediate holding position marking must be displayed at the exit boundary of a remote de-icing/anti-icing facility adjoining a taxiway.
    - (iii) Where an intermediate holding position marking is displayed at an intersection of two paved taxiways, it must be located across the taxiway at sufficient distance

---

## GACAR PART 139 – CERTIFICATION, AUTHORIZATION AND OPERATION OF AERODROMES

---

from the near edge of the intersecting taxiway to ensure safe clearance between taxiing aircraft. It must be coincident with a stop bar or intermediate holding position lights, where provided.

- (iv) The distance between an intermediate holding position marking at the exit boundary of a remote de-icing/ anti-icing facility and the centre line of the adjoining taxiway must not be less than the dimension specified in Table F-1, column 11.

(2) Characteristics

An intermediate holding position marking must consist of a single broken line as shown in Figure H-6.

(1) VOR Aerodrome check-point marking

(1) Application

- (i) When a VOR Aerodrome checkpoint is established, it must be indicated by a VOR Aerodrome checkpoint marking and sign.

*Note.* — See 139.507-(d)-(3)-(ii) for VOR Aerodrome checkpoint sign

- (ii) Site selection

*Note.* — Guidance on the selection of sites for VOR aerodrome checkpoints is given in Annex 10, Volume I, Attachment E.

(2) Location

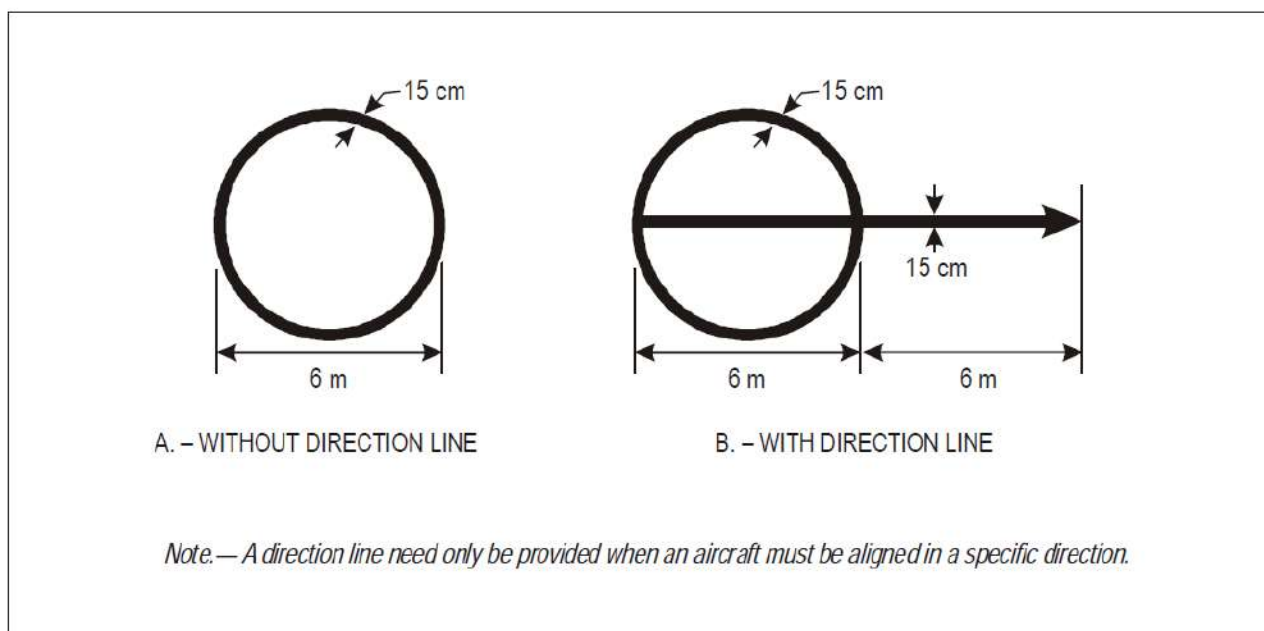
A VOR Aerodrome check-point marking must be centred on the spot at which an aircraft is to be parked to receive the correct VOR signal.

(3) Characteristics

- (i) A VOR aerodrome checkpoint marking must consist of a circle 6 m in diameter and have a line width of 15 cm (see Figure H-9 (A)).
- (ii) When it is preferable for an aircraft to be aligned in a specific direction, a line must be provided that passes through the centre of the circle on the desired azimuth. The line must extend 6 m outside the circle in the desired direction of heading and terminate in an arrowhead. The width of the line must be 15 cm (see Figure H-9 (B)).
- (iii) A VOR Aerodrome checkpoint marking must preferably be white in color but must differ from the color used for the taxiway markings.



## GACAR PART 139 – CERTIFICATION, AUTHORIZATION AND OPERATION OF AERODROMES



**Figure H-9. VOR Aerodrome checkpoint marking.**

(m) Aircraft stand markings

(1) Application

Aircraft stand markings must be provided for designated parking positions on a paved apron and on a de-icing/anti-icing facility.

(2) Location

Aircraft stand markings on a paved apron and on a de-icing/anti-icing facility must be located so as to provide the clearances specified in § 139.325-(e)-(1) and in § 139.329-(f)-(1) respectively, when the nose wheel follows the stand marking.

(3) Characteristics

---

## **GACAR PART 139 – CERTIFICATION, AUTHORIZATION AND OPERATION OF AERODROMES**

---

- (i) Aircraft stand markings must include such elements as stand identification, lead-in line, turn bar, turning line, alignment bar, stop line and lead-out line, as are required by the parking configuration and to complement other parking aids.
- (ii) An aircraft stand identification (letter and/or number) must be included in the lead-in line a short distance after the beginning of the lead-in line. The height of the identification must be adequate to be readable from the cockpit of aircraft using the stand.
- (iii) Where two sets of aircraft stand markings are superimposed on each other in order to permit more flexible use of the apron and it is difficult to identify which stand marking must be followed, or safety would be impaired if the wrong marking was followed, then identification of the aircraft for which each set of markings is intended must be added to the stand identification.
- (iv) Lead-in, turning and lead-out lines must normally be continuous in length and have a width of not less than 15 cm. Where one or more sets of stand markings are superimposed on a stand marking, the lines must be continuous for the most demanding aircraft and broken for other aircraft.
- (v) The curved portions of lead-in, turning and lead-out lines must have radii appropriate to the most demanding aircraft type for which the markings are intended.
- (vi) Where it is intended that an aircraft proceed in one direction only, arrows pointing in the direction to be followed must be added as part of the lead-in and lead-out lines.
- (vii) A turn bar must be located at right angles to the lead-in line, abeam the left pilot position at the point of initiation of any intended turn. It must have a length and width of not less than 6 m and 15 cm, respectively, and include an arrowhead to indicate the direction of turn.
- (viii) If more than one turn bar and / or stop line is required, they must be coded.
- (ix) An alignment bar must be placed so as to be coincident with the extended centre line of the aircraft in the specified parking position and visible to the pilot during the final part of the parking manoeuvre. It must have a width of not less than 15 cm.
- (x) A stop line must be located at right angles to the alignment bar, abeam the left pilot position at the intended point of stop. It must have a length and width of not less than 6 m and 15 cm, respectively.

---

## **GACAR PART 139 – CERTIFICATION, AUTHORIZATION AND OPERATION OF AERODROMES**

---

### (n) Apron safety lines

(1) Application

Apron safety lines must be provided on a paved apron as required by the parking configurations and ground facilities.

(2) Location

Apron safety lines must be located so as to define the areas intended for use by ground vehicles and other aircraft servicing equipment, etc., to provide safe separation from aircraft.

(3) Characteristics

- (i) Apron safety lines must include such elements as wing tip clearance lines and service road boundary lines as required by the parking configurations and ground facilities.
- (ii) An apron safety line must be continuous in length and at least 10 cm in width. The safety line must be red in color.

### (o) Road-holding position marking

(1) Application

A road-holding position marking must be provided at all road entrances to a runway.

(2) Location

The road-holding position marking must be located across the road at the holding position.

(3) Characteristics

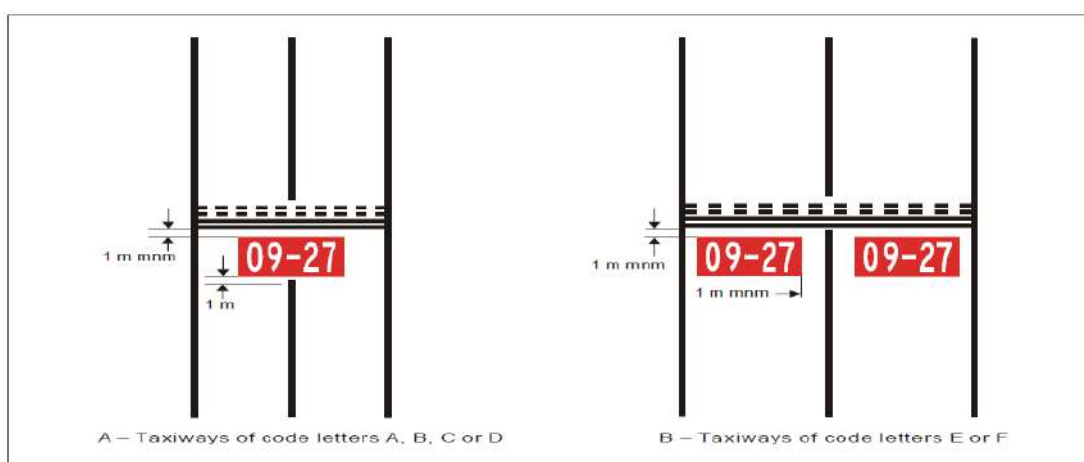
The road-holding position marking must be in accordance with the local road traffic regulations.

## GACAR PART 139 – CERTIFICATION, AUTHORIZATION AND OPERATION OF AERODROMES

### (p) Mandatory instruction marking

#### (1) Application

Where it is impracticable to install a mandatory instruction sign in accordance with § 139.507-(b)-(1)-(i), a mandatory instruction marking must be provided on the surface of the pavement.



**Figure H-10. Mandatory instruction marking.**

#### (2) Location

- (i) The mandatory instruction marking on taxiways where the code letter is A, B, C or D must be located across the taxiway equally placed about the taxiway centre line and on the holding side of the runway-holding position marking as shown in Figure H-10 (A). The distance between the nearest edge of the marking and the runway-holding position marking or the taxiway centre line marking must be not less than 1 m.
- (ii) The mandatory instruction marking on taxiways where the code letter is E or F must be located on both sides of the taxiway centre line marking and on the holding side of the runway-holding position marking as shown in Figure H-10 (B). The distance between the nearest edge of the marking and the runway-holding position marking or the taxiway centre line marking must be not less than 1 m.

#### (3) Characteristics

---

## **GACAR PART 139 – CERTIFICATION, AUTHORIZATION AND OPERATION OF AERODROMES**

---

- (i) A mandatory instruction marking must consist of an inscription in white on a red background. Except for a NO ENTRY marking, the inscription must provide information identical to that of the associated mandatory instruction sign.
- (ii) A NO ENTRY marking must consist of an inscription in white reading NO ENTRY on a red background.
- (iii) Where there is insufficient contrast between the marking and the pavement surface, the mandatory instruction marking must include an appropriate border, preferably white or black.
- (iv) The character height must be 4 m. for inscriptions where the code letter is C, D, E or F, and 2 m where the code letter is A or B. The inscriptions must be in the form and proportions shown in Appendix H.
- (v) The background must be rectangular and extend a minimum of 0.5 m laterally and vertically beyond the extremities of the inscription.

### (q) Information marking

#### (1) Application

- (i) Where an information sign would normally be installed and is impractical to install, as determined by the President, an information marking must be displayed on the surface of the pavement.
- (ii) Where operationally required an information sign must be supplemented by an information marking.
- (iii) An information (location/direction) marking must be displayed prior to and following complex taxiway intersections and where operational experience has indicated the addition of a taxiway location marking could assist flight crew ground navigation.
- (iv) An information (location) marking must be displayed on the pavement surface at regular intervals along taxiways of great length.

#### (2) Location

The information marking must be displayed across the surface of the taxiway or apron and positioned so as to be legible from the cockpit of an approaching aircraft.

#### (3) Characteristics

- (i) An information marking must consist of:
  - (A) An inscription in yellow upon a black background, when it replaces or supplements a location sign; and

---

## **GACAR PART 139 – CERTIFICATION, AUTHORIZATION AND OPERATION OF AERODROMES**

---

- (B) An inscription in black upon a yellow background, when it replaces or supplements a direction or destination sign.
- (ii) Where there is insufficient contrast between the marking background and the pavement surface, the marking must include:
  - (A) A black border where the inscriptions are in black; and
  - (B) A yellow border where the inscriptions are in yellow.
- (iii) The character height must be 4 m. The inscriptions must be in the form and proportions shown in Appendix H.

### **§ 139.505 Lights**

#### (a) General

- (1) Lights which may endanger the safety of aircraft

A non-aeronautical ground light near an aerodrome which might endanger the safety of aircraft must be extinguished, screened or otherwise modified so as to eliminate the source of danger.

- (2) Laser emissions which may endanger the safety of aircraft

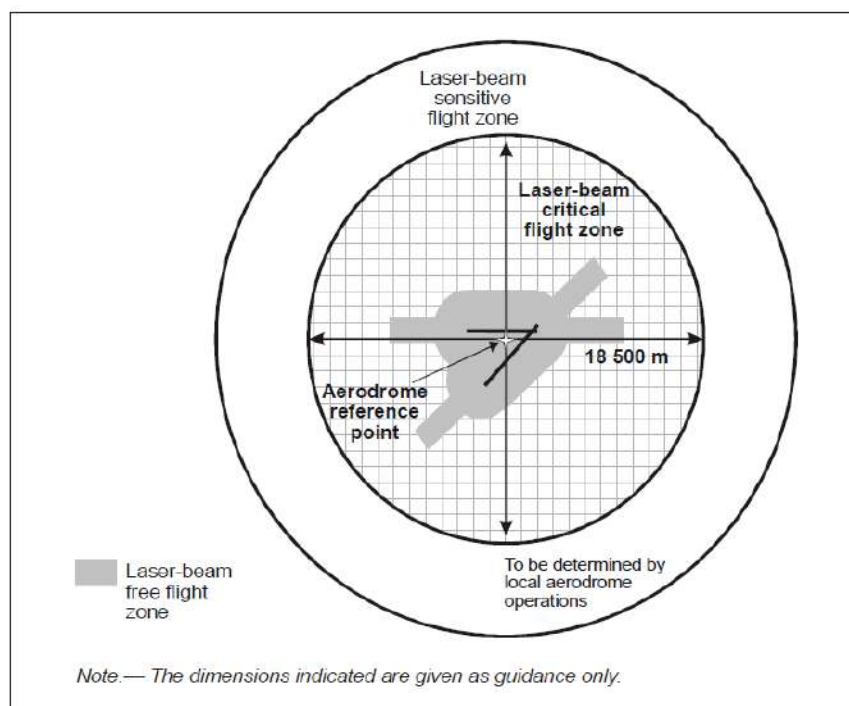
To protect the safety of aircraft against the hazardous effects of laser emitters, the following protected zones must be established around aerodromes:

- (i) A laser-beam free flight zone (LFFZ)
  - (ii) A laser-beam critical flight zone (LCFZ)
  - (iii) A laser-beam sensitive flight zone (LSFZ).
- (3) Lights which may cause confusion

A non-aeronautical ground light which, by reason of its intensity, configuration or color, might prevent, or cause confusion in, the clear interpretation of aeronautical ground lights must be extinguished, screened or otherwise modified so as to eliminate such a possibility. In particular, attention must be directed to a non-aeronautical ground light visible from the air within the areas described hereunder:

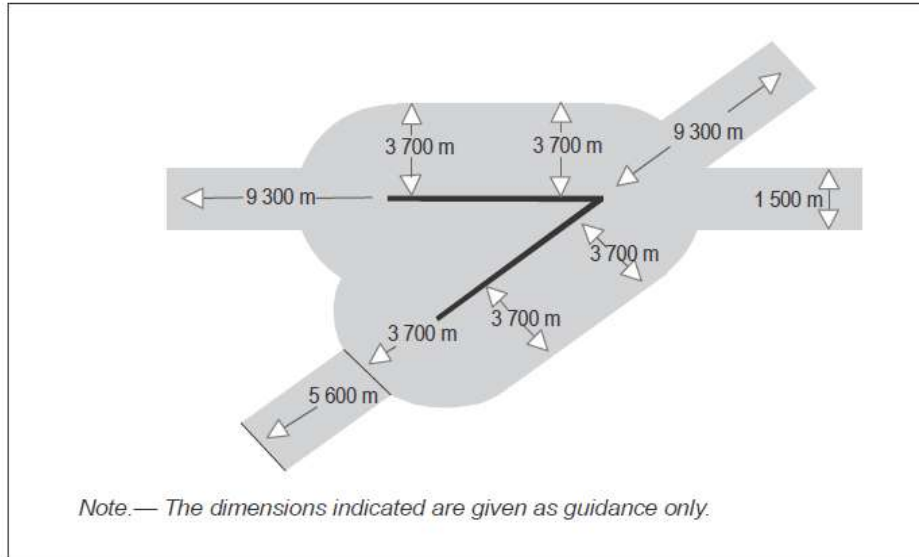
## GACAR PART 139 – CERTIFICATION, AUTHORIZATION AND OPERATION OF AERODROMES

- (i) Instrument runway — code number 4: within the areas before the threshold and beyond the end of the runway extending at least 4,500 m in length from the threshold and runway end and 750 m either side of the extended runway centre line in width.
- (ii) Instrument runway — code number 2 or 3: as in a), except that the length must be at least 3,000 m.
- (iii) Instrument runway — code number 1; and non-instrument runway: within the approach area.

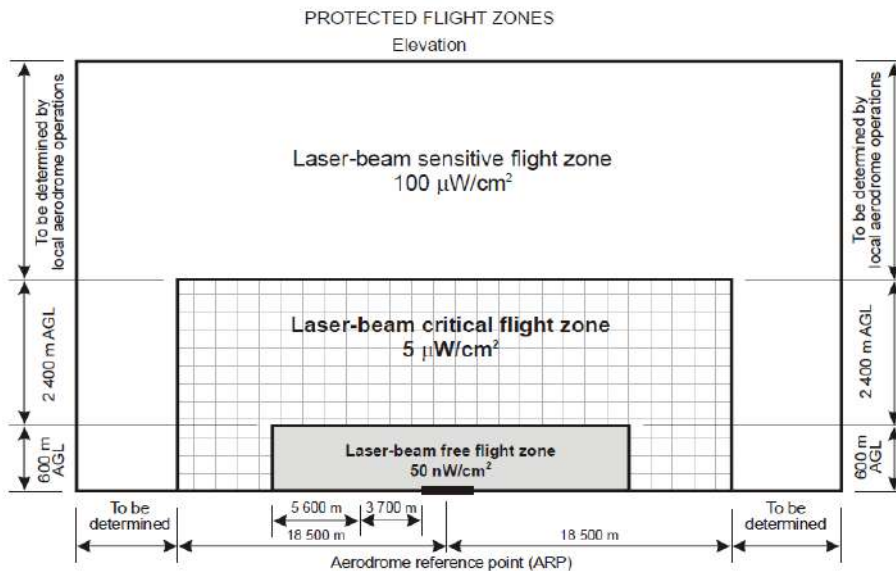


**Figure H-11. Protected Flight Zone**

## GACAR PART 139 – CERTIFICATION, AUTHORIZATION AND OPERATION OF AERODROMES



**Figure H-12. Multiple runway laser-beam flight zone**



**Figure H-13. Protected flight zones with indication of maximum irradiance levels for visible laser beams**

- (4) Aeronautical ground lights which may cause confusion to mariners



---

## **GACAR PART 139 – CERTIFICATION, AUTHORIZATION AND OPERATION OF AERODROMES**

---

In the case of aeronautical ground lights near navigable waters, consideration needs to be given to ensuring that the lights do not cause confusion to mariners.

- (5) Elevated approach lights
  - (i) Elevated approach lights and their supporting structures must be frangible except that, in that portion of the approach lighting system beyond 300 m from the threshold:
    - (A) Where the height of a supporting structure exceeds 12 m, the frangibility requirement must apply to the top 12 m only; and
    - (B) Where a supporting structure is surrounded by non-frangible objects, only that part of the structure that extends above the surrounding objects must be frangible.
  - (ii) When an approach light fixture or supporting structure is not in itself sufficiently conspicuous, it must be suitably marked.
- (6) Elevated lights

Elevated runway, stopway and taxiway lights must be frangible. Their height must be sufficiently low to preserve clearance for propellers and for the engine pods of jet aircraft.
- (7) Surface lights

Light fixtures inset in the surface of runways, stopways, taxiways and aprons must be so designed and fitted as to withstand being run over by the wheels of an aircraft without damage either to the aircraft or to the lights themselves.
- (8) Light intensity and control
  - (i) The intensity of runway lighting must be adequate for the minimum conditions of visibility and ambient light in which use of the runway is intended, and compatible with that of the nearest section of the approach lighting system when provided.
  - (ii) Where a high-intensity lighting system is provided, a suitable intensity control must be incorporated to allow for adjustment of the light intensity to meet the prevailing conditions. Separate intensity controls or other suitable methods must be provided to ensure that the following systems, when installed, can be operated at compatible intensities:

---

## GACAR PART 139 – CERTIFICATION, AUTHORIZATION AND OPERATION OF AERODROMES

---

- (A) Approach lighting system;
  - (B) Runway edge lights;
  - (C) Runway threshold lights;
  - (D) Runway end lights;
  - (E) Runway centre line lights;
  - (F) Runway touchdown zone lights; and
  - (G) Taxiway centre line lights.
- (iii) On the perimeter of and within the ellipse defining the main beam in Appendix H, Figures AE-6 to AE-15, the maximum light intensity value must not be greater than three times the minimum light intensity value measured in accordance with Appendix H, collective notes for Figures AH-6 to AH-16 and AH-30, note 2.
- (iv) On the perimeter of and within the rectangle defining the main beam in Appendix H, Figures AE-17 to AE-25 the maximum light intensity value must not be greater than three times the minimum light intensity value measured in accordance with Appendix H, collective notes for figures AE-17 to AE-26, note 2.
- (b) Emergency lighting
- (1) Application

At an aerodrome provided with runway lighting and without a secondary power supply, sufficient emergency lights must be conveniently available for installation on at least the primary runway in the event of failure of the normal lighting system.
  - (2) Location

When installed on a runway the emergency lights must, as a minimum, conform to the configuration required for a non-instrument runway.
  - (3) Characteristics

The color of the emergency lights must conform to the color requirements for runway lighting, except that, where the provision of colored lights at the threshold and the runway end is not practicable, all lights may be variable white or as close to variable white as practicable.
- (c) Aeronautical beacons
- (1) Application
    - (i) Where operationally necessary an aerodrome beacon or an identification beacon must be provided at each aerodrome intended for use at night.

---

## GACAR PART 139 – CERTIFICATION, AUTHORIZATION AND OPERATION OF AERODROMES

---

- (ii) The operational requirement must be determined having regard to the requirements of the air traffic using the aerodrome, the conspicuity of the aerodrome features in relation to its surroundings and the installation of other visual and non-visual aids useful in locating the aerodrome.

(2) Aerodrome beacon

An aerodrome beacon must be provided at an aerodrome intended for use at night if one or more of the following conditions exist:

- Aircraft navigate predominantly by visual means;
- Reduced visibilities are frequent; or
- It is difficult to locate the Aerodrome from the air due to surrounding lights or terrain.

(i) Location

- (A) The aerodrome beacon must be located on or adjacent to the aerodrome in an area of low ambient background lighting.
- (B) The location of the beacon must be such that the beacon is not shielded by objects in significant directions and does not dazzle a pilot approaching to land.

(ii) Characteristics

- (A) The Aerodrome beacon must show either colored flashes alternating with white flashes, or white flashes only. The frequency of total flashes must be from the beacon is not shielded by objects in significant directions and does. Where used, the colored flashes emitted by beacons at land Aerodromes must be green and colored flashes emitted by beacons at water Aerodromes must be yellow. In the case of a combined water and land Aerodrome, colored flashes, if used, must have the color characteristics of whichever section of the Aerodrome is designated as the principal facility.
- (B) The light from the beacon must show at all angles of azimuth. The vertical light distribution must extend upwards from an elevation of not more than 1° to an elevation determined by the President to be sufficient to provide guidance at the maximum elevation at which the beacon is intended to be used and the effective intensity of the flash must be not less than 2,000 cd.

(3) Identification beacon

(i) Application

---

## **GACAR PART 139 – CERTIFICATION, AUTHORIZATION AND OPERATION OF AERODROMES**

---

An identification beacon must be provided at an aerodrome which is intended for use at night and cannot be easily identified from the air by other means.

(ii) Location

- (A) The identification beacon must be located on the aerodrome in an area of low ambient background lighting.
- (B) The location of the beacon must be such that the beacon is not shielded by objects in significant directions and does not dazzle a pilot approaching to land.

(iii) Characteristics

- (A) An identification beacon at a land aerodrome must show at all angles of azimuth. The vertical light distribution must extend upwards from an elevation of not more than 1° to an elevation determined by the President to be sufficient to provide guidance at the maximum elevation at which the beacon is intended to be used and the effective intensity of the flash must be not less than 2,000 cd.
- (B) An identification beacon must show flashing green at a land aerodrome and flashing-yellow at a water Aerodrome.
- (C) The identification characters must be transmitted in the International Morse Code.
- (D) The speed of transmission must be between six and eight words per minute, the corresponding range of duration of the Morse dots being from 0.15 to 0.2 seconds per dot.

(d) Approach lighting systems

(1) Application

(i) Application

- (A) Non-instrument runway

Where physically practicable, a simple approach lighting system as specified in § 139.505-(d)-(2) - (i) - (A) to § 139.505-(d)-(2) - (ii) -(C) must be provided to serve a non-instrument runway where the code number is 3 or 4 and intended for use at night, except when the runway is used only in conditions of good visibility, and sufficient guidance is provided by other visual aids.

- (B) Non-precision approach runway

---

## **GACAR PART 139 – CERTIFICATION, AUTHORIZATION AND OPERATION OF AERODROMES**

---

Where physically practicable, a simple approach lighting system as specified in § 139.505-(d)-(2) -(i) -(A) to § 139.505-(d)-(2)-(ii)-(C) must be provided to serve a non-precision approach runway, except when the runway is used only in conditions of good visibility or sufficient guidance is provided by other visual aids.

(C) Precision approach runway category I

Where physically practicable, a precision approach category I lighting system as specified in § 139.505-(d)-(3) - (i) - (A) to § 139.505-(d)-(3)-(ii)-(H) must be provided to serve a precision approach runway category I.

(D) Precision approach runway categories II and III

A precision approach category II and III lighting system as specified in § 139.505-(d)-(4) - (i) - (A) to § 139.505-(d)-(4)-(ii)-(J) must be provided to serve a precision approach runway category II or III.

(2) Simple approach lighting system

(i) Location

- (A) A simple approach lighting system must consist of a row of lights on the extended centre line of the runway extending, whenever possible, over a distance of not less than 420 m from the threshold with a row of lights forming a crossbar 18 m or 30 m in length at a distance of 300 m from the threshold.
- (B) The lights forming the crossbar must be as nearly as practicable in a horizontal straight line at right angles to, and bisected by, the line of the centre line lights. The lights of the crossbar must be spaced so as to produce a linear effect, except that, when a crossbar of 30 m is used, gaps may be left on each side of the centre line. These gaps must be kept to a minimum to meet local requirements and each must not exceed 6 m.
- (C) The lights forming the centre line must be placed at longitudinal intervals of 60 m, except that, when it is desired to improve the guidance, an interval of 30 m may be used. The innermost light must be located either 60 m or 30 m from the threshold, depending on the longitudinal interval selected for the centre line lights.
- (D) If it is not physically possible to provide a centre line extending for a distance of 420 m from the threshold, it must be extended to 300 m so as to include the crossbar. If this is not possible, the centre line lights must be extended as far as practicable, and each centre line light must then consist of a barrette at least 3 m

---

## **GACAR PART 139 – CERTIFICATION, AUTHORIZATION AND OPERATION OF AERODROMES**

---

- in length. Subject to the approach system having a crossbar at 300 m from the threshold, an additional crossbar may be provided at 150 m from the threshold.
- (E) The system must lie as nearly as practicable in the horizontal plane passing through the threshold, provided that:
- (I) No object other than an ILS or MLS azimuth antenna must protrude through the plane of the approach lights within a distance of 60 m from the centre line of the system; and
  - (II) No light other than a light located within the central part of a crossbar or a centre line barrette (not their extremities) must be screened from an approaching aircraft. Any ILS or MLS azimuth antenna protruding through the plane of the lights must be treated as an obstacle and marked and lighted accordingly.
- (ii) Characteristics
- (A) The lights of a simple approach lighting system must be fixed lights and the color of the lights must be such as to ensure that the system is readily distinguishable from other aeronautical ground lights, and from extraneous lighting if present. Each centre line light must consist of either:
    - (I) A single source; or
    - (II) A barrette at least 3 m in length.
  - (B) Where provided for a non-instrument runway, the lights must show at all angles in azimuth necessary to a pilot on base leg and final approach. The intensity of the lights must be adequate for all conditions of visibility and ambient light for which the system has been provided.
  - (C) Where provided for a non-precision approach runway, the lights must show at all angles in azimuth necessary to the pilot of an aircraft which on final approach does not deviate by an abnormal amount from the path defined by the non-visual aid. The lights must be designed to provide guidance during both day and night in the most adverse conditions of visibility and ambient light for which it is intended that the system must remain usable.
- (3) Precision approach category I lighting system
- (i) Location
    - (A) A precision approach category I lighting system must consist of a row of lights on the extended centre line of the runway extending, wherever possible, over a distance of 900 m from the runway threshold with a row of lights forming a crossbar 30 m in length at a distance of 300 m from the runway threshold.
    - (B) The lights forming the crossbar must be as nearly as practicable in a horizontal straight line at right angles to, and bisected by, the line of the centre line lights.

---

## **GACAR PART 139 – CERTIFICATION, AUTHORIZATION AND OPERATION OF AERODROMES**

---

- The lights of the crossbar must be spaced so as to produce a linear effect, except that gaps may be left on each side of the centre line. These gaps must be kept to a minimum to meet local requirements and each must not exceed 6 m.
- (C) The lights forming the centre line must be placed at longitudinal intervals of 30 m with the innermost light located 30 m from the threshold.
  - (D) The system must lie as nearly as practicable in the horizontal plane passing through the threshold, provided that:
    - (I) No object other than an ILS or MLS azimuth antenna must protrude through the plane of the approach lights within a distance of 60 m from the centre line of the system; and
    - (II) No light other than a light located within the central part of a crossbar or a centre line barrette (not their extremities) must be screened from an approaching aircraft. Any ILS or MLS azimuth antenna protruding through the plane of the lights must be treated as an obstacle and marked and lighted accordingly.
- (ii) Characteristics
- (A) The centre line and crossbar lights of a precision approach category I lighting system must be fixed lights showing variable white. Each centre line light position must consist of either:
    - (I) A single light source in the innermost 300 m of the centre line, two light sources in the central 300 m of the centre line and three light sources in the outer 300 m of the centre line to provide distance information; or
    - (II) A barrette.
  - (B) Where the serviceability level of the approach lights specified as a maintenance objective in § 139.1009- (10) can be demonstrated, each centre line light position may consist of either:
    - (I) A single light source; or
    - (II) A barrette.
  - (C) The barrettes must be at least 4 m in length. When barrettes are composed of lights approximating to point sources, the lights must be uniformly spaced at intervals of not more than 1.5 m.

---

## GACAR PART 139 – CERTIFICATION, AUTHORIZATION AND OPERATION OF AERODROMES

---

- (D) If the centre line consists of barrettes as described in 139.505-(d)-(3) -(ii) -(A) - (II) or 139.505-(d)-(3)-(ii)-(B)-(II), each barrette must be supplemented by a flashing light, except where such lighting is considered unnecessary taking into account the characteristics of the system and the nature of the meteorological conditions.
  - (E) Each flashing light as described in 139.505-(d)-(3)-(ii)-(D) must be flashed twice a second in sequence, beginning with the outermost light and progressing toward the threshold to the innermost light of the system. The design of the electrical circuit must be such that these lights can be operated independently of the other lights of the approach lighting system.
  - (F) If the centre line consists of lights as described in § 139.505-(d)-(3) -(ii) -(A) - (I) or § 139.505-(d)-(3) -(ii) -(B) -(I), additional crossbars of lights to the crossbar provided at 300 m from the threshold must be provided at 150 m, 450 m, 600 m and 750 m from the threshold. The lights forming each crossbar must be as nearly as practicable in a horizontal straight line at right angles to, and bisected by, the line of the centre line lights. The lights must be spaced so as to produce a linear effect, except that gaps may be left on each side of the centre line. These gaps must be kept to a minimum to meet local requirements and each must not exceed 6 m.
  - (G) Where the additional crossbars described in § 139.505-(d)-(3)- (ii)-(F) are incorporated in the system, the outer ends of the crossbars must lie on two straight lines that either are parallel to the line of the centre line lights or converge to meet the runway centre line 300 m from threshold.
  - (H) The lights must be in accordance with the specifications of Appendix H, Figure AH-6.
- (4) Precision approach category II and III lighting system
- (i) Location
    - (A) The approach lighting system must consist of a row of lights on the extended centre line of the runway, extending, wherever possible, over a distance of 900 m from the runway threshold. In addition, the system must have two side rows of lights, extending 270 m from the threshold, and two crossbars, one at 150 m and one at 300 m from the threshold, all as shown in Figure H-14. Where the serviceability level of the approach lights specified as maintenance objectives in § 139.1009- (7) can be demonstrated, the system may have two side rows of lights, extending 240 m from the threshold, and two crossbars, one at 150 m and one at 300 m from the threshold, all as shown in Figure H-15.
    - (B) The lights forming the centre line must be placed at longitudinal intervals of 30 m with the innermost lights located 30 m from the threshold.
    - (C) The lights forming the side rows must be placed on each side of the centre line, at a longitudinal spacing equal to that of the centre line lights and with the first



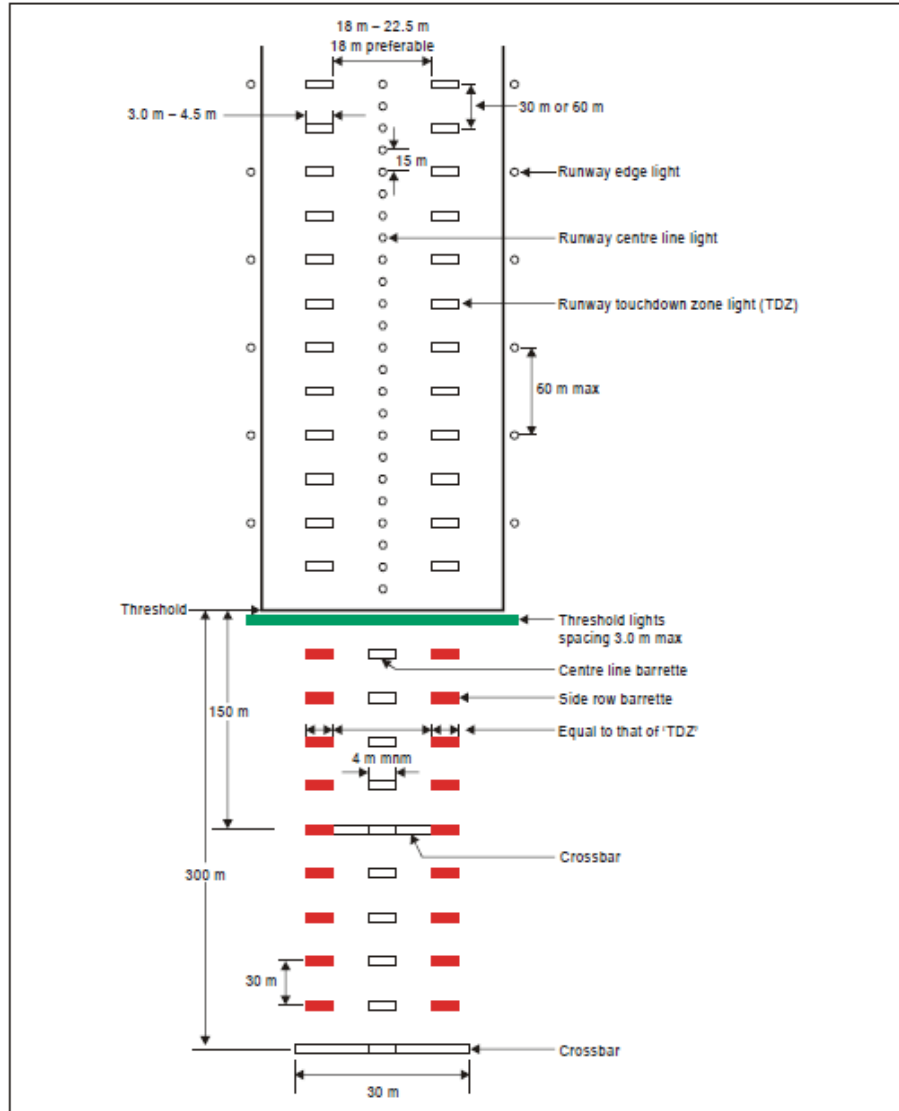
---

## **GACAR PART 139 – CERTIFICATION, AUTHORIZATION AND OPERATION OF AERODROMES**

---

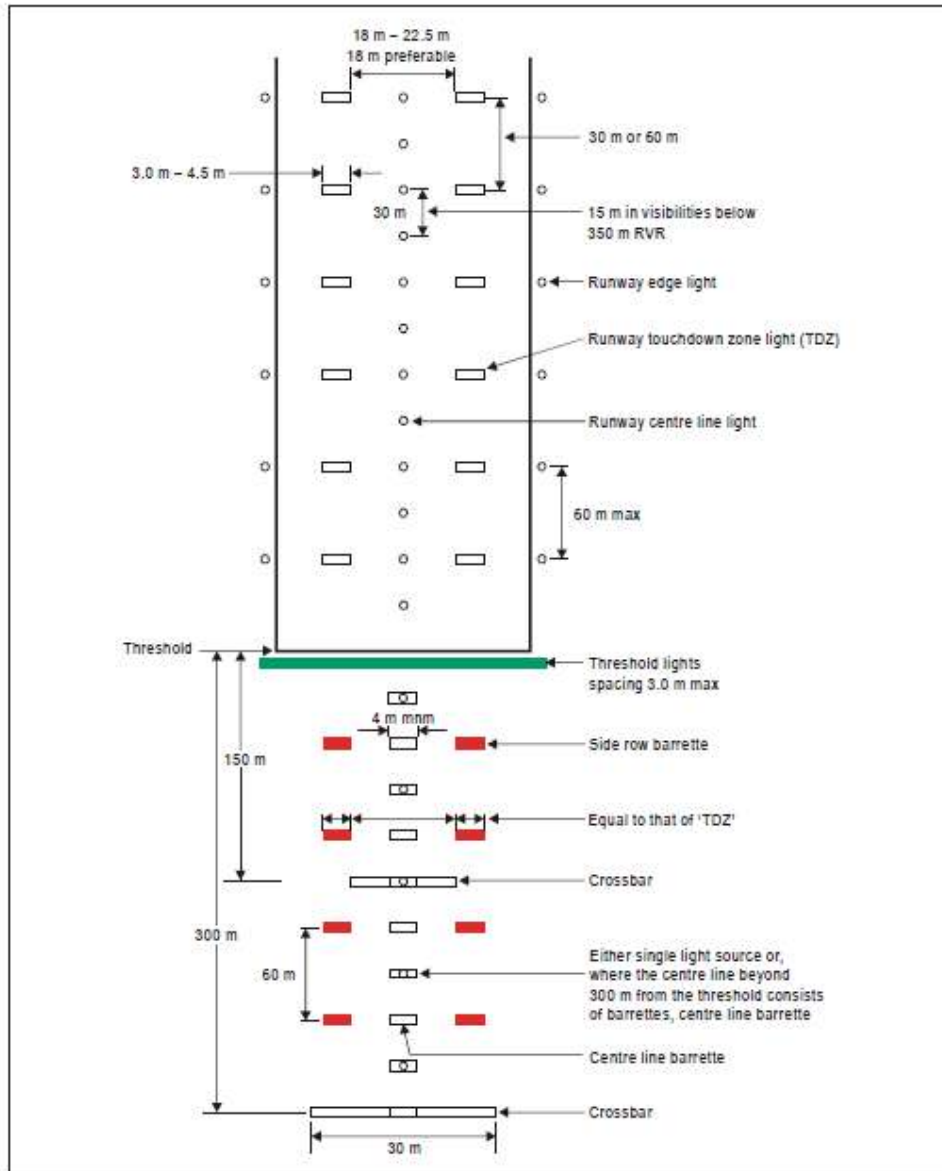
- light located 30 m from the threshold. Where the serviceability level of the approach lights specified as maintenance objectives in § 139.1009- (7) can be demonstrated, lights forming the side rows may be placed on each side of the centre line, at a longitudinal spacing of 60 m with the first light located 60 m from the threshold. The lateral spacing (or gauge) between the innermost lights of the side rows must be not less than 18 m nor more than 22.5 m, and preferably 18 m, but in any event must be equal to that of the touchdown zone lights.
- (D) The crossbar provided at 150 m from the threshold must fill in the gaps between the centre line and side row lights.
  - (E) The crossbar provided at 300 m from the threshold must extend on both sides of the centre line lights to a distance of 15 m from the centre line.
  - (F) If the centre line beyond a distance of 300 m from the threshold consists of lights as described in § 139.505-(d)-(4) -(ii) -(B) -(II) or § 139.505-(d)-(4) -(ii) -(C) -(II), additional crossbars of lights must be provided at 450 m, 600 m and 750 m from the threshold.
  - (G) Where the additional crossbars described in §139.505-(d) -(4)-(ii)-(F) are incorporated in the system, the outer ends of these crossbars must lie on two straight lines that either are parallel to the centre line or converge to meet the runway centre line 300 m from the threshold.
  - (H) The system must lie as nearly as practicable in the horizontal plane passing through the threshold, provided that:
    - (I) No object other than an ILS or MLS azimuth antenna must protrude through the plane of the approach lights within a distance of 60 m from the centre line of the system; and
    - (II) No light other than a light located within the central part of a crossbar or a centre line barrette (not their extremities) must be screened from an approaching aircraft. Any ILS or MLS azimuth antenna protruding through the plane of the lights must be treated as an obstacle and marked and lighted accordingly.

## GACAR PART 139 – CERTIFICATION, AUTHORIZATION AND OPERATION OF AERODROMES



**Figure H-14. Inner 300m approach and runway lighting for a precision approach runway, Categories II and III.**

## GACAR PART 139 – CERTIFICATION, AUTHORIZATION AND OPERATION OF AERODROMES



**Figure H-15. Inner 300m approach and runway lighting for a precision approach runway, Categories II and III, where the serviceability levels of the lights specified as maintenance objective in Subpart M can be demonstrated.**

---

## GACAR PART 139 – CERTIFICATION, AUTHORIZATION AND OPERATION OF AERODROMES

---

- (ii) Characteristics
- (A) The centre line of a precision approach category II and III lighting system for the first 300 m from the threshold must consist of barrettes showing variable white, except that, where the threshold is displaced 300 m or more, the centre line may consist of single light sources showing variable white. Where the serviceability level of the approach lights specified as maintenance objectives in § 139.1009- (7) can be demonstrated, the centre line of a precision approach category II and III lighting system for the first 300 m from the threshold may consist of either:
- (I) Barrettes, where the centre line beyond 300 m from the threshold consists of barrettes as described in § 139.505-(d)-(4)-(ii)-(C)-(II) or
- (II) Alternate single light sources and barrettes, where the centre line beyond 300 m from the threshold consists of single light sources as described in § 139.505-(d)-(4) -(ii)- (C)- (I), with the innermost single light source located 30 m and the innermost barrette located 60 m from the threshold; or
- (III) Single light sources where the threshold is displaced 300 m or more; all of which must show variable white.
- (B) Beyond 300 m from the threshold each centre line light position must consist of either:
- (I) A barrette as used on the inner 300 m; or
- (II) Two light sources in the central 300 m of the centre line and three light sources in the outer 300 m of the centre line; all of which must show variable white.
- (C) Where the serviceability level of the approach lights specified as maintenance objectives in § 139.1009- (7) can be demonstrated, beyond 300 m from the threshold each centre line light position may consist of either:
- (I) A barrette; or
- (II) A single light source; all of which must show variable white.
- (D) The barrettes must be at least 4 m in length. When barrettes are composed of lights approximating to point sources, the lights must be uniformly spaced at intervals of not more than 1.5 m.
- (E) If the centre line beyond 300 m from the threshold consists of barrettes as described in § 139.505-(d)-(4) - (ii) - (B) - (I) or § 139.505-(d)-(4) - (ii) -(C) - (I) each barrette beyond 300 m must be supplemented by a flashing light, except

---

## **GACAR PART 139 – CERTIFICATION, AUTHORIZATION AND OPERATION OF AERODROMES**

---

where such lighting is considered unnecessary taking into account the characteristics of the system and the nature of the meteorological conditions.

- (F) Each capacitor discharge light must be flashed twice a second in sequence, beginning with the outermost light and progressing toward the threshold to the innermost light of the system. The design of the electrical circuit must be such that these lights can be operated independently of the other lights of the approach lighting system.
- (G) The side row must consist of barrettes showing red. The length of a side row barrette and the spacing of its lights must be equal to those of the touchdown zone light barrettes.
- (H) The lights forming the crossbars must be fixed lights showing variable white. The lights must be uniformly spaced at intervals of not more than 2.7 m.
- (I) The intensity of the red lights must be compatible with the intensity of the white lights.
- (J) The lights must be in accordance with the specifications of Appendix H, Figures AH-6 and AH-7.

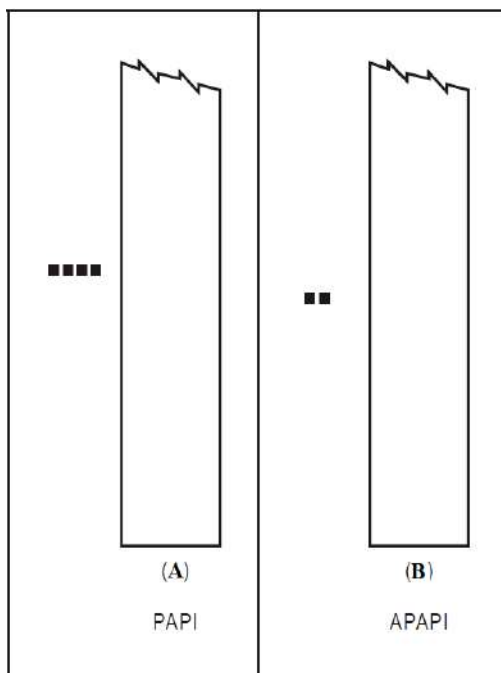
### (e) Visual approach slope indicator systems

#### (1) Application

- (i) A visual approach slope indicator system must be provided to serve the approach to a runway whether or not the runway is served by other visual approach aids or by non-visual aids, where one or more of the following conditions exist:
  - (A) The runway is used by turbojet or other aeroplanes with similar approach guidance requirements;
  - (B) The pilot of any type of aeroplane may have difficulty in judging the approach due to:
    - (I) Inadequate visual guidance such as is experienced during an approach over water or featureless terrain by day or in the absence of sufficient extraneous lights in the approach area by night, or
    - (II) Misleading information such as is produced by deceptive surrounding terrain or runway slopes;
  - (C) The presence of objects in the approach area may involve serious hazard if an Aeroplane descends below the normal approach path, particularly if there are no non-visual or other visual aids to give warning of such objects;
  - (D) Physical conditions at either end of the runway present a serious hazard in the event of an aeroplane undershooting or overrunning the runway; and

## GACAR PART 139 – CERTIFICATION, AUTHORIZATION AND OPERATION OF AERODROMES

- (E) Terrain or prevalent meteorological conditions are such that the aeroplane may be subjected to unusual turbulence during approach.



**Figure H-16. Visual approach slope indicator systems**

- (ii) The standard visual approach slope indicator systems must consist of PAPI and APAPI systems conforming to the specifications contained in § 139.505-(e)-(2) - (i) -(A) to § 139.505-(e)-(4) -(iv) -(F) inclusive; as shown in Figure H-16.
  - (iii) PAPI, must be provided where the code number is 3 or 4 when one or more of the conditions specified in § 139.505-(e)-(1)-(i) exist.
  - (iv) PAPI or APAPI must be provided where the code number is 1 or 2 when one or more of the conditions specified in § 139.505-(e)-(1) – (i) exist.
  - (v) Where a runway threshold is temporarily displaced from the normal position and one or more of the conditions specified in § 139.505-(e)-(1) -(i) exist, a PAPI must be provided except that where the code number is 1 or 2 an APAPI may be provided.
- (2) PAPI and APAPI
- (i) Description

---

## **GACAR PART 139 – CERTIFICATION, AUTHORIZATION AND OPERATION OF AERODROMES**

---

- (A) The PAPI system must consist of a wing bar of 4 sharp transition multi-lamp (or paired single lamp) units equally spaced. The system must be located on the left side of the runway unless it is physically impracticable to do so.
- (B) The APAPI system must consist of a wing bar of 2 sharp transition multi-lamp (or paired single lamp) units. The system must be located on the left side of the runway unless it is physically impracticable to do so.
- (C) The wing bar of a PAPI must be constructed and arranged in such a manner that a pilot making an approach will:
  - (I) When on or close to the approach slope, see the two units nearest the runway as red and the two units farthest from the runway as white;
  - (II) When above the approach slope, see the one unit nearest the runway as red and the three units farthest from the runway as white; and when further above the approach slope, see all the units as white; and
  - (III) When below the approach slope, see the three units nearest the runway as red and the unit farthest from the runway as white; and when further below the approach slope, see all the units as red.
- (D) The wing bar of an APAPI must be constructed and arranged in such a manner that a pilot making an approach will:
  - (I) When on or close to the approach slope, see the unit nearer the runway as red and the unit farther from the runway as white;
  - (II) When above the approach slope, see both the units as white; and
  - (III) When below the approach slope, see both the units as red.
- (ii) Siting

The light units must be located as in the basic configuration illustrated in Figure H-17, subject to the installation tolerances given therein. The units forming a wing bar must be mounted so as to appear to the pilot of an approaching aeroplane to be substantially in a horizontal line. The light units must be mounted as low as possible and must be frangible.
- (iii) Characteristics of the light units
  - (A) The system must be suitable for both day and night operations.

---

## GACAR PART 139 – CERTIFICATION, AUTHORIZATION AND OPERATION OF AERODROMES

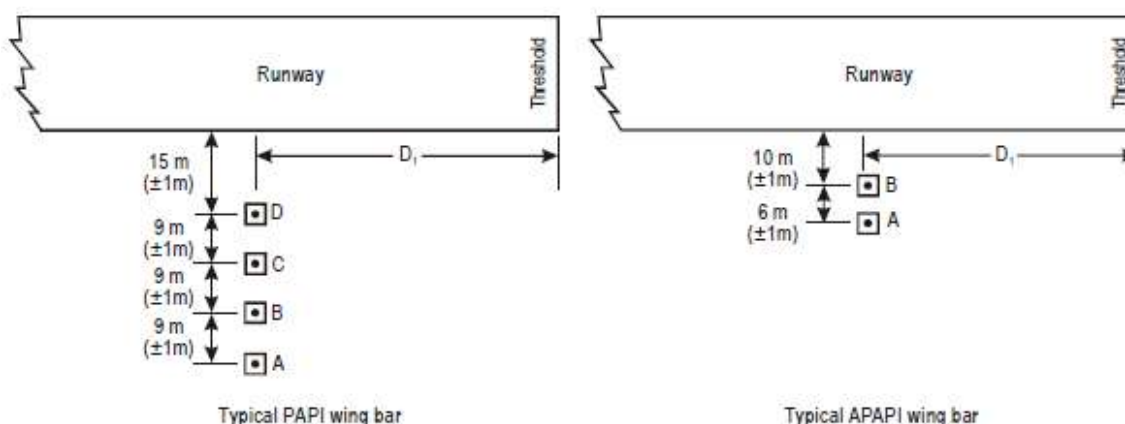
---

- (B) The color transition from red to white in the vertical plane must be such as to appear to an observer, at a distance of not less than 300 m, to occur within a vertical angle of not more than 3'.
  - (C) At full intensity red light must have a Y coordinate not exceeding 0.320.
  - (D) The light intensity distribution of the light units must be as shown in Appendix H, Figure AH-27.
  - (E) Suitable intensity control must be provided so as to allow adjustment to meet the prevailing conditions and to avoid dazzling the pilot during approach and landing.
  - (F) Each light unit must be capable of adjustment in elevation so that the lower limit of the white part of the beam may be fixed at any desired angle of elevation between 1°30' and at least 4°30' above the horizontal.
  - (G) The light units must be so designed that deposits of condensation, snow, ice, dirt, etc., on optically transmitting or reflecting surfaces must interfere to the least possible extent with the light signals and must not affect the contrast between the red and white signals and the elevation of the transition sector.
- (iv) Approach slope and elevation setting of light units
- (A) The approach slope as defined in Figure H-18 must be appropriate for use by the aeroplanes using the approach.
  - (B) When the runway is equipped with an ILS and/or MLS, the siting and the angle of elevation of the light units must be such that the visual approach slope conforms as closely as possible to the glide path of the ILS and/or the minimum glide path of the MLS, as appropriate.
  - (C) The angle of elevation settings of the light units in a PAPI wing bar must be such that, during an approach, the pilot of an aeroplane observing a signal of one white and three reds will clear all objects in the approach area by a safe margin (See Table H-2).
  - (D) The angle of elevation settings of the light units in an APAPI wing bar must be such that, during an approach, the pilot of an aeroplane observing the lowest on slope signal, i.e. one white and one red, will clear all objects in the approach area by a safe margin (See Table H-2).
  - (E) The azimuth spread of the light beam must be suitably restricted where an object located outside the obstacle protection surface of the PAPI or APAPI system, but within the lateral limits of its light beam, is found to extend above the plane of the obstacle protection surface and an aeronautical study indicates that the object could adversely affect the safety of operations. The extent of the restriction must be such that the object remains outside the confines of the light beam.



## GACAR PART 139 – CERTIFICATION, AUTHORIZATION AND OPERATION OF AERODROMES

- (F) Where wing bars are installed on each side of the runway to provide roll guidance, corresponding units must be set at the same angle so that the signals of each wing bar change symmetrically at the same time.



### INSTALLATION TOLERANCES

- a) Where a PAPI or APAPI is installed on a runway not equipped with ILS or MLS, the distance  $D_1$  must be calculated to ensure that the lowest height at which a pilot will see a correct approach path indication (Figure H-18, angle B for a PAPI and angle A for an APAPI) provides the wheel clearance over the threshold specified in Table E-2 for the most demanding amongst aeroplanes regularly using the runway.

Note. See Section § 139.503-(e) for specifications on aiming point marking.

b) Where a PAPI or APAPI is installed on a runway equipped with an ILS and/or MLS, the distance  $D_1$  must be calculated to provide the optimum compatibility between the visual and non-visual aids for the range of eye-to-antenna heights of the aeroplanes regularly using the runway. The distance must be equal to that between the threshold and the effective origin of the ILS glide path or MLS minimum glide path, as appropriate, plus a correction factor for the variation of eye-to-antenna heights of the aeroplanes concerned. The correction factor is obtained by multiplying the average eye-

## GACAR PART 139 – CERTIFICATION, AUTHORIZATION AND OPERATION OF AERODROMES

|  |  |
|--|--|
| <p>c) If the wheel clearance, greater than that specified in a) above is required for specific aircraft, this can be achieved by increasing D1.</p> <p>d) Distance D1 must be adjusted to compensate for differences in elevation between the lens centres of the light units and the threshold.</p> <p>e) To ensure that units are mounted as low as possible and to allow for any transverse slope, small height adjustment of up to 5 cm between units are acceptable. A lateral gradient not greater than 1.25 per cent can be accepted provided it is uniformly applied across the units.</p> | <p>to-antenna height of those aeroplanes by the cotangent the approach angle. However, the distance must be such that in no case will the wheel clearance over the threshold be lower than the specific in column (3) of Table E-2.</p> <p>f) A spacing of 6m (+/-1m) between PAPI units must be used on code numbers 1 and 2. In such an event, the inner PAPI unit must be located not less than 10m (+/- 1m) from the runway edge.</p> <p>Note. Reducing the spacing between light units results in a reduction in usability of the system.</p> <p>The lateral spacing between PAPI units may be increased to 9m (+/- 1m) if a greater range is required or later conversion to a full PAPI is anticipated. In a letter case, the inner APAPI unit must be located 15m (+/- 1m) from the runway edge.</p> |
|--|--|

**Figure H-17. Siting of PAPI and APAPI**

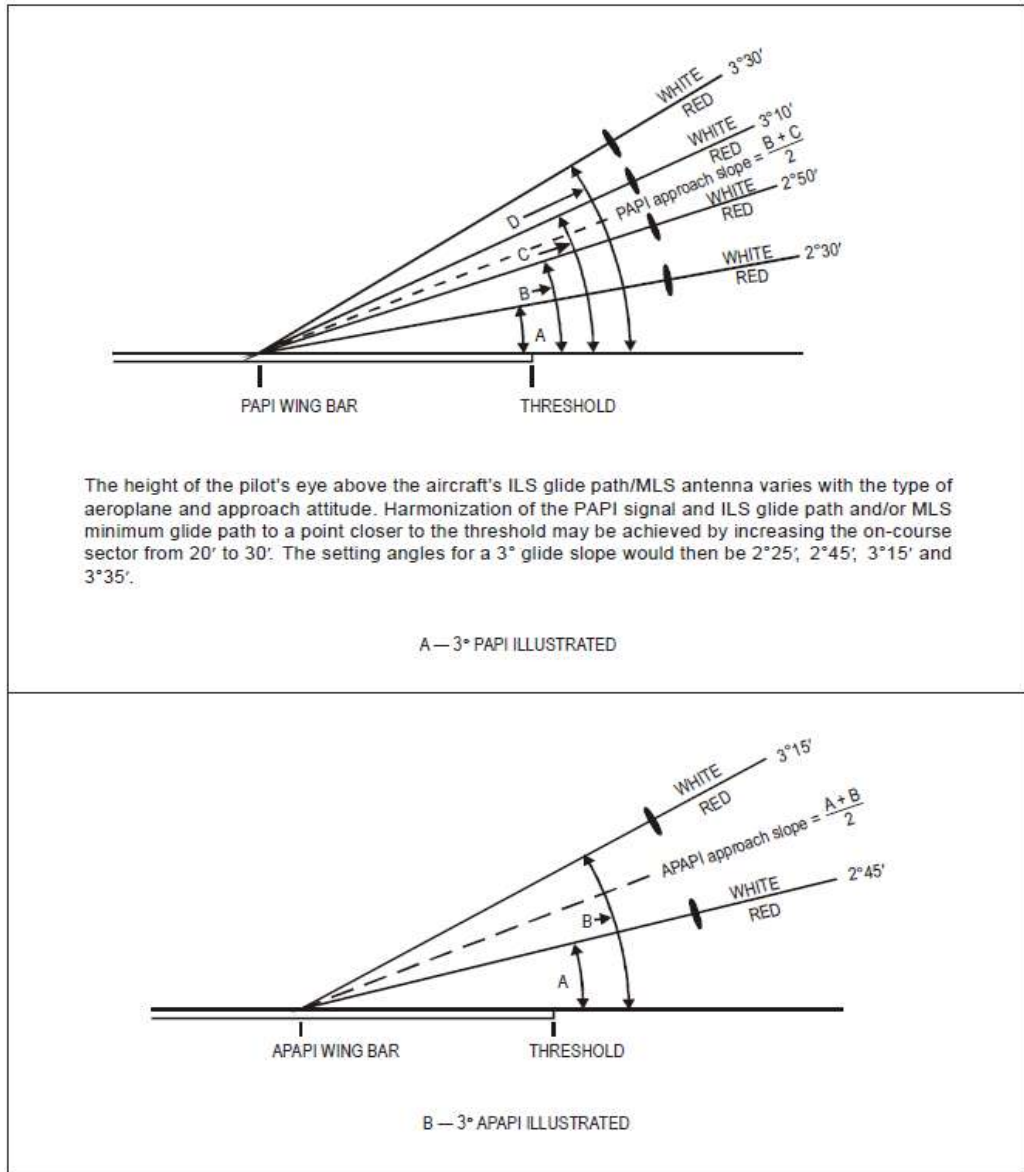
- (v) Obstacle protection surface
  - (A) An obstacle protection surface must be established when it is intended to provide a visual approach slope indicator system.
  - (B) The characteristics of the obstacle protection surface, i.e. origin, divergence, length and slope must correspond to those specified in the relevant column of Table H-3 and in Figure H-19.
  - (C) New objects or extensions of existing objects must not be permitted above an obstacle protection surface except when, in the opinion of the President, the new object or extension would be shielded by an existing immovable object.
  - (D) Existing objects above an obstacle protection surface must be removed except when, in the opinion of the President, the object is shielded by an existing immovable object, or after aeronautical study it is determined that the object would not adversely affect the safety of operations of aeroplanes.

**GACAR PART 139 – CERTIFICATION, AUTHORIZATION AND OPERATION OF  
AERODROMES**

---

- (E) Where an aeronautical study indicates that an existing object extending above an obstacle protection surface could adversely affect the safety of operations of aeroplanes one or more of the following measures must be taken:
- (I) Remove the object;
  - (II) Suitably raise the approach slope of the system;
  - (III) Reduce the azimuth spread of the system so that the object is outside the confines of the beam;
  - (IV) Displace the axis of the system and its associated obstacle protection surface by no more than 5°;
  - (V) Suitably displace the system upwind of the threshold such that the object no longer penetrates the OPS.

## GACAR PART 139 – CERTIFICATION, AUTHORIZATION AND OPERATION OF AERODROMES



**Figure H-18. Light beams and angle of elevation setting of PAPI and APAPI.**

## GACAR PART 139 – CERTIFICATION, AUTHORIZATION AND OPERATION OF AERODROMES

| Eye-to-wheel height of aeroplane<br>in the approach configuration <sup>a</sup> | Desired wheel clearance<br>(metres) <sup>b,c</sup> | Minimum wheel clearance<br>(metres) <sup>d</sup> |
|--|--|--|
| (1)  | (2)  | (3)  |
| up to but not including 3 m  | 6  | 3 <sup>e</sup>                                   |
| 3 m up to but not including 5 m  | 9  | 4  |
| 5 m up to but not including 8 m  | 9  | 5  |
| 8 m up to but not including 14 m   | 9  | 6  |

a. In selecting the eye-to-wheel height group, only aeroplanes meant to use the system on a regular basis shall be considered. The most demanding amongst such aeroplanes shall determine the eye-to-wheel height group.  
 b. Where practicable the desired wheel clearances shown in column (2) shall be provided.  
 c. The wheel clearances in column (2) may be reduced to no less than those in column (3) where an aeronautical study indicates that such reduced wheel clearances are acceptable.  
 d. When a reduced wheel clearance is provided at a displaced threshold it shall be ensured that the corresponding desired wheel clearance specified in column (2) will be available when an aeroplane at the top end of the eye-to-wheel height group chosen overflies the extremity of the runway.  
 e. This wheel clearance may be reduced to 1.5 m on runways used mainly by light-weight non-turbojet aeroplanes.

**Table H-2. Wheel clearance over threshold for PAPI and APAPI**

## GACAR PART 139 – CERTIFICATION, AUTHORIZATION AND OPERATION OF AERODROMES

| Surface dimensions  | Runway type/code number       |                      |                      |                      |                           |                      |                      |                      |
|---|-------------------------------|----------------------|----------------------|----------------------|---------------------------|----------------------|----------------------|----------------------|
|   | Non-instrument<br>Code number |                      |                      |                      | Instrument<br>Code number |                      |                      |                      |
|   | 1                             | 2                    | 3                    | 4                    | 1                         | 2                    | 3                    | 4                    |
| Length of inner edge  | 60 m                          | 80 m                 | 150 m                | 150 m                | 150 m                     | 150 m                | 300 m                | 300 m                |
| Distance from the visual approach slope indicator system <sup>c</sup> | D <sub>1</sub> +30 m          | D <sub>1</sub> +60 m | D <sub>1</sub> +60 m | D <sub>1</sub> +60 m | D <sub>1</sub> +60 m      | D <sub>1</sub> +60 m | D <sub>1</sub> +60 m | D <sub>1</sub> +60 m |
| Divergence (each side)  | 10%                           | 10%                  | 10%                  | 10%                  | 15%                       | 15%                  | 15%                  | 15%                  |
| Total length  | 7 500 m                       | 7 500 m              | 15 000 m             | 15 000 m             | 7 500 m                   | 7 500 m              | 15 000 m             | 15 000 m             |
| <i>Slope</i>  |                               |                      |                      |                      |                           |                      |                      |                      |
| a) PAPI <sup>b</sup>  | –                             | A–0.57°              | A–0.57°              | A–0.57°              | A–0.57°                   | A–0.57°              | A–0.57°              | A–0.57°              |
| b) APAPI <sup>b</sup>   | A–0.9°                        | A–0.9°               | –                    | –                    | A–0.9°                    | A–0.9°               | –                    | –                    |

a. No slope has been specified if a system is unlikely to be used on runway type/code number indicated.  
b. Angles as indicated in Figure E-18  
c. D<sub>1</sub> is the distance of the visual approach slope indicator system from threshold prior to any displacement to remedy object penetration of the OPS (refer Figure E-17). The start of the OPS is fixed to the visual approach slope indicator system location, such that displacement of the PAPI results in an equal displacement of the start of the OPS. See 139.505(e) (2) (v) (E)(V)

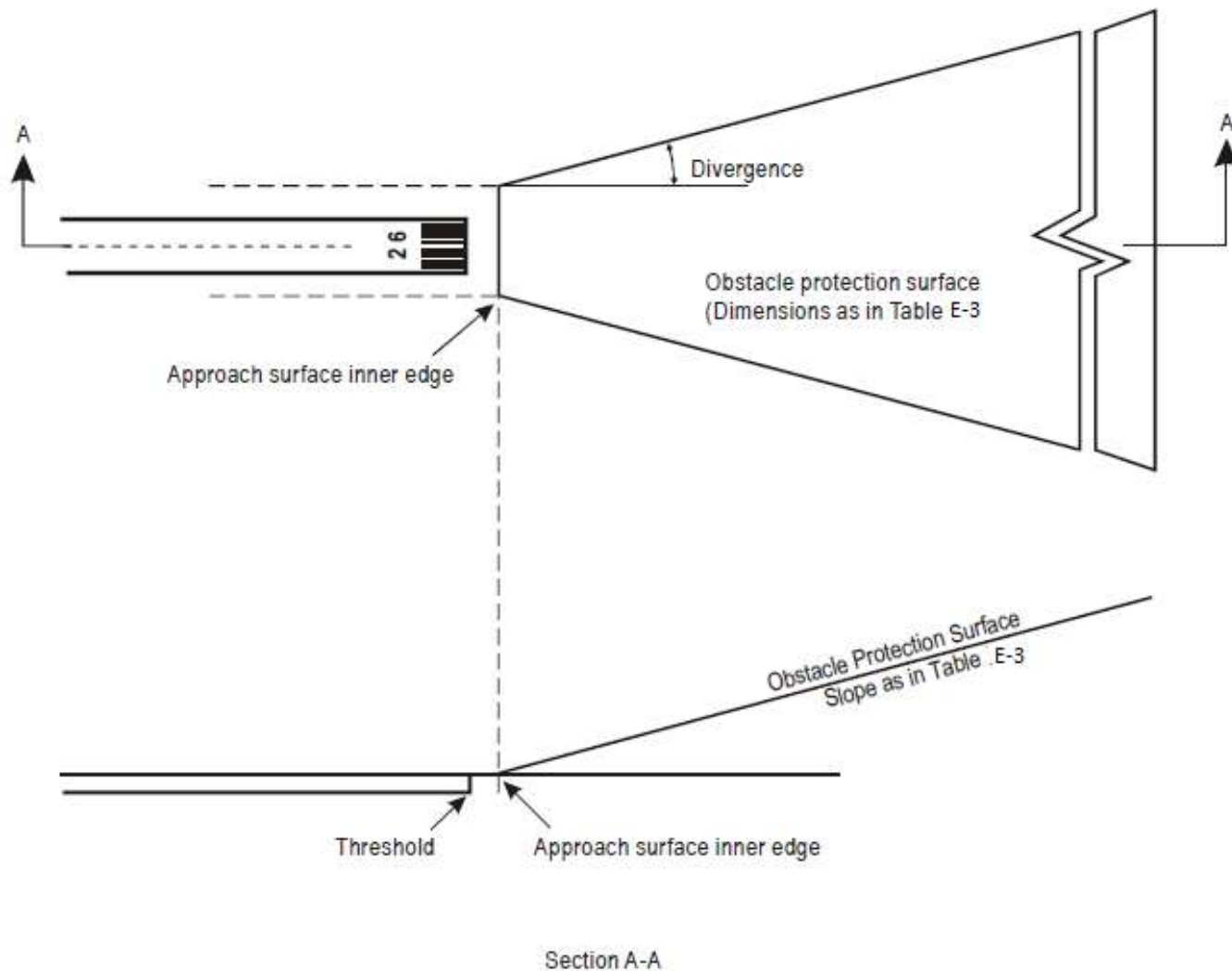
**Table H-3. Dimension and Slopes of the obstacle protection surface**

(f) Circling guidance lights

(1) Application

Circling guidance lights must be provided when existing approach and runway lighting systems do not satisfactorily permit identification of the runway and/or approach area to a circling aircraft in the conditions for which it is intended the runway be used for circling approaches.

## GACAR PART 139 – CERTIFICATION, AUTHORIZATION AND OPERATION OF AERODROMES



**Figure H-19. Obstacles protection surface for visual approach slop indicator systems**

- (2) Location
  - (i) The location and number of circling guidance lights must be adequate to enable a pilot, as appropriate, to:
    - (A) Join the downwind leg or align and adjust the aircraft's track to the runway at a required distance from it and to distinguish the threshold in passing; and

---

## **GACAR PART 139 – CERTIFICATION, AUTHORIZATION AND OPERATION OF AERODROMES**

---

- (B) Keep in sight the runway threshold and/or other features which will make it possible to judge the turn on to base leg and final approach, taking into account the guidance provided by other visual aids.
- (ii) Circling guidance lights must consist of:
  - (A) Lights indicating the extended centre line of the runway and/or parts of any approach lighting system; or
  - (B) Lights indicating the position of the runway threshold; or
  - (C) Lights indicating the direction or location of the runway;
  - (D) Or a combination of such lights as is appropriate to the runway under consideration.
- (3) Characteristics
  - (i) Circling guidance lights must be fixed or flashing lights of an intensity and beam spread adequate for the conditions of visibility and ambient light in which it is intended to make visual circling approaches. The flashing lights must be white, and the steady lights either white or gaseous discharge lights.
  - (ii) The lights must be designed and be installed in such a manner that they will not dazzle or confuse a pilot when approaching to land, taking off or taxiing.
- (g) Runway threshold identification lights
  - (1) Application

Runway threshold identification lights must be installed:

    - (i) At the threshold of a non-precision approach runway when additional threshold conspicuity is necessary or where it is not practicable to provide other approach lighting aids; and
    - (ii) Where a runway threshold is permanently displaced from the runway extremity or temporarily displaced from the normal position and additional threshold conspicuity is necessary.
  - (2) Location

Runway threshold identification lights must be located symmetrically about the runway centre line, in line with the threshold and approximately 10 m outside each line of runway edge lights.
  - (3) Characteristics
    - (i) Runway threshold identification lights must be flashing white lights with a flash frequency between 60 and 120 per minute.
    - (ii) The lights must be visible only in the direction of approach to the runway.
- (h) Runway edge lights
  - (1) Application



---

## GACAR PART 139 – CERTIFICATION, AUTHORIZATION AND OPERATION OF AERODROMES

---

- (i) Runway edge lights must be provided for a runway intended for use at night or for a precision approach runway intended for use by day or night.
  - (ii) Runway edge lights must be provided on a runway intended for take-off with an operating minimum below an RVR of the order of 800 m by day.
  - (2) Location
    - (i) Runway edge lights must be placed along the full length of the runway and must be in two parallel rows equidistant from the centre line.
    - (ii) Runway edge lights must be placed along the edges of the area declared for use as the runway or outside the edges of the area at a distance of not more than 3 m.
    - (iii) The lights must be uniformly spaced in rows at intervals of not more than 60 m for an instrument runway, and at intervals of not more than 100 m for a non-instrument runway. The lights on opposite sides of the runway axis must be on lines at right angles to that axis. At intersections of runways, lights may be spaced irregularly or omitted, provided that adequate guidance remains available to the pilot.
  - (3) Characteristics
    - (i) Runway edge lights must be fixed lights showing variable white, except that:
      - (A) In the case of a displaced threshold, the lights between the beginning of the runway and the displaced threshold must show red in the approach direction; and
      - (B) A section of the lights 600 m or one-third of the runway length, whichever is the less, at the remote end of the runway from the end at which the take-off run is started, may show yellow.
    - (ii) The runway edge lights must show at all angles in azimuth necessary to provide guidance to a pilot landing or taking off in either direction. When the runway edge lights are intended to provide circling guidance, they must show at all angles in azimuth (see § 139.505-(f)-(1)).
    - (iii) In all angles of azimuth required in § 139.505-(h)-(3) -(ii) runway edge lights must show at angles up to 15° above the horizontal with an intensity adequate for the conditions of visibility and ambient light in which use of the runway for take-off or landing is intended. In any case, the intensity must be at least 50 cd except that at an Aerodrome without extraneous lighting the intensity of the lights may be reduced to not less than 25 cd to avoid dazzling the pilot.
    - (iv) Runway edge lights on a precision approach runway must be in accordance with the specifications of Appendix H, Figure AH-14 or AH-15.
- (i) Runway threshold and wing bar lights (see Figure H-20A and Figure H-20B)
- (1) Application of runway threshold lights

---

## **GACAR PART 139 – CERTIFICATION, AUTHORIZATION AND OPERATION OF AERODROMES**

---

Runway threshold lights must be provided for a runway equipped with runway edge lights except on a non-instrument or non-precision approach runway where the threshold is displaced, and wing bar lights are provided.

- (i) Location of runway threshold lights
  - (A) When a threshold is at the extremity of a runway, the threshold lights must be placed in a row at right angles to the runway axis as near to the extremity of the runway as possible and, in any case, not more than 3 m outside the extremity.
  - (B) When a threshold is displaced from the extremity of a runway, threshold lights must be placed in a row at right angles to the runway axis at the displaced threshold.
  - (C) Threshold lighting must consist of:
    - (I) On a non-instrument or non-precision approach runway, at least six lights;
    - (II) On a precision approach runway category- I, at least the number of lights that would be required if the lights were uniformly spaced at intervals of 3 m between the rows of runway edge lights; and
    - (III) On a precision approach runway category- II or III, lights uniformly spaced between the rows of runway edge lights at intervals of not more than 3 m.
  - (D) The lights prescribed in (§ 139.505-(i)-(i)-(C)-(I) and (II) must be either:
    - (I) Equally spaced between the rows of runway edge lights, or
    - (II) Symmetrically disposed about the runway centre line in two groups, with the lights uniformly spaced in each group and with a gap between the groups equal to the gauge of the touchdown zone marking or lighting, where such is provided, or otherwise not more than half the distance between the rows of runway edge lights.

(2) Application of wing bar lights

Wing bar lights must be provided on a non-instrument or non-precision approach runway where the threshold is displaced and runway threshold lights are required but are not provided.

- (i) Location of wing bar lights

Wing bar lights must be symmetrically disposed about the runway centre line at the threshold in two groups, i.e., wing bars. Each wing bar must be formed by at least five lights extending at least 10 m outward from, and at right angles to, the line of the runway edge lights, with the innermost light of each wing bar in the line of the runway edge lights.

---

## GACAR PART 139 – CERTIFICATION, AUTHORIZATION AND OPERATION OF AERODROMES

---

- (3) Characteristics of runway threshold and wing bar lights
- (i) Runway threshold and wing bar lights must be fixed unidirectional lights showing green in the direction of approach to the runway. The intensity and beam spread of the lights must be adequate for the conditions of visibility and ambient light in which use of the runway is intended.
  - (ii) Runway threshold lights on a precision approach runway must be in accordance with the specifications of Appendix H, Figure AH-8.
  - (iii) Threshold wing bar lights on a precision approach runway must be in accordance with the specifications of Appendix H, Figure AH-9.

(j) Runway end lights

(1) Application

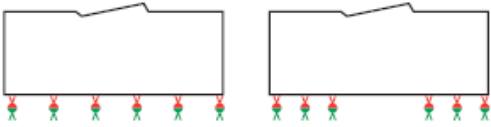

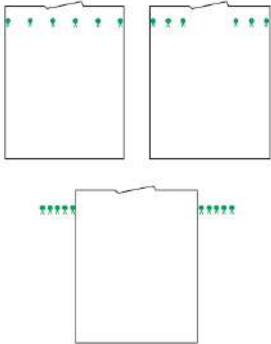
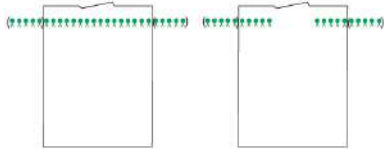

Runway end lights must be provided for a runway equipped with runway edge lights.

(2) Location

- (i) Runway end lights must be placed on a line at right angles to the runway axis as near to the end of the runway as possible and, in any case, not more than 3 m outside the end.
- (ii) Runway end lighting must consist of at least six lights. The lights must be either:
  - (A) Equally spaced between the rows of runway edge lights, or
  - (B) Symmetrically disposed about the runway centre line in two groups with the lights uniformly spaced in each group and with a gap between the groups of not more than half the distance between the rows of runway edge lights.


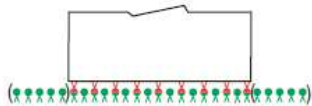
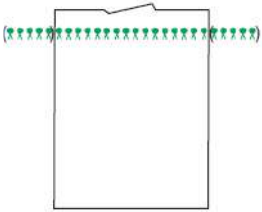
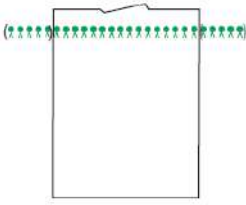

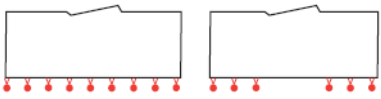
For a precision approach runway category III, the spacing between runway end lights, except between the two innermost lights if a gap is used, must not exceed 6 m. (see Figure H-20. A and Figure H-20. B)

**GACAR PART 139 – CERTIFICATION, AUTHORIZATION AND OPERATION OF AERODROMES**

| Conditions                                | Lights                            | Non-Instrument and Non-Precision Approach runway  | Precision approach runway Category I  |
|---|-----------------------------------|---|---|
| Threshold at runway extremity             | Runway threshold and runway light |  <p>§ 139.505-(i)-(1)-(i)-(A) , § 139.505-(i)-(1)-(i)-(C)-(I), § 139.505-(i)-(1)-(i)-(D), § 139.505-(j)-(2)-(i) , § 139.505-(j)-(2)-(ii)</p> |  <p>(139.505-(i)-(1)-(i)-(A), § 139.505-(i)-(1)-(i)-(C)-(II), § 139.505-(i)-(1)-(i)-(D), § 139.505-(i)-(2)-(i), § 139.505-(j)-(2)-(i), § 139.505-(j)-(2)(ii)</p> |
| Threshold displaced from runway extremity | Runway threshold light            |  <p>((§ 139.505-(i)-(1)-(i)-(B), § 139.505-(i)-(1)-(i)-(C)-(I) § 139.505-(i)-(1)-(i)-(D), § 139.505-(i)-(2)-(i))</p>                        |  <p>((§ 139.505-(i)-(1)-(i)-(B), § 139.505-(i)-(1)-(i)-(C)-(II), § 139.505-(i)-(1)-(i)-(D), § 139.505-(i)-(2)-(i))</p>   |
|   | Runway end light                  |  <p>(§ 139.505-(j)-(2)-(i), § 139.505-(j)-(2)-(ii)</p>  |   |

**Figure H-20.A. Arrangement for Runway threshold and runway end light. Case of Non-Instrument and Non-Precision Approach runway and case of Precision approach runway Category I.**

**GACAR PART 139 – CERTIFICATION, AUTHORIZATION AND OPERATION OF  
AERODROMES**

| Conditions                                | Lights                            | Precision approach runway Category II   | Precision approach runway Category III  |
|---|-----------------------------------|---|---|
| Threshold at runway extremity             | Runway threshold and runway light |  <p>(§ 139.505-(i)-(1)-(i)-(A), § 139.505-(i)-(1)-(i)-(C)-(III), § 139.505-(i)-(2)-(i); § 139.505-(j)-(2)-(i); § 139.505-(i)-(2)-(ii))</p> |  <p>(§ 139.505-(i)-(1)-(i)-(A), § 139.505-(i)-(1)-(i)-(C)-(III), § 139.505-(i)-(2)-(i); § 139.505-(j)-(2)-(i); § 139.505-(i)-(2)-(ii))</p> |
| Threshold displaced from runway extremity | Runway threshold light            |  <p>((§139.505-(i)-(1)-(i)-(B), § 139.505-(i)-(1)-(i)-(C)-(III), § 139.505-(i)-(2)-(i),))</p>   |  <p>((§139.505-(i)-(1)-(i)-(B), § 139.505-(i)-(1)-(i)-(C)-(III), § 139.505-(i)-(2)-(i),))</p>   |
|   | Runway end light                  |  <p>(§ 139.505-(j)-(2)-(i), § 139.505-(j)-(2)-(ii))</p>   |  <p>(§ 139.505-(j)-(2)-(i), § 139.505-(j)-(2)-(ii))</p>  |

**Figure H-20. B. Arrangement for Runway threshold and runway end light. Case of Precision approach runway Category II and case of Precision approach runway Category III**

- (3) Characteristics
  - (i) Runway end lights must be fixed unidirectional lights showing red in the direction of the runway. The intensity and beam spread of the lights must be adequate for the conditions of visibility and ambient light in which use of the runway is intended.

---

## GACAR PART 139 – CERTIFICATION, AUTHORIZATION AND OPERATION OF AERODROMES

---

- (ii) Runway end lights on a precision approach runway must be in accordance with the specifications of Appendix H, Figure AH-13.

### (k) Runway centre line lights

#### (1) Application

- (i) Runway centre line lights must be provided on a precision approach runway category II or III.
- (ii) Runway centre line lights must be provided on a runway intended to be used for take-off with an operating minimum below an RVR of the order of 400 m or higher when used by aeroplane with a very high take-off speed, particularly where the width between the runway edge lights is greater than 50 m.

#### (2) Location

- (i) Runway centre line lights must be located along the centre line of the runway, except that the lights may be uniformly offset to the same side of the runway centre line by not more than 60 cm where it is not practicable to locate them along the centre line. The lights must be located from the threshold to the end at longitudinal spacing of approximately 15 m. Where the serviceability level of the runway centre line lights specified as maintenance objectives in § 139.1009- (7) or § 139.1009- (11), as appropriate, can be demonstrated and the runway is intended for use in runway visual range conditions of 350 m or greater, the longitudinal spacing may be approximately 30 m.
- (ii) Centre line guidance for take-off from the beginning of a runway to a displaced threshold must be provided by:
  - (A) An approach lighting system if its characteristics and intensity settings afford the guidance required during take-off and it does not dazzle the pilot of an aircraft taking off; or
  - (B) Runway centre line lights; or
  - (C) Barrettes of at least 3 m length and spaced at uniform intervals of 30 m, as shown in Figure H-21), designed so that their photometric characteristics and intensity setting afford the guidance required during take-off without dazzling the pilot of an aircraft taking off.

Where necessary, provision must be made to extinguish those centre line lights specified in (B) or reset the intensity of the approach lighting system or barrettes when the runway is being used for landing. In no case must only the single source runway centre line lights show from the beginning of the runway to a displaced threshold when the runway is being used for landing.

---

## GACAR PART 139 – CERTIFICATION, AUTHORIZATION AND OPERATION OF AERODROMES

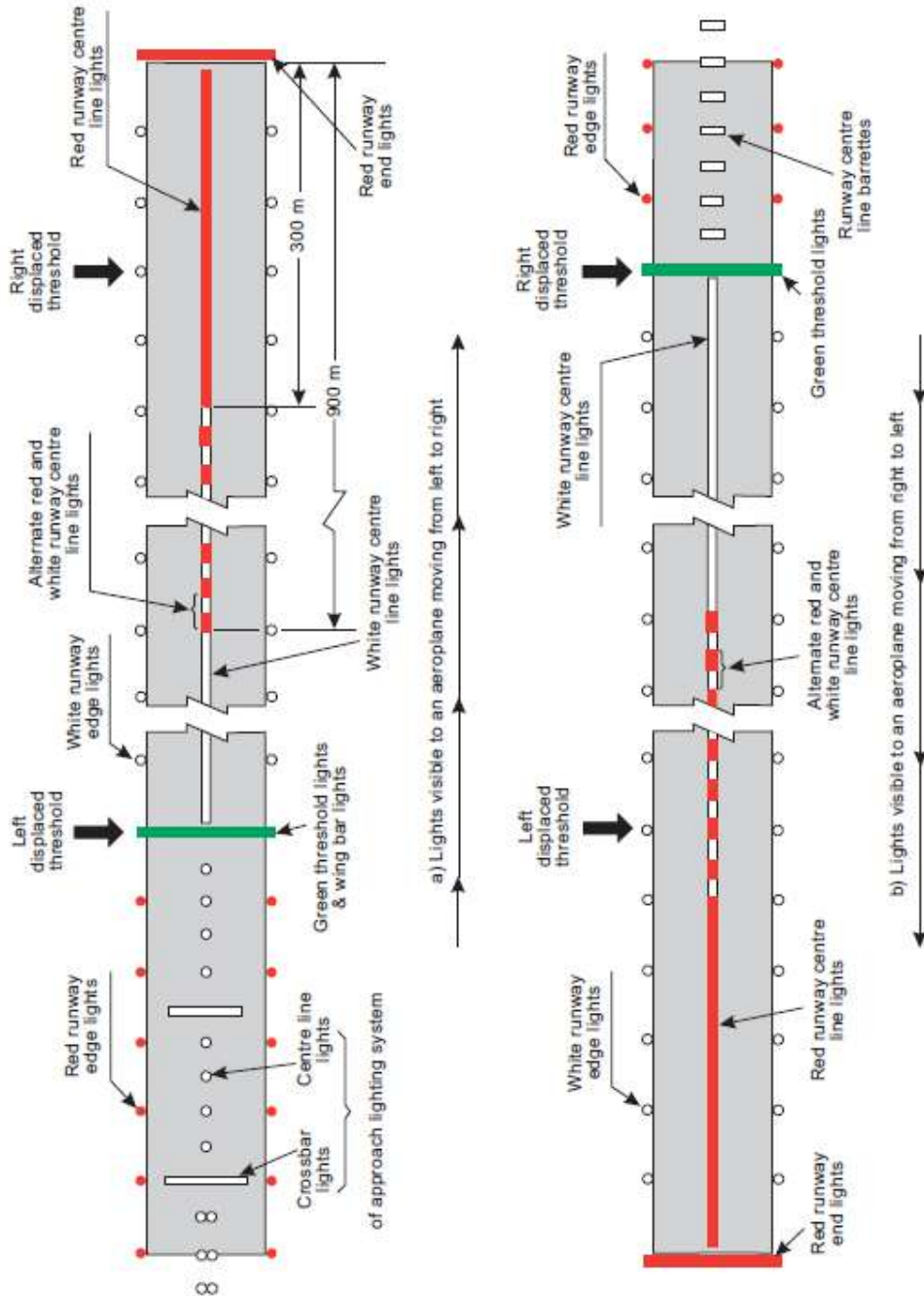
---

- (3) Characteristics
  - (i) Runway centre line lights must be fixed lights showing variable white from the threshold to the point 900 m from the runway end; alternate red and variable white from 900 m to 300 m from the runway end; and red from 300 m to the runway end, except that for runways less than 1,800 m in length, the alternate red and variable white lights must extend from the mid-point of the runway usable for landing to 300 m from the runway end.
  - (ii) Runway centre line lights must be in accordance with the specifications of Appendix H, Figure AH-11 or AH-12.
- (1) Runway touchdown zone lights
  - (1) Application

Touchdown zone (TDZ) lights must be provided in the touchdown zone of a precision approach runway category II or III.
  - (2) Location

Touchdown zone lights must extend from the threshold for a longitudinal distance of 900 m, except that, on runways less than 1,800 m in length, the system must be shortened so that it does not extend beyond the midpoint of the runway. The pattern must be formed by pairs of barrettes symmetrically located about the runway centre line. The lateral spacing between the innermost lights of a pair of barrettes must be equal to the lateral spacing selected for the touchdown zone marking. The longitudinal spacing between pairs of barrettes must be either 30 m or 60 m.
  - (3) Characteristics
    - (i) A barrette must be composed of at least three lights with a spacing between the lights of not more than 1.5 m.
    - (ii) Touchdown zone lights must be fixed unidirectional lights showing variable white.
    - (iii) Touchdown zone lights must be in accordance with the specifications of Appendix H, Figure AH-10.

## GACAR PART 139 – CERTIFICATION, AUTHORIZATION AND OPERATION OF AERODROMES



Example shows lighting on a runway having displaced thresholds at each end and a precision approach category I lighting system serving the left displaced threshold

**Figure H-21. Example of Approach and runway lighting for runway with displaced threshold.**



## GACAR PART 139 – CERTIFICATION, AUTHORIZATION AND OPERATION OF AERODROMES

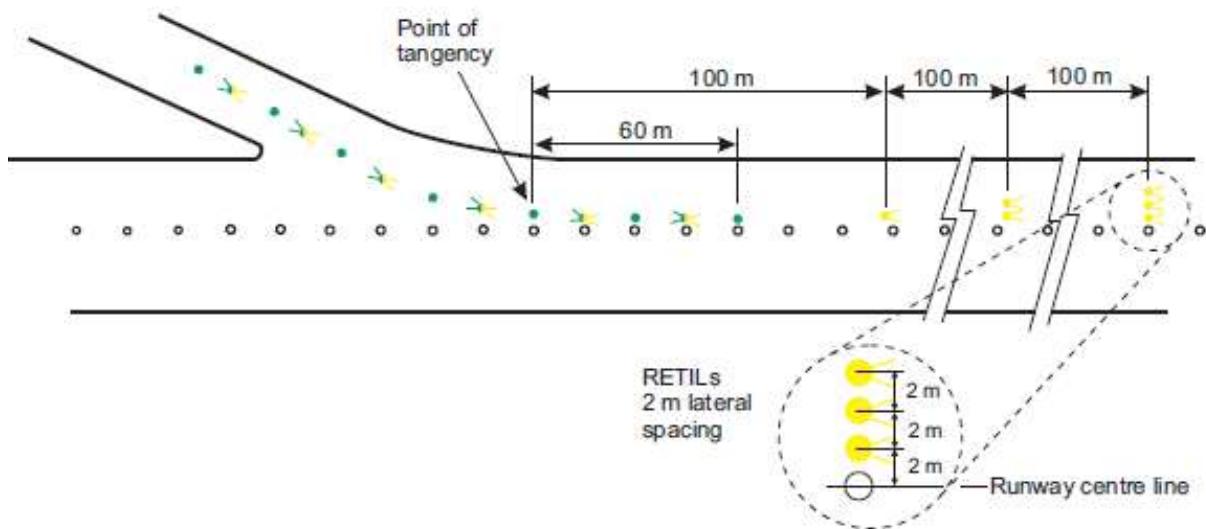
### (m) Rapid exit taxiway indicator lights

#### (1) Application

- (i) Rapid exit taxiway indicator lights must be provided on a runway intended for use in runway visual range conditions less than a value of 350 m and/or where the traffic density is heavy.
- (ii) Rapid exit taxiway indicator lights must not be displayed in the event of any lamp failure or other failure that prevents the display of the light pattern depicted in Figure H-22, in full.

#### (2) Location

- (i) A set of rapid exit taxiway indicator lights must be located on the runway on the same side of the runway centre line as the associated rapid exit taxiway, in the configuration shown in Figure H-22. In each set, the lights must be located 2 m apart and the light nearest to the runway centre line must be displaced 2 m from the runway centre line.
- (ii) Where more than one rapid exit taxiway exists on a runway, the set of rapid exit taxiway indicator lights for each exit must not overlap when displayed.



**Figure H-22. Rapid exit taxiway indicator light (RETILs)**

#### (3) Characteristics

- (i) Rapid exit taxiway indicator lights must be fixed unidirectional yellow lights, aligned so as to be visible to the pilot of a landing aeroplane in the direction of approach to the runway.

---

## GACAR PART 139 – CERTIFICATION, AUTHORIZATION AND OPERATION OF AERODROMES

---

- (ii) Rapid exit taxiway indicator lights must be in accordance with the specifications in Appendix H, Figure AH-11 or Figure AH-12 as appropriate.
  - (iii) Rapid exit taxiway indicator lights must be supplied with power on a separate circuit to other runway lighting so that they may be used when other lighting is switched off.
- (n) Stopway lights
- (1) Application  
Stopway lights must be provided for a stopway intended for use at night.
  - (2) Location  
Stopway lights must be placed along the full length of the stopway and must be in two parallel rows that are equidistant from the centre line and coincident with the rows of the runway edge lights. Stopway lights must also be provided across the end of a stopway on a line at right angles to the stopway axis as near to the end of the stopway as possible and, in any case, not more than 3 m outside the end.
  - (3) Characteristics  
Stopway lights must be fixed unidirectional lights showing red in the direction of the runway.
- (o) Taxiway centre line lights
- (1) Application
    - (i) Taxiway centre line lights must be provided on an exit taxiway, taxiway, de-icing/anti-icing facility and apron intended for use in runway visual range conditions less than a value of 350 m in such a manner as to provide continuous guidance between the runway centre line and aircraft stands, except that these lights need not be provided where the traffic density is light and taxiway edge lights and centre line marking provide adequate guidance.
    - (ii) Taxiway centre line lights must be provided on a runway forming part of a standard taxi-route and intended for taxiing in runway visual range conditions less than a value of 350 m, except that these lights need not be provided where the traffic density is light and taxiway edge lights and centre line marking provide adequate guidance.
  - (2) Characteristics
    - (i) Except as provided for in § 139.505-(o)-(2)-(iii), taxiway centre line lights on a taxiway other than an exit taxiway and on a runway forming part of a standard taxi-route must be fixed lights showing green with beam dimensions such that the light is visible only from aeroplanes on or in the vicinity of the taxiway.
    - (ii) Taxiway centre line lights on an exit taxiway must be fixed lights. Alternate taxiway centre line lights must show green and yellow from their beginning near the runway centre line to the perimeter of the ILS/MLS critical/sensitive area or the lower edge of the inner transitional surface, whichever is farthest from the runway; and thereafter all

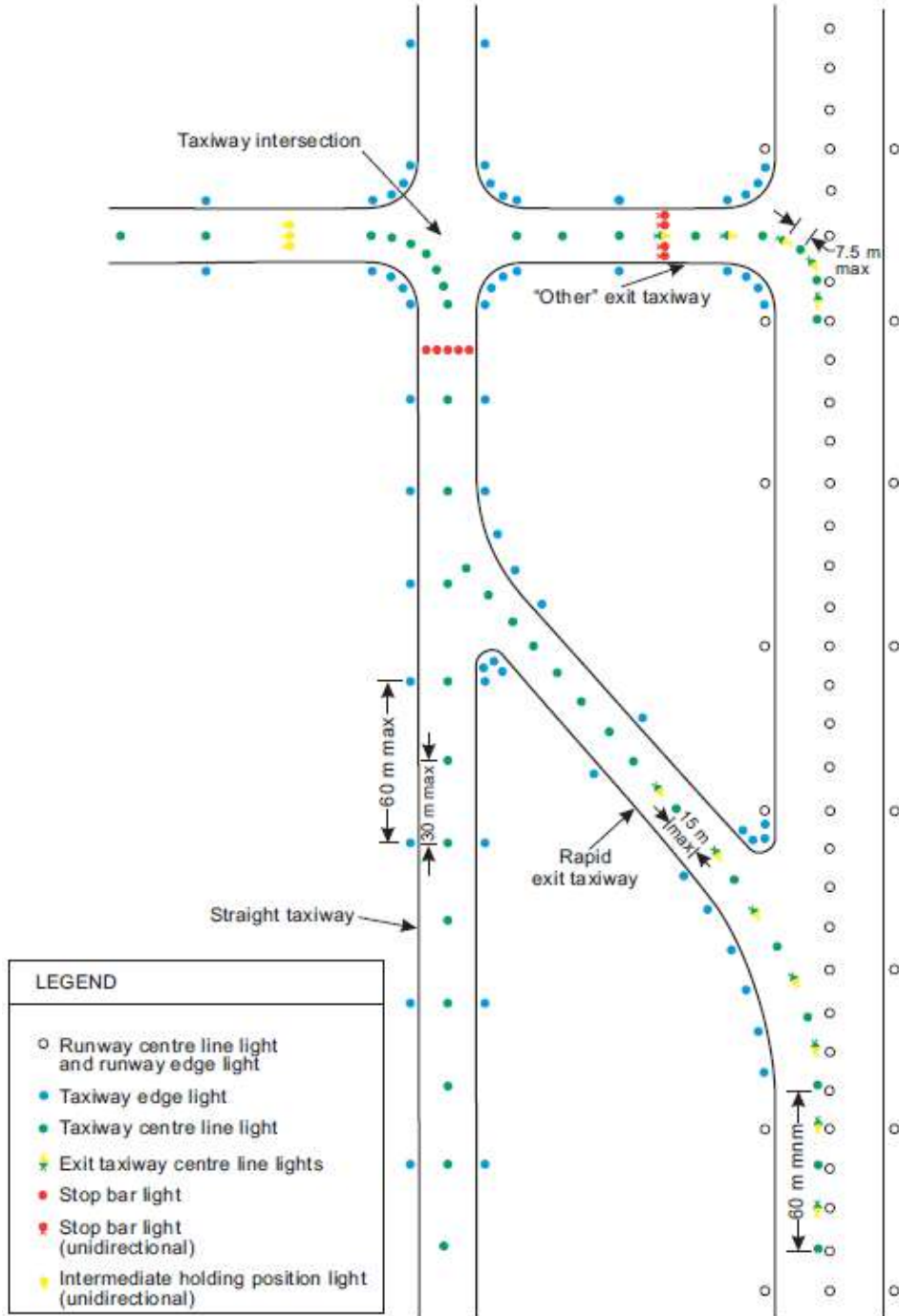
---

## GACAR PART 139 – CERTIFICATION, AUTHORIZATION AND OPERATION OF AERODROMES

---

- lights must show green (Figure H-23.). The first light in the exit centre line must always show green and the light nearest to the perimeter must always show yellow.
- (iii) Where it is necessary to denote the proximity to a runway, taxiway centre line lights must be fixed lights showing alternating green and yellow from the perimeter of the ILS/MLS critical/sensitive area or the lower edge of the inner transitional surface, whichever is farthest from the runway to the runway and continue alternating green and yellow until:
    - (A) Their end point near the runway centre line; or
    - (B) In the case of the taxiway centre line lights crossing the runway, to the opposite perimeter of the ILS/MLS critical/sensitive area or the lower edge of the inner transitional surface, whichever is farthest from the runway.
  - (iv) Taxiway centre line lights must be in accordance with the specifications of:
    - (A) Appendix H, Figure AH-17, AH-18 or AH-19 for taxiways intended for use in runway visual range conditions of less than a value of 350 m; and
    - (B) Appendix H, Figure AH-20 or AH-21 for other taxiways.
  - (v) Where higher intensities are required, from an operational point of view, taxiway centre line lights on rapid exit taxiways intended for use in runway visual range conditions less than a value of 350 m must be in accordance with the specifications of Appendix H, Figure AH-17. The number of levels of brilliancy settings for these lights must be the same as that for the runway centre line lights.
  - (vi) Where taxiway centre line lights are specified as components of an advanced surface movement guidance and control system and where, from an operational point of view, higher intensities are required to maintain ground movements at a certain speed in very low visibilities or in bright daytime conditions, taxiway centre line lights must be in accordance with the specifications of Appendix H, Figure AH-22, AH-23 or AH-24.

## GACAR PART 139 – CERTIFICATION, AUTHORIZATION AND OPERATION OF AERODROMES



**Figure H-23. Taxiway lighting**

---

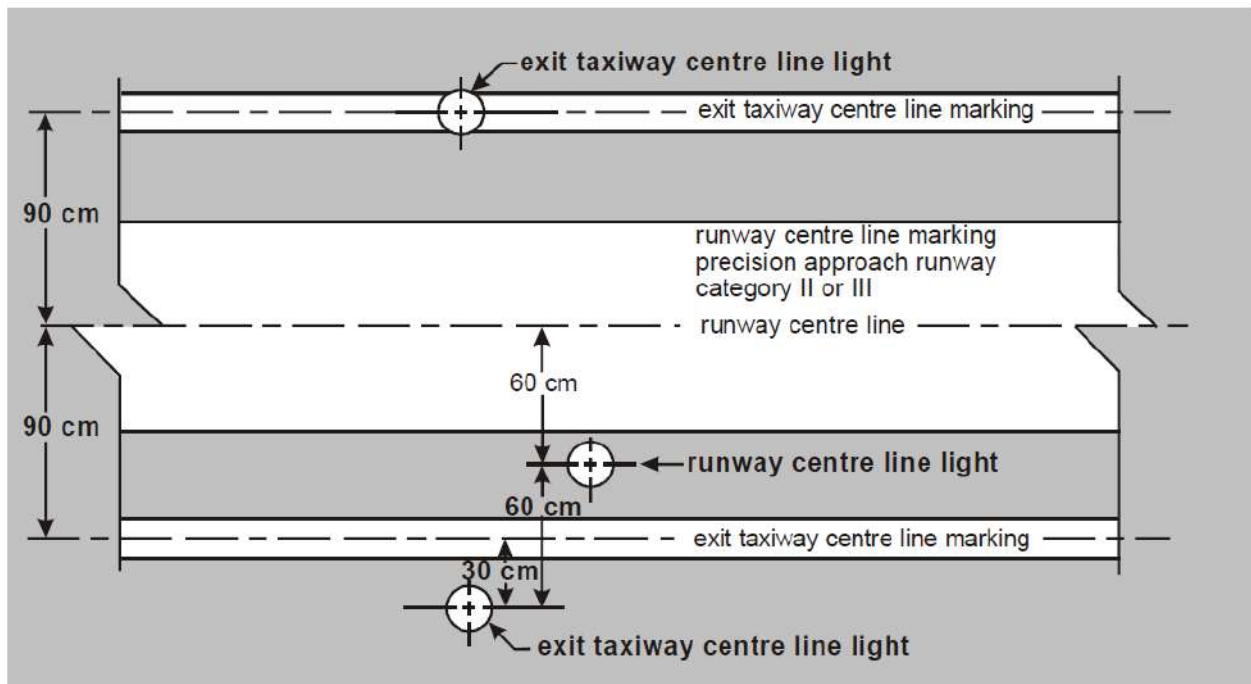
## GACAR PART 139 – CERTIFICATION, AUTHORIZATION AND OPERATION OF AERODROMES

---

- (3) Location  
Taxiway centre line lights must normally be located on the taxiway centre line marking, except that they may be offset by not more than 30 cm where it is not practicable to locate them on the marking.
- (4) Taxiway centre line lights on taxiways
  - (i) Location
    - (A) Taxiway centre line lights on a straight section of a taxiway must be spaced at longitudinal intervals of not more than 30 m, except that:
      - (I) Larger intervals not exceeding 60 m may be used where, because of the prevailing meteorological conditions, adequate guidance is provided by such spacing;
      - (II) Intervals less than 30 m must be provided on short straight sections; and
      - (III) On a taxiway intended for use in RVR conditions of less than a value of 350 m, the longitudinal spacing must not exceed 15 m.
    - (B) Taxiway centre line lights on a taxiway curve must continue from the straight portion of the taxiway at a constant distance from the outside edge of the taxiway curve. The lights must be spaced at intervals such that a clear indication of the curve is provided.
    - (C) On a taxiway intended for use in RVR conditions of less than a value of 350 m, the lights on a curve must not exceed a spacing of 15 m and on a curve of less than 400 m radius the lights must be spaced at intervals of not greater than 7.5 m. This spacing must extend for 60 m before and after the curve.
- (5) Taxiway centre line lights on rapid exit taxiways
  - (i) Location
    - (A) Taxiway centre line lights on a rapid exit taxiway must commence at a point at least 60 m before the beginning of the taxiway centre line curve and continue beyond the end of the curve to a point on the centre line of the taxiway where an aeroplane can be expected to reach normal taxiing speed. The lights on that portion parallel to the runway centre line must always be at least 60 cm from any row of runway centre line lights, as shown in Figure H-24.).
    - (B) The lights must be spaced at longitudinal intervals of not more than 15 m, except that, where runway centre line lights are not provided, a greater interval not exceeding 30 m may be used.
- (6) Taxiway centre line lights on other exit taxiways
  - (i) Location
    - (A) Taxiway centre line lights on exit taxiways other than rapid exit taxiways should commence at the point where the taxiway centre line marking begins to curve from the runway centre line and follow the curved taxiway centre line marking at least to the point where the marking leaves the runway. The first light should be at least 60 cm from any row of runway centre line lights, as shown in Figure H-24.

## GACAR PART 139 – CERTIFICATION, AUTHORIZATION AND OPERATION OF AERODROMES

(B) The lights should be spaced at longitudinal intervals of not more than 7.5 m.



Tolerances for offset runway centre line lights and taxiway centre line lights to maintain 60 cm separation.

**Figure H-24. Offset runway and taxiway centre line light**

(7) Taxiway centre line lights on runways

(i) Location

Taxiway centre line lights on a runway forming part of a standard taxi-route and intended for taxiing in runway visual range conditions less than a value of 350 m must be spaced at longitudinal intervals not exceeding 15 m.

(p) Taxiway edge lights

(1) Application

(i) Taxiway edge lights must be provided at the edges of a runway turn pad, holding bay, de-icing/anti-icing facility, apron, etc. intended for use at night and on a taxiway not provided with taxiway centre line lights and intended for use at night, except that

---

## GACAR PART 139 – CERTIFICATION, AUTHORIZATION AND OPERATION OF AERODROMES

---

- taxiway edge lights need not be provided where, considering the nature of the operations, adequate guidance can be achieved by surface illumination or other means.
- (ii) Taxiway edge lights must be provided on a runway forming part of a standard taxi-route and intended for taxiing at night where the runway is not provided with taxiway centre line lights.
- (2) Location
- (i) Taxiway edge lights on a straight section of a taxiway and on a runway forming part of a standard taxi-route must be spaced at uniform longitudinal intervals of not more than 60 m. The lights on a curve must be spaced at intervals less than 60 m so that a clear indication of the curve is provided.
  - (ii) Taxiway edge lights on a holding bay, de-icing/anti-icing facility, apron, etc. must be spaced at uniform longitudinal intervals of not more than 60 m.
  - (iii) Taxiway edge lights on a runway turn pad must be spaced at uniform longitudinal intervals of not more than 30 m.
  - (iv) The lights must be located as near as practicable to the edges of the taxiway, runway turn pad, holding bay, de-icing/anti-icing facility, apron or runway, etc. or outside the edges at a distance of not more than 3m.
- (3) Characteristics
- (i) Taxiway edge lights must be fixed lights showing blue. The lights must show up to at least 75° above the horizontal and at all angles in azimuth necessary to provide guidance to a pilot taxiing in either direction. At an intersection, exit or curve the lights must be shielded as far as practicable so that they cannot be seen in angles of azimuth in which they may be confused with other lights.
  - (ii) The intensity of taxiway edge lights must be at least 2 cd from 0° to 6° vertical, and 0.2 cd at any vertical angles between 6° and 75°.

### (q) Runway turn pad lights

#### (1) Application

- (i) Runway turn pad lights must be provided for continuous guidance on a runway turn pad intended for use in runway visual range conditions less than a value of 350 m, to enable an aeroplane to complete a 180-degree turn and align with the runway centre line.
- (ii) Runway turn pad lights must be provided on a runway turn pad intended for use at night.

#### (2) Location

- (i) Runway turn pad lights must normally be located on the runway turn pad marking, except that they may be offset by not more than 30 cm where it is not practicable to locate them on the marking.

---

## GACAR PART 139 – CERTIFICATION, AUTHORIZATION AND OPERATION OF AERODROMES

---

- (ii) Runway turn pad lights on a straight section of the runway turn pad marking must be spaced at longitudinal intervals of not more than 15 m.
  - (iii) Runway turn pad lights on a curved section of the runway turn pad marking must not exceed a spacing of 7.5 m.
  - (3) Characteristics
    - (i) Runway turn pad lights must be unidirectional fixed lights showing green with beam dimensions such that the light is visible only from aeroplanes on or approaching the runway turn pad.
    - (ii) Runway turn pad lights must be in accordance with the specifications of Appendix H, Figure AH-18, AH-19 or AH-20, as appropriate.
- (r) Stop bars
- (1) Application
    - (i) A stop bar must be provided at every runway-holding position serving a runway when it is intended that the runway will be used in runway visual range conditions less than a value of 550 m, except where:
      - (A) Appropriate aids and procedures are available to assist in preventing inadvertent incursions of traffic onto the runway; or
      - (B) Operational procedures exist to limit, in runway visual range conditions less than a value of 550 m, the number of:
        - (I) Aircraft on the manoeuvring area to one at a time; and
        - (II) Vehicles on the manoeuvring area to the essential minimum.
    - (ii) Where there is more than one stop bar associated with a taxiway/runway intersection, only one must be illuminated at any given time.
  - (2) Location

Stop bars must be located across the taxiway at the point where it is desired that traffic stop. Where the additional lights specified in § 139.505-(r)-(3) - (ii) are provided, these lights must be located not less than 3 m from the taxiway edge.
  - (3) Characteristics
    - (i) Stop bars must consist of lights spaced at uniform intervals of no more than 3 m across the taxiway, showing red in the intended direction(s) of approach to the intersection or runway-holding position.
    - (ii) A pair of elevated lights must be added to each end of the stop bar where the in-pavement stop bar lights might be obscured from a pilot's view, for example, by snow or rain, or where a pilot may be required to stop the aircraft in a position so close to the lights that they are blocked from view by the structure of the aircraft.



---

## GACAR PART 139 – CERTIFICATION, AUTHORIZATION AND OPERATION OF AERODROMES

---

- (iii) Stop bars installed at a runway-holding position must be unidirectional and must show red in the direction of approach to the runway.
- (iv) Where the additional lights specified in § 139.505-(r)-(3)-(ii) are provided, these lights must have the same characteristics as the lights in the stop bar but must be visible to approaching aircraft up to the stop bar position.
- (v) The intensity in red light and beam spreads of stop bar lights must be in accordance with the specifications in Appendix H, Figures AH-17 through AH-21, as appropriate.
- (vi) The lighting circuit must be designed so that:
  - (A) Stop bars located across entrance taxiways are selectively switchable;
  - (B) Stop bars located across taxiways intended to be used only as exit taxiways are switchable selectively or in groups;
  - (C) When a stop bar is illuminated, any taxiway centre line lights installed beyond the stop bar must be extinguished for a distance of at least 90 m; and
  - (D) Stop bars are interlocked with the taxiway centre line lights so that when the centre line lights beyond the stop bar are illuminated the stop bar is extinguished and vice versa.

### (s) Intermediate holding position lights

#### (1) Application

- (i) Except where a stop bar has been installed, intermediate holding position lights must be provided at an intermediate holding position intended for use in runway visual range conditions less than a value of 350 m.
- (ii) Intermediate holding position lights must be provided at an intermediate holding position where there is no need for stop-and-go signals as provided by a stop bar.

#### (2) Location

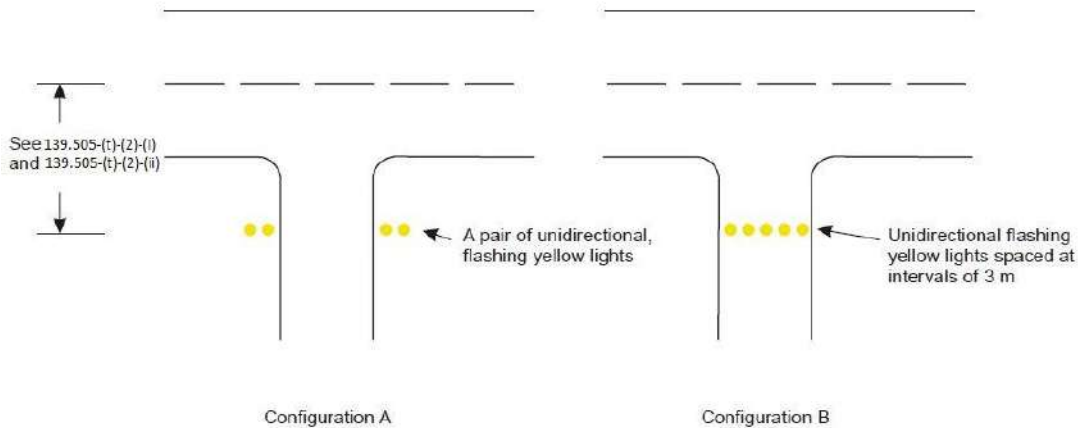
Intermediate holding position lights must be located along the intermediate holding position marking at a distance of 0.3 m prior to the marking.

#### (3) Characteristics

Intermediate holding position lights must consist of three fixed unidirectional lights showing yellow in the direction of approach to the intermediate holding position with a light distribution similar to taxiway centre line lights if provided. The lights must be disposed symmetrically about and at right angle to the taxiway centre line, with individual lights spaced 1.5 m apart.

## GACAR PART 139 – CERTIFICATION, AUTHORIZATION AND OPERATION OF AERODROMES

### (t) Runway guard lights



**Figure H-25. Runway guard light**

- (1) Application
  - (i) Runway guard lights, Configuration A, must be provided at each taxiway/runway intersection associated with a runway intended for use in:
    - (A) Runway visual range conditions less than a value of 550 m where a stop bar is not installed; and
    - (B) Runway visual range conditions of values between 550 m and 1,200 m where the traffic density is heavy.
  - (ii) Configuration B runway guard lights must not be collocated with a stop bar.
  - (iii) Where more than one runway-holding positions exist at a runway/taxiway intersection, only the set of runway guard lights associated with the operational runway-holding position shall be illuminated.
- (2) Location
  - (i) Runway guard lights, Configuration A, must be located at each side of the taxiway on the holding side of the runway-holding position marking.
  - (ii) Runway guard lights, Configuration B, must be located across the taxiway on the holding side of the runway-holding position marking.
- (3) Characteristics
  - (i) Runway guard lights, Configuration A, must consist of two pairs of yellow lights.
  - (ii) Where there is a need to enhance the contrast between the on and off state of runway guard lights, Configuration A, intended for use during the day, a visor of sufficient size to prevent sunlight from entering the lens without interfering with the function of the fixture must be located above each lamp.

---

## GACAR PART 139 – CERTIFICATION, AUTHORIZATION AND OPERATION OF AERODROMES

---

- (iii) Runway guard lights, Configuration B, must consist of yellow lights spaced at intervals of 3 m across the taxiway.
  - (iv) The light beam must be unidirectional and must show yellow in the direction of approach to the runway- holding position.
  - (v) The intensity in yellow light and beam spreads of lights of Configuration A must be in accordance with the specifications in Appendix H, Figure AH-28.
  - (vi) Where runway guard lights are intended for use during the day, the intensity in yellow light and beam spreads of lights of Configuration A must be in accordance with the specifications in Appendix H, Figure AH-29.
  - (vii) Where runway guard lights are specified as components of an advanced surface movement guidance and control system where higher light intensities are required, the intensity in yellow light and beam spreads of lights of Configuration A must be in accordance with the specifications in Appendix H, Figure AH-29.
  - (viii) The intensity in yellow light and beam spreads of lights of Configuration B must be in accordance with the specifications in Appendix H, Figure AH-17.
  - (ix) Where runway guard lights are intended for use during the day, the intensity in yellow light and beam spreads of lights of Configuration B must be in accordance with the specifications in Appendix H, Figure AH-25.
  - (x) Where runway guard lights are specified as components of an advanced surface movement guidance and control system where higher light intensities are required, the intensity in yellow light and beam spreads of lights of Configuration B must be in accordance with the specifications in Appendix H, Figure AH-25.
  - (xi) The lights in each unit of Configuration A must be illuminated alternately.
  - (xii) For Configuration B, adjacent lights must be alternately illuminated, and alternative lights must be illuminated in unison.
  - (xiii) The lights must be illuminated between 30 and 60 cycles per minute and the light suppression and illumination periods must be equal and opposite in each light.
- (u) Apron floodlighting (See also § 139.505-(o)-(1)-(i) and § 139.505-(p)-(1)-(i))
- (1) Application  

Apron floodlighting must be provided on an apron, on a de-icing/anti-icing facility and on a designated isolated aircraft parking position intended to be used at night.
  - (2) Location  

Apron floodlights must be located so as to provide adequate illumination on all apron service areas, with a minimum of glare to pilots of aircraft in flight and on the ground, Aerodrome and apron controllers, and personnel on the apron. The arrangement and

---

## GACAR PART 139 – CERTIFICATION, AUTHORIZATION AND OPERATION OF AERODROMES

---

aiming of floodlights must be such that an aircraft stand receives light from two or more directions to minimize shadows.

(3) Characteristics

(i) The spectral distribution of apron floodlights must be such that the colors used for aircraft marking connected with routine servicing, and for surface and obstacle marking, can be correctly identified.

(ii) The average illuminance must be at least the following:

(A) Aircraft stand:

(I) Horizontal illuminance — 20 lux with a uniformity ratio (average to minimum) of not more than 4 to 1; and

(II) Vertical illuminance — 20 lux at a height of 2 m above the apron in relevant directions.

(B) Other apron areas:

Horizontal illuminance — 50 per cent of the average illuminance on the aircraft stands with a uniformity ratio (average to minimum) of not more than 4 to 1.

(v) Visual docking guidance system

(1) Application

A visual docking guidance system must be provided when it is intended to indicate, by a visual aid, the precise positioning of an aircraft on an aircraft stand and other alternative means such as marshallers are not practicable.

(2) Characteristics

(i) The system must provide both azimuth and stopping guidance.

(ii) The azimuth guidance unit and the stopping position indicator must be adequate for use in all weather, visibility, background lighting and pavement conditions for which the system is intended both by day and night but must not dazzle the pilot.

(iii) The azimuth guidance unit and the stopping position indicator must be of a design such that:

(A) A clear indication of malfunction of either or both is available to the pilot; and

(B) They can be turned off.

---

## GACAR PART 139 – CERTIFICATION, AUTHORIZATION AND OPERATION OF AERODROMES

---

- (iv) The azimuth guidance unit and the stopping position indicator must be located in such a way that there is continuity of guidance between the aircraft stand markings, the aircraft stand manoeuvring guidance lights, if present, and the visual docking guidance system.
  - (v) The accuracy of the system must be adequate for the type of loading bridge and fixed aircraft servicing installations with which it is to be used.
  - (vi) If selective operation is required to prepare the system for use by a particular type of aircraft, then the system must provide an identification of the selected aircraft type to both the pilot and the system operator as a means of ensuring that the system has been set properly.
- (3) Azimuth guidance unit
- (i) Location  
The azimuth guidance unit must be located on or close to the extension of the stand centre line ahead of the aircraft so that its signals are visible from the cockpit of an aircraft throughout the docking manoeuvre and aligned for use at least by the pilot occupying the left seat.
  - (ii) Characteristics
    - (A) The azimuth guidance unit must provide unambiguous left/right guidance which enables the pilot to acquire and maintain the lead-in line without over controlling.
    - (B) When azimuth guidance is indicated by color change, green must be used to identify the centre line and red for deviations from the centre line.
- (4) Stopping position indicator
- (i) Location
    - (A) The stopping position indicator must be located in conjunction with, or sufficiently close to, the azimuth guidance unit so that a pilot can observe both the azimuth and stop signals without turning the head.
    - (B) The stopping position indicator must be usable at least by the pilot occupying the left seat.
  - (ii) Characteristics
    - (A) The stopping position information provided by the indicator for a particular aircraft type must account for the anticipated range of variations in pilot eye height and/or viewing angle.
    - (B) The stopping position indicator must show the stopping position for the aircraft for which guidance is being provided and must provide closing rate information to enable the pilot to gradually decelerate the aircraft to a full stop at the intended stopping position.
    - (C) The stopping position indicator must provide closing rate information over a distance of at least 10 m.

---

## GACAR PART 139 – CERTIFICATION, AUTHORIZATION AND OPERATION OF AERODROMES

---

- (D) When stopping guidance is indicated by color change, green must be used to show that the aircraft can proceed and red to show that the stop point has been reached except that for a short distance prior to the stop point a third color may be used to warn that the stopping point is close.
- (w) Advanced visual docking guidance system
- (1) Application
- (i) An A-VDGS must be provided where it is operationally desirable to confirm the correct aircraft type for which guidance is being provided, and/or to indicate the stand centre line in use, where more than one is provided for.
- (ii) The A-VDGS must be suitable for use by all types of aircraft for which the aircraft stand is intended.
- (iii) The A-VDGS must only be used in conditions in which its operational performance is specified.
- (iv) The docking guidance information provided by an A-VDGS must not conflict with that provided by a conventional visual docking guidance system on an aircraft stand if both types are provided and are in operational use. A method of indicating that the A-VDGS is not in operational use or unserviceable, must be provided.
- (2) Location  
The A-VDGS must be located such that unobstructed and unambiguous guidance is provided to the person responsible for, and persons assisting, the docking of the aircraft throughout the docking manoeuvre.
- (3) Characteristics
- (i) The A-VDGS must provide, at minimum, the following guidance information at the appropriate stage of the docking manoeuvre:
- (A) An emergency stop indication;
- (B) The aircraft type and model for which the guidance is provided;
- (C) An indication of the lateral displacement of the aircraft relative to the stand centre line;
- (D) The direction of azimuth correction needed to correct a displacement from the stand centre line;
- (E) An indication of the distance to the stop position;
- (F) An indication when the aircraft has reached the correct stopping position; and
- (G) A warning indication if the aircraft goes beyond the appropriate stop position.
- (ii) The A-VDGS must be capable of providing docking guidance information for all aircraft taxi speeds encountered during the docking manoeuvre.

## GACAR PART 139 – CERTIFICATION, AUTHORIZATION AND OPERATION OF AERODROMES

- (iii) The time taken from the determination of the lateral displacement to its display must not result in a deviation of the aircraft, when operated in normal conditions, from the stand centreline greater than 1 m.
- (iv) The information on displacement of the aircraft relative to the stand centre line and distance to the stopping position, when displayed, must be provided with the accuracy specified in Table H-4.
- (v) Symbols and graphics used to depict guidance information must be intuitively representative of the type of information provided.
- (vi) Information on the lateral displacement of the aircraft relative to the stand centre line must be provided at least 25m prior to the stop position.
- (vii) Continuous closure distance and closure rate must be provided from at least 15 m prior to the stop position.
- (viii) Where provided, closure distance displayed in numerals must be provided in meter integers to the stop position and displayed to 1 decimal place at least 3 m prior to the stop position.
- (ix) Throughout the docking manoeuvre, an appropriate means must be provided on the AVDGS to indicate the need to bring the aircraft to an immediate halt. In such an event, which includes a failure of the A-VDGS, no other information must be displayed.
- (x) Provision to initiate an immediate halt to the docking procedure must be made available to personnel responsible for the operational safety of the stand.
- (xi) The word “STOP” in red characters must be displayed when an immediate cessation of the docking manoeuvre is required.

| Guidance information | Maximum deviation at<br>stop position<br>(stop area) | Maximum deviation at<br>9 m from<br>stop position | Maximum deviation at<br>15 m from<br>stop position | Maximum deviation at<br>25 m from<br>stop position |
|----------------------|--|---|--|--|
| Azimuth              | ±250 mm  | ±340 mm   | ±400 mm  | ±500 mm  |
| Distance             | ±500 mm  | ±1 000 mm   | ±1 300 mm  | Not specified                                      |

**Table H-4. A-VDGS recommended displacement accuracy**

(x) Aircraft stand manoeuvring guidance lights

(1) Application

---

## GACAR PART 139 – CERTIFICATION, AUTHORIZATION AND OPERATION OF AERODROMES

---

Aircraft stand manoeuvring guidance lights must be provided to facilitate the positioning of an aircraft on an aircraft stand on a paved apron or on a de-icing/anti-icing facility intended for use in poor visibility conditions unless adequate guidance is provided by other means.

(2) Location

Aircraft stand manoeuvring guidance lights must be collocated with the aircraft stand markings.

(3) Characteristics

- (i) Aircraft stand manoeuvring guidance lights, other than those indicating a stop position, must be fixed yellow lights, visible throughout the segments within which they are intended to provide guidance.
- (ii) The lights used to delineate lead-in, turning and lead-out lines must be spaced at intervals of not more than 7.5 m on curves and 15 m on straight sections.
- (iii) The lights indicating a stop position must be fixed, unidirectional lights, showing red.
- (iv) The intensity of the lights must be adequate for the condition of visibility and ambient light in which the use of the aircraft stand is intended.
- (v) The lighting circuit must be designed so that the lights may be switched on to indicate that an aircraft stand is to be used and switched off to indicate that it is not to be used.

(y) Road-holding position light

(1) Application

A road-holding position light must be provided at each road-holding position serving a runway when it is intended that the runway will be used in runway visual range conditions less than a value of 350 m.

(2) Location

A road-holding position light must be located adjacent to the holding position marking 1.5 m (+/- 0.5 m) from one edge of the road, i.e., left or right as appropriate to the local traffic regulations.

(3) Characteristics

- (i) The road-holding position light must comprise:
  - (A) A controllable red (stop)/green (go) traffic light; or
  - (B) A flashing-red light.
- (ii) The road-holding position light beam must be unidirectional and aligned so as to be visible to the driver of a vehicle approaching the holding position.
- (iii) The intensity of the light beam must be adequate for the conditions of visibility and ambient light in which the use of the holding position is intended but must not dazzle the driver.



---

## GACAR PART 139 – CERTIFICATION, AUTHORIZATION AND OPERATION OF AERODROMES

---

- (iv) The flash frequency of the flashing-red light must be between 30 and 60 per minute.

### § 139.507 Signs

(a) General

(1) Application

Signs must be provided to convey a mandatory instruction, information on a specific location or destination on a movement area or to provide other information to meet the requirements of § 139.915- (1).

(2) Characteristics


- (i) Signs must be frangible. Those located near a runway or taxiway must be sufficiently low to preserve clearance for propellers and the engine pods of jet aircraft. The installed height of the sign must not exceed the dimension shown in the appropriate column of Table H-5.
- (ii) Signs must be rectangular, as shown in Figure H-26 and Figure H-27 with the longer side horizontal.
- (iii) The only signs on the movement area utilizing red must be mandatory instruction signs.
- (iv) The inscriptions on a sign must be in accordance with the provisions of Appendix H.
- (v) Signs must be illuminated in accordance with the provisions of Appendix H when intended for use:
- (A) In runway visual range conditions less than a value of 800 m; or
- (B) At night in association with instrument runways; or
- (C) At night in association with non-instrument runways where the code number is 3 or 4.
- (vi) Signs must be retroreflective and/or illuminated in accordance with the provisions of Appendix H when intended for use at night in association with non-instrument runways where the code number is 1 or 2.
- (vii) A variable message sign must show a blank face when not in use.
- (viii) In case of failure, a variable message sign must not provide information that could lead to unsafe action from a pilot or a vehicle driver.

**GACAR PART 139 – CERTIFICATION, AUTHORIZATION AND OPERATION OF  
AERODROMES**

| Sign height (mm) |        |             |                  | Perpendicular distance from defined taxiway pavement edge to near side of sign | Perpendicular distance from defined runway pavement edge to near side of sign |
|------------------|--------|-------------|------------------|--|---|
| Code Number      | Legend | Face (min.) | Installed (max.) |  |   |
| 1 or 2           | 200    | 300         | 700              | 5-11 m   | 3-10 m  |
| 1 or 2           | 300    | 450         | 900              | 5-11 m   | 3-10 m  |
| 3 or 4           | 300    | 450         | 900              | 11-21 m  | 8-15 m  |
| 3 or 4           | 400    | 600         | 1100             | 11-21 m  | 8-15 m  |

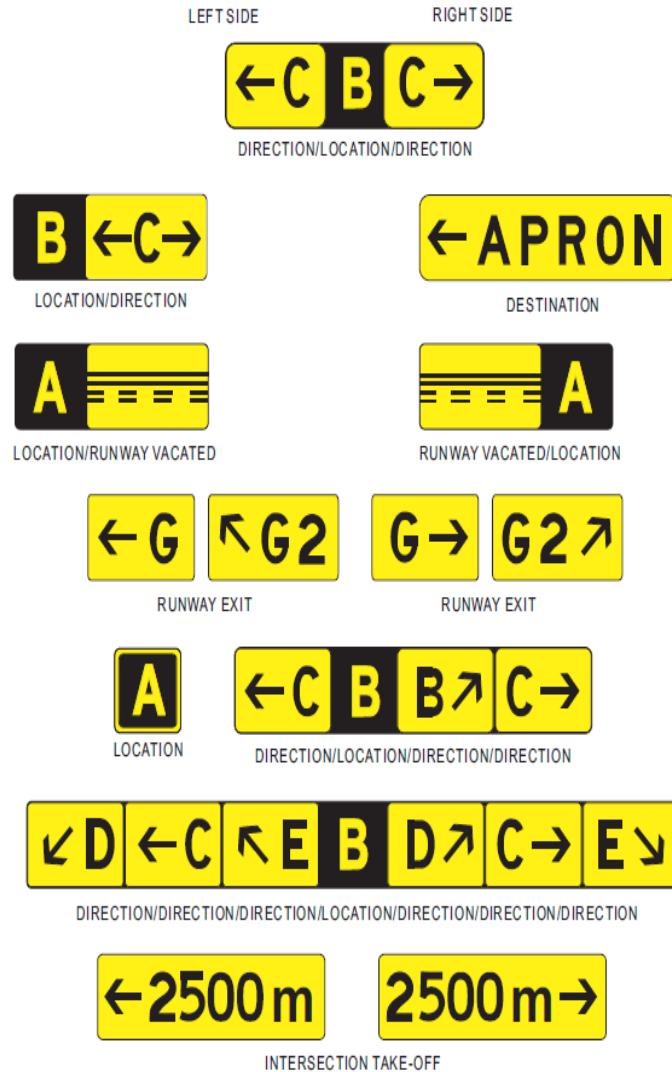
**Table H-5. Location distances for taxing guidance signs including runway exit signs.**

## GACAR PART 139 – CERTIFICATION, AUTHORIZATION AND OPERATION OF AERODROMES

|  |   |  |
|--|---|--|
| Runway designation of a runway extremity (Example)           | <b>25</b>   | Indicates a runway-holding position at a runway extremity  |
| Runway designation of both extremities of a runway (Example) | <b>25-07</b>  | Indicates a runway-holding position located at taxiway/runway intersection other than runway extremity |
| Category I hold position (Example)                           | <b>25 CAT I</b>   | Indicates a category I runway-holding position at the threshold of runway 25                           |
| Category II hold position (Example)                          | <b>25 CAT II</b>  | Indicates a category II runway-holding position at the threshold of runway 25                          |
| Category III hold position (Example)                         | <b>25 CAT III</b>   | Indicates a category III runway-holding position at the threshold of runway 25                         |
| Category II and III hold position (Example)                  | <b>25 CAT II/III</b>  | Indicates a joint category II and III runway-holding position at the threshold of runway 25            |
| Category I, II and III hold position (Example)               | <b>25 CAT I/II/III</b>  | Indicates a joint category I, II and III runway-holding position at the threshold of runway 25         |
| NO ENTRY   |  | Indicates that entry to an area is prohibited  |
| Runway-holding position (Example)                            | <b>B2</b>   | Indicates a runway-holding position (in accordance with 139.323 (a) (3))                               |

**Figure H-26. Mandatory Instruction signs**

## GACAR PART 139 – CERTIFICATION, AUTHORIZATION AND OPERATION OF AERODROMES



**Figure H-27. Information signs**

(b) Mandatory instruction signs

(1) Application

- (i) A mandatory instruction sign must be provided to identify a location beyond which an aircraft taxiing or vehicle must not proceed unless authorized by the Aerodrome control tower.

---

## GACAR PART 139 – CERTIFICATION, AUTHORIZATION AND OPERATION OF AERODROMES

---

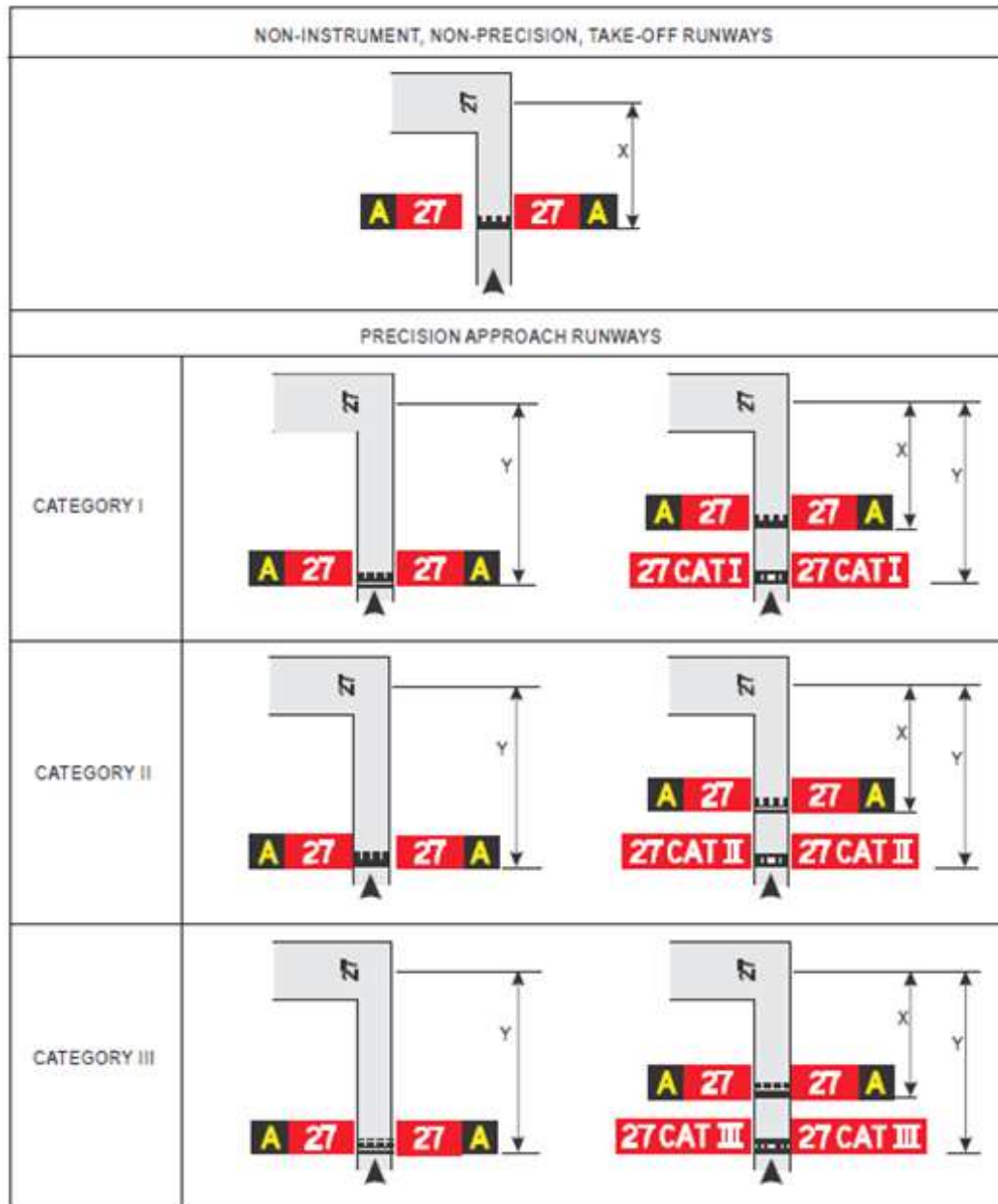
- (ii) Mandatory instruction signs must include runway designation signs, category I, II or III holding position signs, runway-holding position signs, road-holding position signs and NO ENTRY signs.
  - (iii) A pattern “A” runway-holding position marking must be supplemented at a taxiway/runway intersection or a runway/runway intersection with a runway designation sign.
  - (iv) A pattern “B” runway-holding position marking must be supplemented with a category I, II or III holding position sign.
  - (v) A pattern “A” runway-holding position marking at a runway-holding position established in accordance with § 139.323-(a)-(3) must be supplemented with a runway-holding position sign.
  - (vi) A runway designation sign at a taxiway/runway intersection must be supplemented with a location sign in the outboard (farthest from the taxiway) position, as appropriate.
  - (vii) A “NO ENTRY” sign must be provided when entry into an area is prohibited.
- (2) Location
- (i) A runway designation signs at a taxiway/runway intersection or a runway/runway intersection must be located on each side of the runway-holding position marking facing the direction of approach to the runway.
  - (ii) A category I, II or III holding position sign must be located on each side of the runway-holding position marking facing the direction of the approach to the critical area.
  - (iii) A NO ENTRY sign must be located at the beginning of the area to which entrance is prohibited on each side of the taxiway as viewed by the pilot.
  - (iv) A runway-holding position sign must be located on each side of the runway-holding position established in accordance with § 139.323-(a)-(3), facing the approach to the obstacle limitation surface or ILS/MLS critical/sensitive area, as appropriate.
- (3) Characteristics
- (i) A mandatory instruction sign must consist of an inscription in white on a red background.
  - (ii) Where, owing to environmental or other factors, the conspicuity of the inscription on a mandatory instruction sign needs to be enhanced, the outside edge of the white inscription must be supplemented by a black outline measuring 10 mm in width for runway code numbers 1 and 2, and 20 mm in width for runway code numbers 3 and 4.
  - (iii) The inscription on a runway designation sign must consist of the runway designations of the intersecting runway properly oriented with respect to the viewing position of the sign, except that a runway designation sign installed in the vicinity of a runway extremity may show the runway designation of the concerned runway extremity only.

## **GACAR PART 139 – CERTIFICATION, AUTHORIZATION AND OPERATION OF AERODROMES**

---

- (iv) The inscription on a category I, II, III or joint II/III holding position sign must consist of the runway designator followed by CAT I, CAT II, CAT III or CAT II/III, as appropriate.
- (v) The inscription on a NO ENTRY sign must be in accordance with Figure H-26.
- (vi) The inscription on a runway-holding position sign at a runway-holding position established in accordance with §139.323-(a) -(3) must consist of the taxiway designation and a number.
- (vii) Where installed, the inscriptions/ symbol of Figure H-26 must be used.

## GACAR PART 139 – CERTIFICATION, AUTHORIZATION AND OPERATION OF AERODROMES



*Note.— Distance X is established in accordance with Table F-2. Distance Y is established at the edge of the ILS/MLS critical/sensitive area.*

**Figure H-28. Example of sign positions at taxiway/runway intersections**

---

## GACAR PART 139 – CERTIFICATION, AUTHORIZATION AND OPERATION OF AERODROMES

---

### (c) Information signs

#### (1) Application

- (i) An information sign must be provided where there is an operational need to identify by a sign, a specific location, or routing (direction or destination) information.
- (ii) Information signs must include direction signs, location signs, destination signs, runway exit signs, runway vacated signs and intersection take-off signs.
- (iii) A runway exit sign must be provided where there is an operational need to identify a runway exit.
- (iv) A runway vacated sign must be provided where the exit taxiway is not provided with taxiway centre line light sand there is a need to indicate to a pilot leaving a runway the perimeter of the ILS/MLS critical/sensitive area or the lower edge of the inner transitional surface whichever is farther from the runway centre line.
- (v) An intersection take-off sign must be provided when there is an operational need to indicate the remaining take-off run available (TORA) for intersection take-offs.
- (vi) Where necessary, a destination sign must be provided to indicate the direction to a specific destination on the Aerodrome, such as cargo area, general aviation, etc.
- (vii) A combined location and direction sign must be provided when it is intended to indicate routing information prior to a taxiway intersection.
- (viii) A direction sign must be provided when there is an operational need to identify the designation and direction of taxiways at an intersection.
- (ix) A location sign must be provided at an intermediate holding position.
- (x) A location sign must be provided in conjunction with a runway designation sign except at a runway/runway intersection.
- (xi) A location sign must be provided in conjunction with a direction sign, except that it may be omitted where an Aeronautical study indicates that it is not needed.
- (xii) Where necessary, a location sign must be provided to identify taxiways exiting an apron or taxiways beyond an intersection.
- (xiii) Where a taxiway ends at an intersection such as a “T” and it is necessary to identify this, a barricade, direction sign and/or other appropriate visual aid must be used.

#### (2) Location

- (i) Except as specified in § 139.507-(c)-(2) - (iii) and § 139.507-(c)-(2) - (xi) information signs must, wherever practicable, be located on the left-hand side of the taxiway in accordance with Table H-5.
- (ii) At a taxiway intersection, information signs must be located prior to the intersection and in line with the intermediate holding position marking. Where there is no taxiway intersection marking, the signs must be installed at least 60 m from the centre line of the intersecting taxiway where the code number is 3 or 4 and at least 40 m where the code number is 1 or 2.



---

## GACAR PART 139 – CERTIFICATION, AUTHORIZATION AND OPERATION OF AERODROMES

---

- (iii) A runway exit sign must be located on the same side of the runway as the exit is located (i.e. left or right) and positioned in accordance with Table H-5.
  - (iv) A runway exit sign must be located prior to the runway exit point in line with a position at least 60 m prior to the point of tangency where the code number is 3 or 4, and at least 30 m where the code number is 1 or 2.
  - (v) A runway vacated sign must be located at least on one side of the taxiway. The distance between the sign and the centre line of a runway must be not less than the greater of the following:
    - (A) The distance between the centre line of the runway and the perimeter of the ILS/MLS critical/sensitive area; or
    - (B) The distance between the centre line of the runway and the lower edge of the inner transitional surface.
  - (vi) Where provided in conjunction with a runway vacated sign, the taxiway location sign must be positioned outboard of the runway vacated sign.
  - (vii) An intersection take-off sign must be located at the left-hand side of the entry taxiway. The distance between the sign and the centre line of the runway must be not less than 60 m where the code number is 3 or 4 and not less than 45 m where the code number is 1 or 2.
  - (viii) A taxiway location sign installed in conjunction with a runway designation sign must be positioned outboard of the runway designation sign.
  - (ix) A destination sign must not normally be collocated with a location or direction sign.
  - (x) An information sign other than a location sign must not be collocated with a mandatory instruction sign.
  - (xi) A direction sign, barricade and/or other appropriate visual aid used to identify a “T” intersection must be located on the opposite side of the intersection facing the taxiway.
- (3) Characteristics
- (i) An information signs other than a location sign must consist of an inscription in black on a yellow background.
  - (ii) A location sign must consist of an inscription in yellow on a black background and where it is a stand-alone sign must have a yellow border.
  - (iii) The inscription on a runway exit sign must consist of the designator of the exit taxiway and an arrow indicating the direction to follow.
  - (iv) The inscription on a runway-vacated sign must depict the pattern a runway-holding position marking as shown in Figure H-27.
  - (v) The inscription on an intersection take-off sign must consist of a numerical message indicating the remaining take-off run available in meters plus an arrow, appropriately located and oriented, indicating the direction of the take-off as shown in Figure H-27.
  - (vi) The inscription on a destination sign must comprise an alpha, alphanumeric or numerical message identifying the destination plus an arrow indicating the direction to proceed as shown in Figure H-27.

---

## GACAR PART 139 – CERTIFICATION, AUTHORIZATION AND OPERATION OF AERODROMES

---

- (vii) The inscription on a direction sign must comprise an alpha or alphanumerical message identifying the taxiway(s) plus an arrow or arrows appropriately oriented as shown in Figure H-27.
- (viii) The inscription on a location sign must comprise the designation of the location taxiway, runway or other pavement the aircraft is on or is entering and must not contain arrows.
- (ix) Where it is necessary to identify each of a series of intermediate holding positions on the same taxiway, the location sign must consist of the taxiway designation and a number.
- (x) Where a location sign and direction signs are used in combination:
  - (A) All direction signs related to left turns must be placed on the left side of the location sign and all direction signs related to right turns must be placed on the right side of the location sign, except that where the junction consists of one intersecting taxiway, the location sign may alternatively be placed on the left-hand side;
  - (B) The direction signs must be placed such that the direction of the arrows departs increasingly from the vertical with increasing deviation of the corresponding taxiway;
  - (C) An appropriate direction sign must be placed next to the location sign where the direction of the location taxiway changes significantly beyond the intersection; and
  - (D) Adjacent direction signs must be delineated by a vertical black line as shown in Figure H-27.
- (xi) A taxiway must be identified by a designator that is used only once on an Aerodrome comprising a single letter, two letters or a combination of a letter or letters followed by a number.
- (xii) When designating taxiways, the use of words such as inner and outer must be avoided wherever possible.
- (xiii) When designating taxiways, the use of the letters I, O or X must not be used to avoid confusion with the numerals 1, 0 and closed marking.
- (xiv) The use of numbers alone on the manoeuvring area must be reserved for the designation of runways.
- (xv) Apron stand designators must not be the same as taxiway designators.

### (d) VOR Aerodrome check-point sign

#### (1) Application

When a VOR Aerodrome checkpoint is established, it must be indicated by a VOR Aerodrome check-point marking and sign.

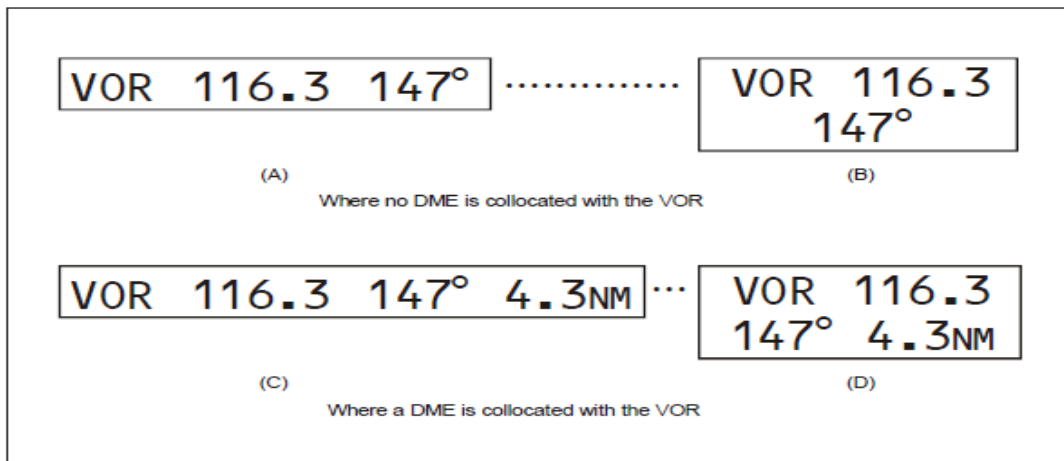
## GACAR PART 139 – CERTIFICATION, AUTHORIZATION AND OPERATION OF AERODROMES

(2) Location

A VOR Aerodrome check-point sign must be located as near as possible to the checkpoint and so that the inscriptions are visible from the cockpit of an aircraft properly positioned on the VOR Aerodrome check-point marking.

(3) Characteristics

- (i) A VOR Aerodrome check-point sign must consist of an inscription in black on a yellow background.
- (ii) The inscriptions on a VOR check-point sign must be in accordance with one of the alternatives shown in Figure H-29 in which:
  - VOR is an abbreviation identifying this as a VOR checkpoint;
  - 116.3 is an example of the radio frequency of the VOR concerned;
  - 147° is an example of the VOR bearing, to the nearest degree, which must be indicated at the VOR checkpoint; and
  - 4.3 NM is an example of the distance in nautical miles to a DME collocated with the VOR concerned.



**Figure H-29. VOR Aerodrome checkpoint sign**

(e) Road-holding position sign

A road-holding position sign must be provided at all road entrances to a runway.

(1) Location

---

## GACAR PART 139 – CERTIFICATION, AUTHORIZATION AND OPERATION OF AERODROMES

---

The road-holding position sign must be located 1.5 m from one edge of the road (left or right as appropriate to the local traffic regulations) at the holding position.

- (2) Characteristics
  - (i) A road-holding position sign must consist of an inscription in white on a red background.
  - (ii) The inscription on a road-holding position sign must be in the national language, be in conformity with the local traffic regulations and include the following:
    - (A) A requirement to stop; and
    - (B) Where appropriate:
      - (I) A requirement to obtain ATC clearance; and
      - (II) Location designator.
    - (iii) A road-holding position sign intended for night use must be retro-reflective or illuminated.

### § 139.509 Markers

#### (a) General

Markers must be frangible. Those located near a runway or taxiway must be sufficiently low to preserve clearance for propellers and for the engine pods of jet aircraft.

## **GACAR PART 139 – CERTIFICATION, AUTHORIZATION AND OPERATION OF AERODROMES**

---

### **SUBPART I – VISUAL AIDS FOR DENOTING OBSTACLES**

#### **§ 139.601 Objects to be marked and/or lighted**

(a) Objects within the lateral boundaries of the obstacle limitation surfaces

- (1) Vehicles and other mobile objects, excluding aircraft, on the movement area of an aerodrome are obstacles and must be marked and, if the vehicles and aerodrome are used at night or in conditions of low visibility, lighted, except that aircraft servicing equipment and vehicles used only on aprons may be exempt.
- (2) Elevated aeronautical ground lights within the movement area must be marked so as to be conspicuous by day. Obstacle lights must not be installed on elevated ground lights or signs in the movement area.
- (3) All obstacles within the distance specified in Table F-1, column 11 or 12, from the centre line of a taxiway, an apron taxiway or aircraft stand taxilane must be marked and, if the taxiway, apron taxiway or aircraft stand taxilane is used at night, lighted.
- (4) A fixed obstacle that extends above a take-off climb surface within 3,000 m of the inner edge of the take-off climb surface must be marked and, if the runway is used at night, lighted, except that:
  - (i) Such marking and lighting may be omitted when the obstacle is shielded by another fixed obstacle;
  - (ii) The marking may be omitted when the obstacle is lighted by medium-intensity obstacle lights, Type A, by day and its height above the level of the surrounding ground does not exceed 150 m;
  - (iii) The marking may be omitted when the obstacle is lighted by high-intensity obstacle lights by day; and
  - (iv) The lighting may be omitted where the obstacle is a lighthouse, and an aeronautical study indicates the lighthouse light to be sufficient.

---

## GACAR PART 139 – CERTIFICATION, AUTHORIZATION AND OPERATION OF AERODROMES

---

- (5) A fixed object, other than an obstacle, adjacent to a take-off climb surface must be marked and, if the runway is used at night, lighted if such marking and lighting is considered necessary to ensure its avoidance, except that the marking may be omitted when:
- (i) The object is lighted by medium-intensity obstacle lights Type A, by day and its height above the level of the surrounding ground does not exceed 150 m; or
  - (ii) The object is lighted by high-intensity obstacle lights by day.
- (6) A fixed obstacle that extends above an approach surface within 3,000 m of the inner edge or above a transitional surface must be marked and, if the runway is used at night, lighted, except that:
- (i) Such marking and lighting may be omitted when the obstacle is shielded by another fixed obstacle;
  - (ii) The marking may be omitted when the obstacle is lighted by medium-intensity obstacle lights, Type A, by day and its height above the level of the surrounding ground does not exceed 150 m;
  - (iii) The marking may be omitted when the obstacle is lighted by high-intensity obstacle lights by day; and
  - (iv) The lighting may be omitted where the obstacle is a lighthouse, and an aeronautical study indicates the lighthouse light to be sufficient.
- (7) A fixed obstacle that extends above a horizontal surface must be marked and, if the Aerodrome is used at night, lighted except that:
- (i) Such marking and lighting may be omitted when:
    - (A) The obstacle is shielded by another fixed obstacle; or
    - (B) For a circuit extensively obstructed by immovable objects or terrain, procedures have been established to ensure safe vertical clearance below prescribed flight paths; or
    - (C) An aeronautical study shows the obstacle not to be of operational significance;

---

## GACAR PART 139 – CERTIFICATION, AUTHORIZATION AND OPERATION OF AERODROMES

---

- (ii) The marking may be omitted when the obstacle is lighted by medium-intensity obstacle lights, Type A, by day and its height above the level of the surrounding ground does not exceed 150 m;
  - (iii) The marking may be omitted when the obstacle is lighted by high-intensity obstacle lights by day; and
  - (iv) The lighting may be omitted where the obstacle is a lighthouse, and an aeronautical study indicates the lighthouse light to be sufficient.
- (8) A fixed object that extends above an obstacle protection surface must be marked and, if the runway is used at night, lighted.
- (9) Other objects inside the obstacle limitation surfaces must be marked and/or lighted if an aeronautical study indicates that the object could constitute a hazard to aircraft (this includes objects adjacent to visual routes e.g. waterway or highway).
- (10) Overhead wires, cables, etc., crossing a river, waterway, valley or highway must be marked and their supporting towers marked and lighted if an aeronautical study indicated that the wires or cables could constitute a hazard to aircraft.
- (b) Objects outside the lateral boundaries of the obstacle limitation surfaces
- (1) Obstacles in accordance with § 139.405-(b) must be marked and lighted, except that the marking may be omitted when the obstacle is lighted by high-intensity obstacle lights by day.
  - (2) Other objects outside the obstacle limitation surfaces must be marked and/or lighted if an aeronautical study indicates that the object could constitute a hazard to aircraft (this includes objects adjacent to visual routes e.g., waterway, highway).
  - (3) Overhead wires, cables, etc., crossing a river, waterway, valley, or highway must be marked and their supporting towers marked and lighted if an aeronautical study indicates that the wires or cables could constitute a hazard to aircraft.

### § 139.603 Marking and/or lighting of objects

(a) General

- (1) The presence of objects which must be lighted, as specified in § 139.601, must be indicated by low-, medium- or high-intensity obstacle lights, or a combination of such lights.

## **GACAR PART 139 – CERTIFICATION, AUTHORIZATION AND OPERATION OF AERODROMES**

---

- (2) Low-intensity obstacle lights, Types A, B, C, D and E, medium-intensity obstacle lights, types A, B and C, high-intensity obstacle lights Type A and B, must be in accordance with the specifications in Table I-1 and Appendix H.
- (3) The number and arrangement of low-, medium- or high-intensity obstacle lights at each level to be marked must be such that the object is indicated from every angle in azimuth. Where a light is shielded in any direction by another part of the object, or by an adjacent object, additional lights must be provided on that adjacent object or the part of the object that is shielding the light, in such a way as to retain the general definition of the object to be lighted. If the shielded light does not contribute to the definition of the object to be lighted, it may be omitted.

### (b) Mobile objects

#### (1) Marking

All mobile objects to be marked must be colored or display flags.

#### (2) Marking by color

When mobile objects are marked by color, a single conspicuous color, preferably red or yellowish green for emergency vehicles and yellow for service vehicles must be used.

#### (3) Marking by flags

- (i) Flags used to mark mobile objects must be displayed around, on top of, or around the highest edge of, the object. Flags must not increase the hazard presented by the object they mark.
- (ii) Flags used to mark mobile objects must not be less than 0.9 m on each side and must consist of a checkered pattern, each square having sides of not less than 0.3 m. The colors of the pattern must contrast each with the other and with the background against which they will be seen. Orange and white or alternatively red and white must be used, except where such colors merge with the background.



## GACAR PART 139 – CERTIFICATION, AUTHORIZATION AND OPERATION OF AERODROMES

| 1   | 2                      | 3                            | 4   | 5   | 6  | 7                        |
|---|------------------------|------------------------------|---|---|--|--------------------------|
| Light Type                                    | Color                  | Signal type/<br>(Flash rate) | Peak intensity (cd) at given Background Luminance |   |  | Light Distribution Table |
|   |                        |                              | Day<br>(Above 500<br>cd/m <sup>2</sup> )          | Twilight<br>(50-500 cd/<br>m <sup>2</sup> ) | Night<br>(Below 50<br>cd/ m <sup>2</sup> ) |                          |
| Low-intensity,<br>Type A (fixed<br>obstacle)  | Red                    | Fixed                        | N/A   | N/A   | 10   | Table F-2                |
| Low-intensity,<br>Type B (fixed<br>obstacle)  | Red                    | Fixed                        | N/A   | N/A   | 32   | Table F-2                |
| Low-intensity,<br>Type C (mobile<br>obstacle) | Yellow/<br>Blue<br>(a) | Flashing<br>(60-90 fpm)      | N/A   | 40  | 40   | Table F-2                |
| Low-intensity,<br>Type D<br>Follow-me vehicle | Yellow                 | Flashing<br>(60-90 fpm)      | N/A   | 200   | 200  | Table F-2                |
| Medium-intensity,<br>Type A                   | White                  | Flashing<br>(20-60 fpm)      | 20 000  | 20 000                                      | 2 000                                      | Table F-3                |
| Medium-Intensity<br>Type B                    | Red                    | Flashing<br>(20-60 fpm)      | N/A   | N/A   | 2 000                                      | Table F-3                |
| Medium-intensity,<br>Type C                   | Red                    | Fixed                        | N/A   | N/A   | 2 000                                      | Table F-3                |
| High-intensity,<br>Type A                     | White                  | Flashing<br>(40-60 fpm)      | 200 000   | 20 000                                      | 2 000                                      | Table F-3                |
| High-intensity,<br>Type B                     | White                  | Flashing<br>(40-60 fpm)      | 100 000   | 20 000                                      | 2 000                                      | Table F-3                |

**Table I-1. Characteristics of obstacle lights.**

## GACAR PART 139 – CERTIFICATION, AUTHORIZATION AND OPERATION OF AERODROMES

|        | Minimum intensity (a) | Maximum intensity (a) | Vertical beam spread (f) |           |
|--------|-----------------------|-----------------------|--------------------------|-----------|
|        |                       |                       | Minimum beam spread      | Intensity |
| Type A | 10cd (b)              | N/A                   | 10°                      | 5cd       |
| Type B | 32cd (b)              | N/A                   | 10°                      | 16cd      |
| Type C | 40cd (b)              | 400cd                 | 12° (d)                  | 20cd      |
| Type D | 200cd (c)             | 400cd                 | N/A (e)                  | N/A       |

**Table I-2. Light distribution for low intensity obstacle lights**

*Note. This table does not include recommended horizontal beam spreads. § 139.603-(a)-(3) requires 360° coverage around an obstacle. Therefore, the number of lights needed to meet this requirement will depend on the horizontal beam spreads of each light as well as the shape of the obstacle. Thus, with narrower beam spreads, more lights will be required.*

*(a) 360° horizontal. For flashing lights, the intensity is read into effective intensity, as determined in accordance with the Aerodrome Design Manual, Part 4.*

*(b) Between 2 and 10° vertical. Elevation vertical angles are referenced to the horizontal when the light is leveled.*

*(c) Between 2 and 20° vertical. Elevation vertical angles are referenced to the horizontal when the light is leveled.*

*(d) Peak intensity must be located at approximately 2.5° vertical.*

*(e) Peak intensity must be located at approximately 17° vertical.*

## GACAR PART 139 – CERTIFICATION, AUTHORIZATION AND OPERATION OF AERODROMES

(f) *Beam spread is defined as the angle between the horizontal plan and the directions for which the intensity exceeds that mentioned in the “intensity” column.*

| Benchmark intensity | Minimum requirements          |                       |                       |                          |               | Requirements                 |                       |                       |                          |               |
|---------------------|-------------------------------|-----------------------|-----------------------|--------------------------|---------------|------------------------------|-----------------------|-----------------------|--------------------------|---------------|
|                     | Vertical elevation angle (b)  |                       |                       | Vertical beam spread (c) |               | Vertical elevation angle (b) |                       |                       | Vertical beam spread (c) |               |
|                     | 0°                            |                       | -1°                   |                          |               | 0°                           | -1°                   | -10°                  |                          |               |
|                     | Minimum average intensity (a) | Minimum intensity (a) | Minimum intensity (a) | Minimum beam spread      | Intensity (a) | Maximum intensity (a)        | Maximum intensity (a) | Maximum intensity (a) | Maximum beam spread      | Intensity (a) |
| 200 000             | 200 000                       | 150 000               | 75 000                | 3°                       | 75 000        | 250 000                      | 112 500               | 7 500                 | 7°                       | 75 000        |
| 100 000             | 100 000                       | 75 000                | 37 500                | 3°                       | 37 500        | 125 000                      | 56 250                | 3 750                 | 7°                       | 37 500        |
| 20 000              | 20 000                        | 15 000                | 7 500                 | 3°                       | 7 500         | 25 000                       | 11 250                | 750                   | N/A                      | N/A           |
| 2 000               | 2 000                         | 1 500                 | 750                   | 3°                       | 750           | 2 500                        | 1 125                 | 75                    | N/A                      | N/A           |

**Table I-3. Light distribution for medium and high intensity obstacle lights according to benchmark intensities of table F-1.**

*Note. This table does not include recommended horizontal beam spreads. § 139.603-(a)-(3) requires 360° coverage around an obstacle. Therefore, the number of lights needed to meet this requirement will depend on the horizontal beam spreads of each light as well as the shape of the obstacle. Thus, with narrower beam spreads, more lights will be required.*

(a) *360° horizontal. All intensities are expressed in Candela. For flashing lights, the intensity is read into effective intensity.*

(b) *Elevation vertical angles are referenced to the horizontal when the light unit is leveled.*

(c) *Beam spread is defined as the angle between the horizontal plan and the directions for which the intensity exceeds that mentioned in the “intensity” column.*

*Note. An extended beam spread may be necessary under specific configuration and justified by an aeronautical study.*

---

## GACAR PART 139 – CERTIFICATION, AUTHORIZATION AND OPERATION OF AERODROMES

---

### (4) Lighting

- (i) Low-intensity obstacle lights, Type C, must be displayed on vehicles and other mobile objects excluding aircraft.
- (ii) Low-intensity obstacle lights, Type C, displayed on vehicles associated with emergency or security must be flashing-blue and those displayed on other vehicles must be flashing-yellow.
- (jj) Low-intensity obstacle lights, Type D, must be displayed on follow-me vehicles.
- (iv) Low-intensity obstacle lights on objects with limited mobility such as aerobridges must be fixed-red, and as a minimum be in accordance with the specifications for low-intensity obstacle lights, type A, in table I-1. The intensity of the lights must be sufficient to ensure conspicuity considering the intensity of the adjacent lights and the general levels of illumination against which they would normally be viewed.

### (c) Fixed objects

Note. The fixed objects of wind turbines are addressed separately in § 139.603-(d) and the fixed objects of overhead wires, cables, etc. and supporting towers are addressed separately in § 139.603-(e).

#### (1) Marking

All fixed objects to be marked must, whenever practicable, be colored, but if this is not practicable, markers or flags must be displayed on or above them, except that objects that are sufficiently conspicuous by their shape, size or color need not be otherwise marked.

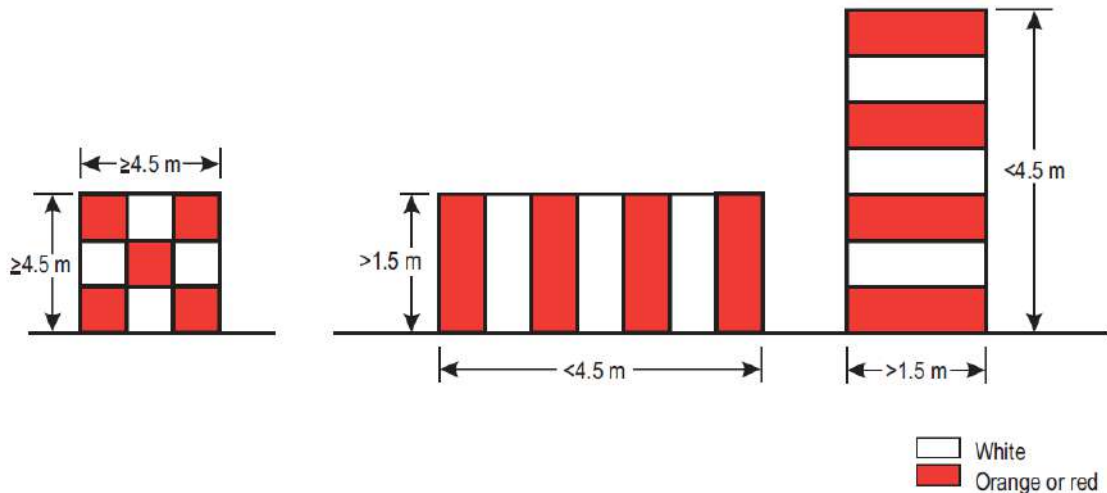
#### (2) Marking by color

- (i) An object must be colored to show a checkered pattern if it has essentially unbroken surfaces and its projection on any vertical plane equals or exceeds 4.5 m in both dimensions. The pattern must consist of rectangles of not less than 1.5 m and not more than 3 m on a side, the corners being of the darker color. The colors of the pattern must contrast each with the other and with the background against which they will be seen. Orange and white or alternatively red and white must be used, except where such colors merge with the background. (See Figure I-1).
- (ii) An object must be colored to show alternating contrasting bands if:

## GACAR PART 139 – CERTIFICATION, AUTHORIZATION AND OPERATION OF AERODROMES

- (A) It has essentially unbroken surfaces and has one dimension, horizontal or vertical, greater than 1.5 m, and the other dimension, horizontal or vertical, less than 4.5 m; or
- (B) It is of skeletal type with either a vertical or a horizontal dimension greater than 1.5 m.

The bands must be perpendicular to the longest dimension and have a width approximately 1/7 of the longest dimension or 30 m, whichever is less. The colors of the bands must contrast with the background against which they will be seen. Orange and white must be used, except where such colors are not conspicuous when viewed against the background. The bands on the extremities of the object must be of the darker color. (See Figures I-1 and I-2)



**Figure I-1. Basic Marking Patterns**

## GACAR PART 139 – CERTIFICATION, AUTHORIZATION AND OPERATION OF AERODROMES

| Longest dimension   |                         |                           |
|---------------------|-------------------------|---------------------------|
| Greater than<br>(m) | Not<br>exceeding<br>(m) | Band width                |
| 1.5                 | 210                     | 1/7 of longest dimension  |
| 210                 | 270                     | 1/9 of longest dimension  |
| 270                 | 330                     | 1/11 of longest dimension |
| 330                 | 390                     | 1/13 of longest dimension |
| 390                 | 450                     | 1/15 of longest dimension |
| 450                 | 210                     | 1/17 of longest dimension |
| 510                 | 570                     | 1/19 of longest dimension |
| 570                 | 630                     | 1/21 of longest dimension |

**Table I-4. Marking band width**

- (iii) An object must be colored in a single conspicuous color if its projection on any vertical plane has both dimensions less than 1.5 m. Orange or red must be used, except where such colors merge with the background.
- (3) Marking by flags
  - (i) Flags used to mark fixed objects must be displayed around, on top of, or around the highest edge of the object. When flags are used to mark extensive objects or a group of closely spaced objects, they must be displayed at least every 15 m. Flags must not increase the hazard presented by the object they mark.

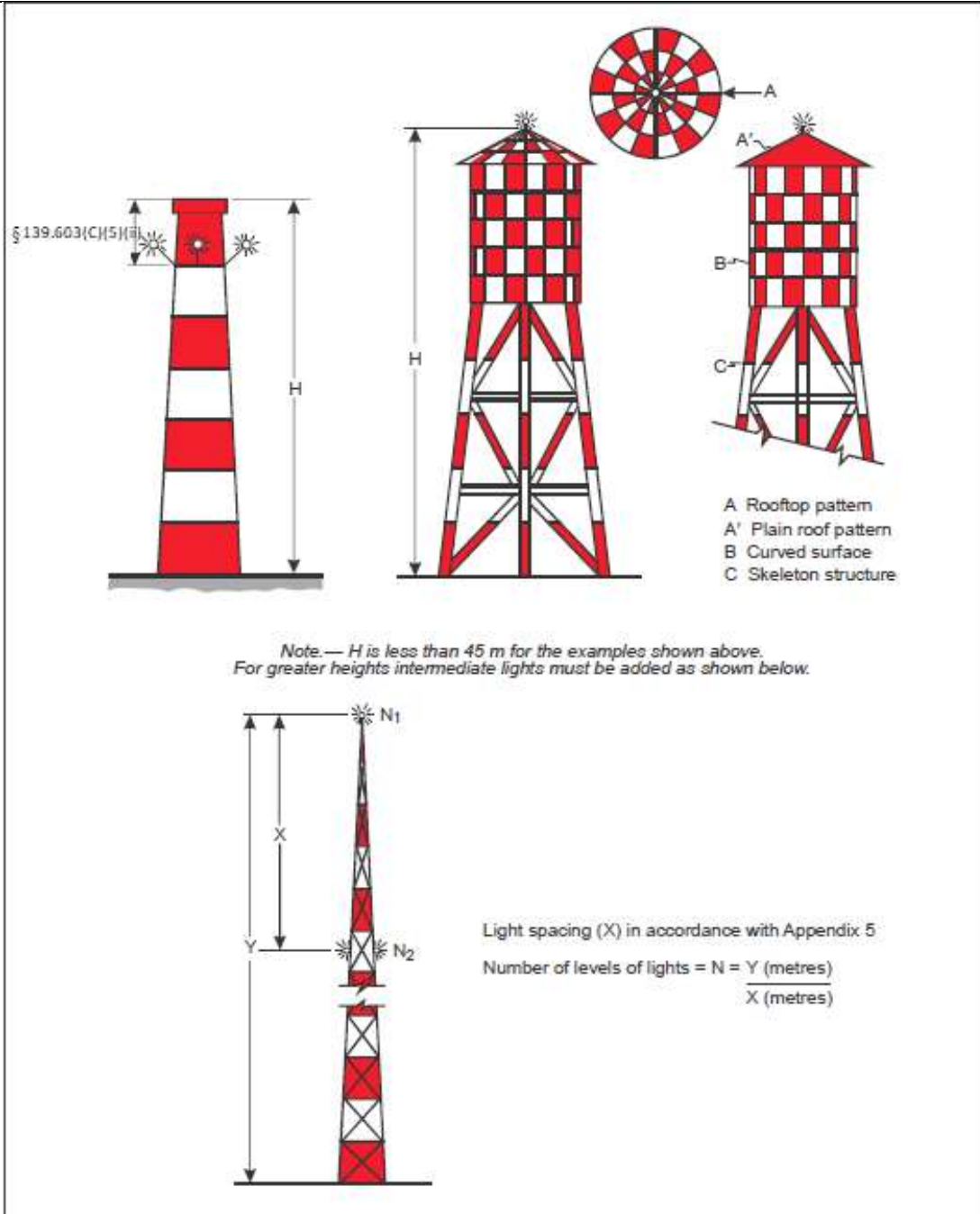
---

## GACAR PART 139 – CERTIFICATION, AUTHORIZATION AND OPERATION OF AERODROMES

---

- (ii) Flags used to mark fixed objects must not be less than 0.6 m on each side.
- (iii) Flags used to mark fixed objects must be orange in color or a combination of two triangular sections, one orange and the other white, or one red and the other white, except that where such colors merge with the background, other conspicuous colors must be used.
- (4) Marking by markers
  - (i) Markers displayed on or adjacent to objects must be located in conspicuous positions so as to retain the general definition of the object and must be recognizable in clear weather from a distance of at least 1,000 m for an object to be viewed from the air and 300 m for an object to be viewed from the ground in all directions in which an aircraft is likely to approach the object. The shape of markers must be distinctive to the extent necessary to ensure that they are not mistaken for markers employed to convey other information, and they must be such that the hazard presented by the object they mark is not increased.
  - (ii) A marker must be of one color. When installed, white and red, or white and orange markers must be displayed alternately. The color selected must contrast with the background against which it will be seen.

## GACAR PART 139 – CERTIFICATION, AUTHORIZATION AND OPERATION OF AERODROMES



**Figure I-2. Examples of Marking and lighting of all structures.**



---

## GACAR PART 139 – CERTIFICATION, AUTHORIZATION AND OPERATION OF AERODROMES

---

(5) Lighting

- (i) In case of an object to be lighted one or more low-, medium- or high-intensity obstacle lights must be located as close as practicable to the top of the object. Requirements on how a combination of low-, medium-, and/or high-intensity lights on obstacles must be displayed are given in Appendix I.
- (ii) In the case of chimney or other structure of like function, the top lights must be placed sufficiently below the top so as to minimize contamination by smoke etc. (see figure I-2).
- (iii) In the case of a tower or antenna structure indicated by high-intensity obstacle lights by day with an appurtenance, such as a rod or an antenna, greater than 12 m where it is not practicable to locate a high-intensity obstacle light on the top of the appurtenance, such a light must be located at the highest practicable point and, if practicable, a medium-intensity obstacle light, Type A, mounted on the top
- (iv) In the case of an extensive object or of a group of closely spaced objects to be lighted that are:
  - (A) Penetrating a horizontal OLS or located outside an OLS, the top lights must be so arranged as to at least indicate the points or edges of the object highest in relation to the obstacle limitation surface or above the ground, and so as to indicate the general definition and the extent of the objects; and
  - (B) Penetrating a sloping OLS the top lights must be so arranged as to at least indicate the points or edges of the object highest in relation to the obstacle limitation surface, and so as to indicate the general definition and the extent of the objects. If two or more edges are of the same height, the edge nearest the landing area must be marked.
- (v) When the obstacle limitation surface concerned is sloping and the highest point above the obstacle limitation surface is not the highest point of the object, additional obstacle lights must be placed on the highest point of the object.
- (vi) Where lights are applied to display the general definition of an extensive object or a group of closely spaced objects, and
  - (A) Low-intensity lights are used; they must be spaced at longitudinal intervals not exceeding 45 m.

---

## GACAR PART 139 – CERTIFICATION, AUTHORIZATION AND OPERATION OF AERODROMES

---

- (B) Medium-intensity lights are used; they must be spaced at longitudinal intervals not exceeding 900 m.
  - (vii) High-intensity obstacle lights, Type A, medium-intensity obstacle lights, Types A and B, located on an object must flash simultaneously.
  - (viii) The installation setting angles for high-intensity obstacle lights, Type A, must be in accordance with Table I-5.
  - (ix) Where, in the opinion of the President, the use of high-intensity obstacle lights, Type A, or medium-intensity obstacle lights, Type A, at night may dazzle pilots in the vicinity of an Aerodrome (within approximately 10,000 m radius) or cause significant environmental concerns, a dual obstacle lighting system must be provided. This system must be composed of high-intensity obstacle lights, Type A or medium intensity Type A obstacle lights, as appropriate, for daytime and twilight use and medium-intensity obstacle lights, Type B or C, for night-time use.
- (6) Lighting of objects with a height less than 45m above ground level
- (i) Low-intensity obstacle lights, Type A or B, must be used where the object is a less extensive one and its height above the surrounding ground is less than 45 m.
  - (ii) Where the use of low-intensity obstacle lights, Type A or B, would be inadequate or an early special warning is required, then medium- or high-intensity obstacle lights must be used.
  - (iii) Low-intensity Type B obstacle lights must be used either alone or in combination with medium-intensity obstacle lights, Type B, in accordance with § 139.603-(c)-(6)-(IV).
  - (iv) Medium-intensity obstacle lights, Type A, B or C, must be used where the object is an extensive one. Medium-intensity obstacle lights, Types A and C, must be used alone, whereas medium intensity obstacle lights, Type B, must be used either alone or in combination with low-intensity obstacle lights, Type B.
- (7) Lighting of objects with a height 45 m to a height less than 150 m above ground level
- (i) Medium-intensity obstacle lights, Type A, B or C, must be used. Medium-intensity obstacle lights, Types A and C, must be used alone, whereas medium intensity obstacle lights, Type B, must be used either alone or in combination with low-intensity obstacle lights, Type B.

---

## GACAR PART 139 – CERTIFICATION, AUTHORIZATION AND OPERATION OF AERODROMES

---

- (ii) Where an object is indicated by medium-intensity obstacle lights, Type A, and the top of the object is more than 105 m above the level of the surrounding ground or the elevation of tops of nearby buildings (when the object to be marked is surrounded by buildings), additional lights must be provided at intermediate levels. These additional intermediate lights must be spaced as equally as practicable, between the top lights and ground level or the level of tops of nearby buildings, as appropriate, with the spacing not exceeding 105 m.
  - (iii) Where an object is indicated by medium-intensity obstacle lights, Type B, and the top of the object is more than 45 m above the level of the surrounding ground or the elevation of tops of nearby buildings (when the object to be marked is surrounded by buildings), additional lights must be provided at intermediate levels. These additional intermediate lights must be alternately low-intensity obstacle lights, Type B, and medium-intensity obstacle lights, Type B, and must be spaced as equally as practicable between the top lights and ground level or the level of tops of nearby buildings, as appropriate, with the spacing not exceeding 52 m.
  - (iv) Where an object is indicated by medium-intensity obstacle lights, Type C, and the top of the object is more than 45 m above the level of the surrounding ground or the elevation of tops of nearby buildings (when the object to be marked is surrounded by buildings), additional lights must be provided at intermediate levels. These additional intermediate lights must be spaced as equally as practicable between the top lights and ground level or the level of tops of nearby buildings, as appropriate, with the spacing not exceeding 52 m.
  - (v) Where high-intensity obstacle lights, Type A, are used, they must be spaced at uniform intervals not exceeding 105 m between the ground level and the top light(s) specified in § 139.603-(c)-(5)-(i) except that where an object to be marked is surrounded by buildings, the elevation of the tops of the buildings may be used as the equivalent of the ground level when determining the number of light levels.
- (8) Lighting of objects with a height 150 m or more above ground level
- (i) High-intensity obstacle lights, Type A, must be used to indicate the presence of an object if its height above the level of the surrounding ground exceeds 150 m and an aeronautical study indicates such lights to be essential for the recognition of the object by day.
  - (ii) Where high-intensity obstacle lights, Type A, are used, they must be spaced at uniform intervals not exceeding 105 m between the ground level and the top light(s) specified

---

## GACAR PART 139 – CERTIFICATION, AUTHORIZATION AND OPERATION OF AERODROMES

---

in § 139.603-(c)-(5)-(i) except that where an object to be marked is surrounded by buildings, the elevation of the tops of the buildings may be used as the equivalent of the ground level when determining the number of light levels.

- (iii) Where, in the opinion of the President, the use of high-intensity obstacle lights, Type A, at night may dazzle pilots in the vicinity of an Aerodrome (within approximately 10,000 m radius) or cause significant environmental concerns, medium-intensity obstacle lights, Type C, must be used alone, whereas medium-intensity obstacle lights, Type B, must be used either alone or in combination with low-intensity obstacle lights, Type B.
- (iv) Where an object is indicated by medium-intensity obstacle lights, Type A, additional lights must be provided at intermediate levels. These additional intermediate lights must be spaced as equally as practicable, between the top lights and ground level or the level of tops of nearby buildings, as appropriate, with the spacing not exceeding 105 m.
- (v) Where an object is indicated by medium-intensity obstacle lights, Type B, additional lights must be provided at intermediate levels. These additional intermediate lights must be alternately low-intensity obstacle lights, type B, and medium-intensity obstacle lights, type B, and must be spaced as equally as practicable between the top lights and ground level or the level of tops of nearby buildings, as appropriate, with the spacing not exceeding 52 m.
- (vi) Where an object is indicated by medium-intensity obstacle lights, Type C, additional lights must be provided at intermediate levels. These additional intermediate lights must be spaced as equally as practicable, between the top lights and ground level or the level of tops of nearby buildings, as appropriate, with the spacing not exceeding 52 m.

### (d) Wind turbines

A wind turbine must be marked and/or lighted if it is determined to be an obstacle.

#### (1) Markings

The rotor blades, nacelle and upper 2/3 of the supporting mast of wind turbines must be painted white, unless otherwise indicated by an aeronautical study.

#### (2) Lighting

---

## GACAR PART 139 – CERTIFICATION, AUTHORIZATION AND OPERATION OF AERODROMES

---

- (i) When lighting is deemed necessary, medium intensity obstacle lights must be used. In the case of a wind farm, i.e., group of two or more wind turbines it must be regarded as an extensive object and the lights must be installed:
  - (A) To identify the perimeter of the wind farm;
  - (B) Respecting the maximum spacing, in accordance with § 139.603-(c)-(5)-(vi) between the lights along the perimeter, unless a dedicated assessment shows that a greater spacing can be used;
  - (C) So that, where flashing lights are used, they flash simultaneously; and
  - (D) So that, within a wind farm, any wind turbines of significantly higher elevation are also identified wherever they are located; and
  - (E) At locations prescribed in A), B) and D), respecting the following criteria:
    - (I) For wind turbines of less than 150 m in overall height (hub height plus vertical blade height), medium-intensity lighting on the nacelle must be provided;
    - (II) For wind turbines from 150 m to 315 m in overall height, in addition to the medium-intensity light installed on the nacelle, a second light serving as an alternate must be provided in case of failure of the operating light. The lights must be installed to assure that the output of either light is not blocked by the other; and
    - (III) in addition, for wind turbines from 150 m to 315 m in overall height, an intermediate level at half the nacelle height of at least three low-intensity Type E lights, as specified in § 139.603-(a)-(3), must be provided. If an aeronautical study shows that low-intensity Type E lights are not suitable, low-intensity Type A or B lights may be used.
- (ii) The obstacle lights must be installed on the nacelle in such a manner as to provide an unobstructed view for aircraft approaching from any direction.
- (iii) Where lighting is deemed necessary for a single wind turbine or short line of wind turbines, the installation must be in accordance with § 139.603-(d)-(2)-(i)-(E) or as determined by an aeronautical study.

---

## **GACAR PART 139 – CERTIFICATION, AUTHORIZATION AND OPERATION OF AERODROMES**

---

(e) Overhead wires, cables, etc. and supporting towers

(1) Marking

The wires, cables, etc. to be marked must be equipped with markers; the supporting tower must be colored.

(2) Marking by colors

The supporting towers of overhead wires, cables, etc. that require marking must be marked in accordance with § 139.603-(c)-(1) to § 139.603-(c)-(2)-(iii), except that the marking of the supporting towers may be omitted when they are lighted by high-intensity obstacle lights by day.

(3) Marking by markers

- (i) Markers displayed on or adjacent to objects must be located in conspicuous positions so as to retain the general definition of the object and must be recognizable in clear weather from a distance of at least 1,000 m for an object to be viewed from the air and 300 m for an object to be viewed from the ground in all directions in which an aircraft is likely to approach the object. The shape of markers must be distinctive to the extent necessary to ensure that they are not mistaken for markers employed to convey other information, and they must be such that the hazard presented by the object they mark is not increased.
- (ii) A marker displayed on an overhead wire, cable, etc. must be spherical and have a diameter of not less than 60 cm.
- (iii) The spacing between two consecutive markers or between a marker and a supporting tower must be appropriate to the diameter of the marker, but in no case must the spacing exceed:
  - (A) 30 m where the marker diameter is 60 cm progressively increasing with the diameter of the marker to
  - (B) 35 m where the marker diameter is 80 cm and further progressively increasing to a maximum of
  - (C) 40 m where the marker diameter is of at least 130 cm.

## GACAR PART 139 – CERTIFICATION, AUTHORIZATION AND OPERATION OF AERODROMES

Where multiple wires, cables, etc. are involved, a marker must be located not lower than the level of the highest wire at the point marked.

- (iv) A marker must be of one color. When installed, white and red, or white and orange markers must be displayed alternately. The color selected must contrast with the background against which it will be seen.
  - (v) When it has been determined that an overhead wire, cable, etc., needs to be marked but it is not practicable to install markers on the wire, cable, etc., then high-intensity obstacle lights, Type B, must be provided on their supporting towers.
- (4) Lighting
- (i) High intensity obstacle lights, Type B, must be used to indicate the presence of the tower supporting overhead wires, cables, etc. where:
    - (A) An aeronautical study indicates such light to be essential for the recognition of the presence of wires, cables, etc.; or
    - (B) It has not been found practicable to install marker on the wires, cables, etc.
  - (ii) Where high-intensity obstacle lights, Type B, are used, they must be located at three levels:
    - (A) At the top of the tower;
    - (B) At the lowest level of the catenary of the wires or cables; and
    - (C) At approximately midway between these two levels.
  - (iii) High-intensity obstacle lights, Type B, indicating the presence of a tower supporting overhead wires, cables, etc., must flash sequentially; first the middle light, second the top light and last, the bottom light. The intervals between flashes of the lights must be approximate the following ratios:

| Flash interval between  | Ratio of cycle time |
|-------------------------|---------------------|
| Middle and top light    | 1/13                |
| top and bottom light    | 2/13                |
| bottom and middle light | 10/13               |

## GACAR PART 139 – CERTIFICATION, AUTHORIZATION AND OPERATION OF AERODROMES

- (iv) Where, in the opinion of President, the use of high-intensity obstacle lights, Type B, at night may dazzle pilots in the vicinity of an Aerodrome (within approximately 10,000 m radius) or cause significant environmental concerns, a dual obstacle lighting system must be provided. This system must be composed of high-intensity obstacle lights, Type B, for daytime and twilight use and medium-intensity obstacle lights, Type B, for night-time use. Where medium-intensity lights are used they must be installed at the same level as the high-intensity obstacle light Type B.
- (v) The installation setting angles for high-intensity obstacle lights, Type B, must be in accordance with Table F-5.

| Height of light unit<br>above terrain | Angle of the<br>peak of the<br>beam above the<br>horizontal |
|---------------------------------------|---|
| Greater than 151 m<br>AGL             | 0°  |
| 122 m to 151 m AGL                    | 1°  |
| 92 m to 122 m AGL                     | 2°  |
| less than 92 m AGL                    | 3°  |

**Table I-5. Installation setting angles for high-intensity obstacle lights**



---

## GACAR PART 139 – CERTIFICATION, AUTHORIZATION AND OPERATION OF AERODROMES

---

### SUBPART J – VISUAL AIDS FOR DENOTING RESTRICTED USE AREAS

#### § 139.701 Closed runways and taxiways, or parts thereof

(a) Application

- (1) A closed marking must be displayed on a runway or taxiway, or portion thereof, which is permanently closed to the use of all aircraft.
- (2) A closed marking must be displayed on a temporarily closed runway or taxiway or portion thereof, except that such marking may be omitted when the closing is of short duration and adequate warning by air traffic services is provided.

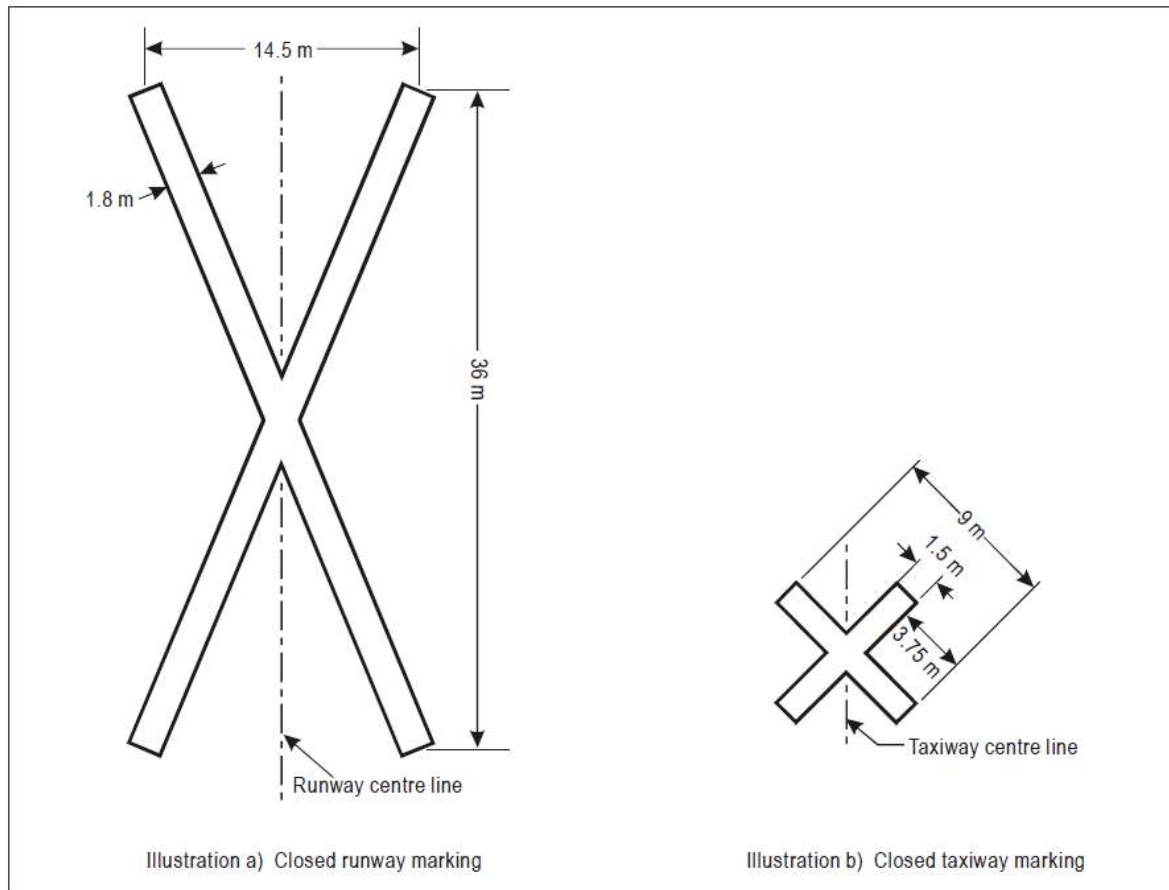
(b) Location

On a runway a closed marking must be placed at each end of the runway, or portion thereof, declared closed, and additional markings must be so placed that the maximum interval between markings does not exceed 300 m. On a taxiway a closed marking must be placed at least at each end of the taxiway or portion thereof closed.

(c) Characteristics

- (1) The closed marking must be of the form and proportions as detailed in Figure J-1, Illustration a) when displayed on a runway, and must be of the form and proportions as detailed in Figure J-1, Illustration b), when displayed on a taxiway. The marking must be white when displayed on a runway and must be yellow when displayed on a taxiway.
- (2) When a runway or taxiway or portion thereof is permanently closed, all normal runway and taxiway markings must be obliterated.
- (3) Lighting on a closed runway or taxiway or portion thereof must not be operated, except as required for maintenance purposes.
- (4) In addition to closed markings, when the runway or taxiway or portion thereof closed is intercepted by a usable runway or taxiway which is used at night, unserviceability lights must be placed across the entrance to the closed area at intervals not exceeding 3 m. (See § 139.707- (d).

## GACAR PART 139 – CERTIFICATION, AUTHORIZATION AND OPERATION OF AERODROMES



**Figure J-1. Closed runway and taxiway markings**

### § 139.703 Non-load-bearing surfaces

#### (a) Application

Shoulders for taxiways, runway turn pads, holding bays and aprons and other non-load-bearing surfaces which cannot readily be distinguished from load-bearing surfaces and which, if used by aircraft, might result in damage to the aircraft must have the boundary between such areas and the load-bearing surface marked by a taxi side stripe marking.

## GACAR PART 139 – CERTIFICATION, AUTHORIZATION AND OPERATION OF AERODROMES

(b) Location

A taxi side stripe marking must be placed along the edge of the load-bearing pavement, with the outer edge of the marking approximately on the edge of the load-bearing pavement.

(c) Characteristics

A taxi side stripe marking must consist of a pair of solid lines, each 15 cm wide and spaced 15 cm apart and the same color as the taxiway centre line marking.

### § 139.705 Pre-threshold area

(a) Application

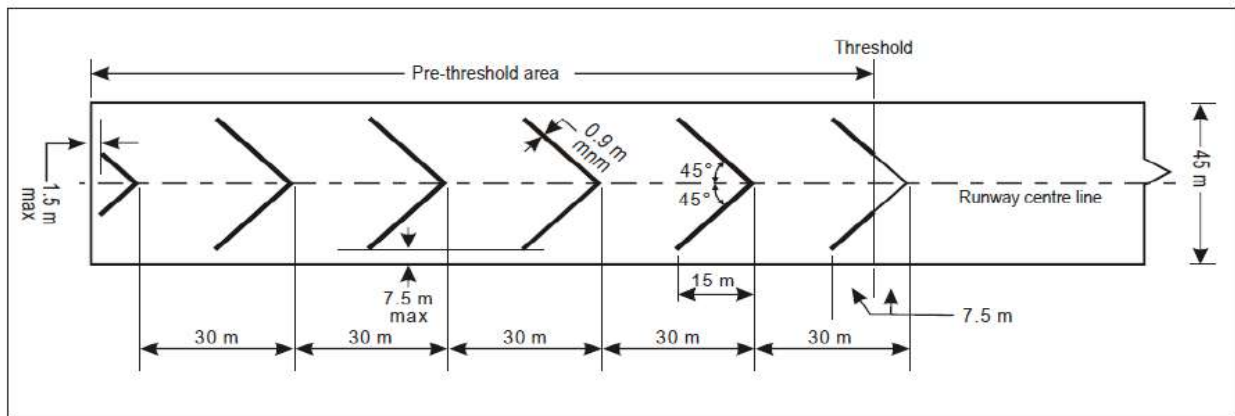
When the surface before a threshold is paved and exceeds 60 m in length and is not suitable for normal use by aircraft, the entire length before the threshold must be marked with a chevron marking.

(b) Location

Chevron marking must point in the direction of the runway and be placed as shown in Figure J-2.

(c) Characteristics

A chevron marking must be of conspicuous color and contrast with the color used for the runway markings; it must preferably be yellow. It must have an over-all width of at least 0.9 m.



**Figure J-2. Pre-threshold marking**

---

## GACAR PART 139 – CERTIFICATION, AUTHORIZATION AND OPERATION OF AERODROMES

---

### § 139.707 Unserviceable areas

(a) Application

Un-serviceability markers must be displayed wherever any portion of a taxiway, apron or holding bay is unfit for the movement of aircraft but it is still possible for aircraft to bypass the area safely. On a movement area used at night, unserviceability lights must be used.

(b) Location

Unserviceability markers and lights must be placed at intervals sufficiently close so as to delineate the unserviceable area.

(c) Characteristics of unserviceability markers

Unserviceability markers must consist of conspicuous upstanding devices such as flags, cones, or marker boards.

(d) Characteristics of unserviceability lights

An unserviceability light must consist of a red fixed light. The light must have intensity sufficient to ensure conspicuity considering the intensity of the adjacent lights and the general level of illumination against which it would normally be viewed. In no case must the intensity be less than 10 cd of red light.

(e) Characteristics of unserviceability cones

An unserviceability cone must be at least 0.5 m in height and red, orange or yellow or any one of these colors in combination with white.

(f) Characteristics of unserviceability flags

An unserviceability flag must be at least 0.5 m square and red, orange or yellow or any one of these colors in combination with white.

(g) Characteristics of unserviceability boards

An unserviceability marker board must be at least 0.5 m in height and 0.9 m in length, with alternate red and white or orange and white vertical stripes.

---

## GACAR PART 139 – CERTIFICATION, AUTHORIZATION AND OPERATION OF AERODROMES

---

### SUBPART K – ELECTRICAL SYSTEMS

#### § 139.801 Electrical power supply systems for air navigation facilities

The safety of operations at aerodromes depends on the quality of the supplied power. The total electrical power supply system may include connections to one or more external sources of electric power supply, one or more local generating facilities and to a distribution network including transformers and switchgear. Many other aerodrome facilities supplied from the same system need to be taken into account while planning the electrical power system at aerodromes.

- (a) Adequate primary power supply must be available at aerodromes for the safe functioning of air navigation facilities.
- (b) The design and provision of electrical power systems for aerodrome visual and radio navigation aids must be such that an equipment failure will not leave the pilot with inadequate visual and non-visual guidance or misleading information.
- (c) Electric power supply connections to those facilities for which secondary power is required must be so arranged that the facilities are automatically connected to the secondary power supply on failure of the primary source of power.
- (d) The time interval between failure of the primary source of power and the complete restoration of the services required by § 139.801-(a)-(1)-(iv) must be as short as practicable, except that for visual aids associated with non-precision, precision approach or take-off runways the requirements of Table K-1 for maximum switch-over times must apply.
- (e) The electric power supply connections to those facilities for which secondary power is required must be so arranged that the facilities are capable of meeting the requirements of Table K-1 for maximum switch-over times.
- (f) Visual aids
  - (1) Application
    - (i) For a precision approach runway, a secondary power supply capable of meeting the requirements of Table K-1 for the appropriate category of precision approach runway must be provided. Electric power supply connections to those facilities for which

---

## GACAR PART 139 – CERTIFICATION, AUTHORIZATION AND OPERATION OF AERODROMES

---

secondary power is required must be so arranged that the facilities are automatically connected to the secondary power supply on failure of the primary source of power.

- (ii) For a runway meant for take-off in runway visual range conditions less than a value of 800 m, a secondary power supply capable of meeting the relevant requirements of Table K-1 must be provided.
- (iii) At an aerodrome where the primary runway is a non-precision approach runway, a secondary power supply capable of meeting the requirements of Table K-1 must be provided except that a secondary power supply for visual aids need not be provided for more than one non-precision approach runway.
- (iv) At an aerodrome where the primary runway is a non-instrument runway, a secondary power supply capable of meeting the requirements of § 139.801-(4) must be provided, except that a secondary power supply for visual aids need not be provided when an emergency lighting system in accordance with the specification of § 139.505-(b) is provided and capable of being deployed in 15 minutes.
- (v) The following aerodrome facilities must be provided with a secondary power supply capable of supplying power when there is a failure of the primary power supply:
  - (A) The signaling lamp and the minimum lighting necessary to enable air traffic services personnel to carry out their duties;
  - (B) All obstacle lights which, in the opinion of the President, are essential to ensure the safe operation of aircraft;
  - (C) Approach, runway and taxiway lighting as specified in § 139.801-(a)-(1)-(i) to § 139.801-(a)-(1)-(iv);
  - (D) Meteorological equipment;
  - (E) Essential security lighting, if provided in accordance with § 139.921;
  - (F) Essential equipment and facilities for the Aerodrome responding emergency agencies;
  - (G) Floodlighting on a designated isolated aircraft parking position if provided in accordance with § 139.505-(u)-(1); and
  - (H) Illumination of apron areas over which passengers may walk.

## GACAR PART 139 – CERTIFICATION, AUTHORIZATION AND OPERATION OF AERODROMES

- (vi) Requirements for a secondary power supply must be met by either of the following:
- (A) Independent public power, which is a source of power supplying the aerodrome service from a substation other than the normal substation through a transmission line following a route different from the normal power supply route and such that the possibility of a simultaneous failure of the normal and independent public power supplies is extremely remote; or
  - (B) Standby power unit(s), which are engine generators, batteries, etc., from which electric power can be obtained.

| Runway                 | Lighting aids requiring power  | Maximum switch-over time   |
|------------------------|--|--|
| Non-Instrument         | Visual approach slope indicators <sup>(a)</sup><br>Runway edge <sup>(b)</sup><br>Runway threshold <sup>(b)</sup><br>Runway end <sup>(b)</sup><br>Obstacle <sup>(a)</sup>                 | See § 139.801-(a)-(1)-(i) and § 139.801-(a)-(1)-(iv)                             |
| Non-precision approach | Approach lighting system<br>Visual approach slope indicators <sup>(a, d)</sup><br>Runway edge <sup>(d)</sup><br>Runway threshold <sup>(d)</sup><br>Runway end<br>Obstacle <sup>(a)</sup> | 15 seconds<br>15 seconds<br>15 seconds<br>15 seconds<br>15 seconds<br>15 seconds |

## GACAR PART 139 – CERTIFICATION, AUTHORIZATION AND OPERATION OF AERODROMES

|   |  |  |
|---|--|--|
| Precision approach Category I               | Approach lighting system                           | 15 seconds                                 |
|   | Runway edge <sup>(d)</sup>                         | 15 seconds                                 |
|   | Visual approach slope indicators <sup>(a, d)</sup> | 15 seconds                                 |
|   | Runway threshold <sup>(d)</sup>                    | 15 seconds                                 |
|   | Runway end   | 15 seconds                                 |
|   | Essential taxiway <sup>(a)</sup>                   | 15 seconds                                 |
|   | Obstacle <sup>(a)</sup>                            | 15 seconds                                 |
|   | Precision approach Category II/III                 | Inner 300m of the approach lighting system |
| Other parts of the approach lighting system |  | 15 seconds                                 |
| Obstacle <sup>(a)</sup>                     |  |  |
| Runway edge <sup>(d)</sup>                  |  | 15 seconds                                 |
| Runway threshold                            |  | 15 seconds                                 |
| Runway end                                  |  | 1 second                                   |
| Runway centre line                          |  | 1 second                                   |
| Runway touchdown zone                       |  | 1 second                                   |
| All stop bars                               |  | 1 second                                   |
| Essential taxiway                           |  | 1 second                                   |
|   | 15 seconds   |  |



## GACAR PART 139 – CERTIFICATION, AUTHORIZATION AND OPERATION OF AERODROMES

|  |                                   |                           |
|--|-----------------------------------|---------------------------|
| Runway meant for take-off in runway visual range conditions less than a value of 800m  | Runway edge                       | 15 seconds <sup>(c)</sup> |
|  | Runway end                        | 1 second                  |
|  | Runway centre line                | 1 second                  |
|  | All stop bars                     | 1 second                  |
|  | Essential taxiways <sup>(a)</sup> | 15 seconds                |
|  | Obstacle <sup>(a)</sup>           | 15 seconds                |
| <p>(a) Supplied with secondary power when their operation is essential to the safety of flight operation.</p> <p>(b) See Subpart E, § 139.505-(b), regarding the use of emergency lighting.</p> <p>(c) One second where no runway centre line lights are provided.</p> <p>(d) One second where approaches are over hazardous or precipitous terrain.</p> |                                   |                           |

**Table K-1. Secondary power supply requirements (See § 139.801-(4))**

### § 139.803 System design

- (a) For a runway meant for use in runway visual range conditions less than a value of 550 m, the electrical systems for the power supply, lighting and control of the lighting systems included in Table K-1 must be so designed that an equipment failure will not leave the pilot with inadequate visual guidance or misleading information.
- (b) Where the secondary power supply of an Aerodrome is provided by the use of duplicate feeders, such supplies must be physically and electrically separate so as to ensure the required level of availability and independence.

---

## GACAR PART 139 – CERTIFICATION, AUTHORIZATION AND OPERATION OF AERODROMES

---

- (c) Where a runway forming part of a standard taxi-route is provided with runway lighting and taxiway lighting, the lighting systems must be interlocked to preclude the possibility of simultaneous operation of both forms of lighting.

### § 139.805 Monitoring

- (a) A system of monitoring must be employed to indicate the operational status of the lighting systems.
- (b) Where lighting systems are used for aircraft control purposes, such systems must be monitored automatically so as to provide an indication of any fault which may affect the control functions. This information must be automatically relayed to the air traffic service unit.
- (c) Where a change in the operational status of lights has occurred, an indication must be provided within two seconds for a stop bar at a runway holding position and within five seconds for all other types of visual aids.
- (d) For a runway meant for use in runway visual range conditions less than a value of 550 m, the lighting systems detailed in Table K-1 must be monitored automatically so as to provide an indication when the serviceability level of any element falls below the minimum serviceability level specified in § 139.1009- (7) to § 139.1009- (11), as appropriate. This information must be automatically relayed to the maintenance crew.
- (e) For a runway meant for use in runway visual range conditions less than a value of 550 m, the lighting systems detailed in Table K-1 must be monitored automatically to provide an indication when the serviceability level of any element falls below the minimum level specified by the President below which operations must not continue. This information must be automatically relayed to the air traffic services unit and displayed in a prominent position.

---

## GACAR PART 139 – CERTIFICATION, AUTHORIZATION AND OPERATION OF AERODROMES

---

### SUBPART L – AERODROME OPERATIONAL SERVICES, EQUIPMENT AND INSTALLATIONS

#### § 139.901 Aerodrome emergency planning

(a) General

- (1) An aerodrome emergency plan must be established at an aerodrome, commensurate with the aircraft operations and other activities conducted at the aerodrome.
- (2) The aerodrome certificate holder must establish an aerodrome emergency planning committee (AEPC). All assigned members from both internal and external (off airport) agencies will be participants in the development, review and exercising of the aerodrome emergency plan.
- (3) Sufficient medical services and supplies must be available at the aerodrome facility to deal with routine medical emergencies, which normally occur at the aerodrome (on-the-job injuries, heart attacks, etc.), plus possible aircraft accidents.
- (4) The aerodrome emergency plan must provide for the coordination of the actions to be taken in an emergency occurring at an aerodrome or in its vicinity.

*Note 1. — Examples of emergencies are aircraft emergencies, sabotage including bomb threats, unlawfully seized aircraft, dangerous goods occurrences, building fires, natural disaster and public health emergencies.*

*Note 2. — Examples of public health emergencies are increased risk of travelers or cargo spreading a serious communicable disease internationally through air transport and severe outbreak of a communicable disease potentially affecting a large proportion of Aerodrome staff.*

- (5) The plan must coordinate the response or participation of all existing agencies which, in the opinion of the President, could be of assistance in responding to an emergency.

*Note 1. — Examples of agencies are:*

*— on the Aerodrome: air traffic control units, rescue and firefighting services, Aerodrome administration, medical and ambulance services, aircraft operators, security services, and police;*

---

## GACAR PART 139 – CERTIFICATION, AUTHORIZATION AND OPERATION OF AERODROMES

---

— *off the Aerodrome: fire departments, police, health authorities (including medical, ambulance, hospital and public health services), military, and harbor patrol or coast guard.*

*Note 2. — Public health services include planning to minimize adverse effects to the community from health-related events and deal with population health issues rather than provision of health services to individuals.*

- (6) The plan must provide for cooperation and coordination with the rescue coordination center, as necessary.
- (7) The aerodrome emergency plan document must include at least the following:
  - (i) Types of emergencies planned for;
  - (ii) Agencies involved in the plan;
  - (iii) Responsibility and role of each agency, the emergency operations center, and the command post, for each type of emergency;
  - (iv) Information on names and telephone numbers of offices or people to be contacted in the case of a particular emergency; and
  - (v) A grid map of the aerodrome and its immediate vicinity.
- (8) The plan must observe Human Factors principles to ensure optimum response by all existing agencies participating in emergency operations.

(b) Emergency operations centre and command post

- (1) A fixed emergency operations center and a mobile command post must be available for use during an emergency.
- (2) The emergency operations center must be a part of the Aerodrome facilities and must be responsible for the overall coordination and general direction of the response to an emergency.
- (3) The command post must be a facility capable of being moved rapidly to the site of an emergency, when required, and must undertake the local coordination of those agencies responding to the emergency.

---

## GACAR PART 139 – CERTIFICATION, AUTHORIZATION AND OPERATION OF AERODROMES

---

- (4) A person must be assigned to assume control of the emergency operations center and, when appropriate, another person the command post.

(c) Communication system

Adequate communication systems linking the command post and the emergency operations center with each other and with the participating agencies must be provided in accordance with the plan and consistent with the particular requirements of the Aerodrome.

(d) Aerodrome emergency exercise

- (1) The plan must contain procedures for periodic testing of the adequacy of the plan and for reviewing the results in order to improve its effectiveness.
- (2) The plan must be tested by conducting:
- (i) A full-scale aerodrome emergency exercise at intervals not exceeding two years and partial emergency exercises in the intervening year to ensure that any deficiencies found during the full-scale aerodrome emergency exercise have been corrected; or A series of modular tests commencing in the first year and concluding in a full-scale aerodrome emergency exercise at intervals not exceeding three years; and reviewed thereafter, or after an actual emergency, so as to correct any deficiency found during such exercises or actual emergency.
  - (ii) A Tabletop exercise must be conducted at least once each six months, except during that six-month period when a full-scale exercise is held.
  - (iii) At least 120 days prior to the scheduled full-scale emergency exercise, the aerodrome certificate holder must hold a meeting of all emergency planning committee. At this time, the aims of the exercise must be outlined, a scenario formulated, work tasks assigned, and duties of all agencies and personnel defined. And notify GACA concern department in formats and manner acceptable to the President.

(e) Emergencies in difficult environments

- (1) The plan must include the ready availability of and coordination with appropriate specialist rescue services to be able to respond to emergencies where an aerodrome is located close to water and/or swampy areas and where a significant portion of approach or departure operations takes place over these areas.
- (2) At those aerodromes located close to water and/or swampy areas, or difficult terrain, the aerodrome emergency plan must include the establishment, testing and assessment at regular intervals of a pre-determined response for the specialist rescue services.

---

## GACAR PART 139 – CERTIFICATION, AUTHORIZATION AND OPERATION OF AERODROMES

---

- (3) An assessment of the approach and departure areas within 1,000 m of the runway threshold must be carried out to determine the options available for intervention.

### § 139.903 Rescue and fire fighting

(a) Application

- (1) Rescue and firefighting equipment and services must be provided at an aerodrome when serving commercial air transport operation.
- (2) Where an aerodrome is located close to water/swampy areas, or difficult terrain, and where a significant portion of approach or departure operations takes place over these areas, specialist rescue services and firefighting equipment appropriate to the hazard and risk must be available.

(b) Level of protection to be provided

- (1) The level of protection provided at an Aerodrome for rescue and firefighting must be appropriate to the aerodrome category determined using the principles in § 139.903-(b)-(3) and § 139.903-(b)-(4), except that, where the number of movements of the aeroplanes in the highest category normally using the aerodrome is less than 700 in the busiest consecutive three months, the level of protection provided must be not less than one category below the determined category.
- (2) The level of protection provided at an Aerodrome for rescue and firefighting must be equal to the aerodrome category determined using the principles in § 139.903-(b)-(3) and § 139.903-(b)-(4).
- (3) The aerodrome category must be determined from Table L-1 and must be based on the longest aeroplanes normally using the aerodrome and their fuselage width.
- (4) If, after selecting the category appropriate to the longest airplane's overall length, that airplane's fuselage width is greater than the maximum width in Table L-1, column 3 for that category, then the category for that aeroplane must actually be one category higher.

*Note 1. — See guidance in the Airport Services Manual (Doc 9137), Part 1, for categorizing aerodromes, including those for all-cargo aircraft operations, for rescue and firefighting purposes.*

- (5) During anticipated periods of reduced activity, the level of protection available must be no less than that needed for the highest category of aeroplane planned to use the Aerodrome during that time irrespective of the number of movements.

## GACAR PART 139 – CERTIFICATION, AUTHORIZATION AND OPERATION OF AERODROMES

| Aerodrome Category<br>(1) | Aeroplane Overall Length<br>(2)   | Maximum fuselage width<br>(3) |
|---------------------------|-----------------------------------|-------------------------------|
| 1                         | 0 m up to but not including 9 m   | 2 m                           |
| 2                         | 9 m up to but not including 12 m  | 2 m                           |
| 3                         | 12 m up to but not including 18 m | 3 m                           |
| 4                         | 18 m up to but not including 24 m | 4 m                           |
| 5                         | 24 m up to but not including 28 m | 4 m                           |
| 6                         | 28 m up to but not including 39 m | 5 m                           |
| 7                         | 39 m up to but not including 49 m | 5 m                           |
| 8                         | 49 m up to but not including 61 m | 7 m                           |
| 9                         | 61 m up to but not including 76 m | 7 m                           |
| 10                        | 76 m up to but not including 90 m | 8 m                           |

**Table L-1. Aerodrome Category for Rescue and fire fighting**

(c) Extinguishing agents

- (1) Both principal and complementary agents must normally be provided at an aerodrome.
- (2) The principal extinguishing agent must be:
  - (i) A foam meeting the minimum performance level A; or
  - (ii) A foam meeting the minimum performance level B; or
  - (iii) A foam meeting the minimum performance Level C; or
  - (iv) A combination of these agents;

## GACAR PART 139 – CERTIFICATION, AUTHORIZATION AND OPERATION OF AERODROMES

Except that the principal extinguishing agent for aerodromes in categories 1 to 3 should preferably meet a performance level B or C foam.

- (3) Unless authorized by the President, the complementary extinguishing agent must be a dry chemical powder suitable for extinguishing hydrocarbon fires.
- (4) The amounts of water for foam production and the complementary agents to be provided on the rescue and fire fighting vehicles must be in accordance with the aerodrome category determined under § 139.903-(c)-(1), § 139.903-(c)-(2), § 139.903-(c)-(3), § 139.903-(c)-(4) and Table I-2, except that for aerodrome categories 1 and 2 up to 100 per cent of the water may be substituted by complementary agent.

For the purpose of agent substitution, 1 kg of complementary agent must be taken as equivalent to 1.0 L of water for production of a foam meeting performance level A.

- (i) The amounts of water specified for foam production are predicated on an application rate of 8.2 L/min/m<sup>2</sup> for a foam meeting performance level A, 5.5 L/min/m<sup>2</sup> for a foam meeting performance level B and 3.75 L/min/m<sup>2</sup> for a foam meeting performance level C.

| Aerodrome category | Foam meeting performance level A |                                     | Foam meeting performance level B |                                     | Foam meeting performance level C |                                     | Complementary agents      |                            |
|--------------------|----------------------------------|-------------------------------------|----------------------------------|-------------------------------------|----------------------------------|-------------------------------------|---------------------------|----------------------------|
|                    | Water (L)                        | Discharge rate foam solution/minute | Water (L)                        | Discharge rate foam solution/minute | Water (L)                        | Discharge rate foam solution/minute | Dry chemical powders (kg) | Discharge Rate (kg/second) |
|                    |                                  | (L)                                 |                                  | (L)                                 |                                  | (L)                                 |                           |                            |
| (1)                | (2)                              | (3)                                 | (4)                              | (5)                                 | (6)                              | (7)                                 | (8)                       | (9)                        |
| 1                  | 350                              | 350                                 | 230                              | 230                                 | 160                              | 160                                 | 45                        | 2.25                       |
| 2                  | 1 000                            | 800                                 | 670                              | 550                                 | 460                              | 360                                 | 90                        | 2.25                       |
| 3                  | 1 800                            | 1 300                               | 1 200                            | 900                                 | 820                              | 630                                 | 135                       | 2.25                       |
| 4                  | 3 600                            | 2 600                               | 2 400                            | 1 800                               | 1 700                            | 1 100                               | 135                       | 2.25                       |
| 5                  | 8 100                            | 4 500                               | 5 400                            | 3 000                               | 3 900                            | 2 200                               | 180                       | 2.25                       |
| 6                  | 11 800                           | 6 000                               | 7 900                            | 4 000                               | 5 800                            | 2 900                               | 225                       | 2.25                       |
| 7                  | 18 200                           | 7 900                               | 12 100                           | 5 300                               | 8 800                            | 3 800                               | 225                       | 2.25                       |
| 8                  | 27 300                           | 10 800                              | 18 200                           | 7 200                               | 12 800                           | 5 100                               | 450                       | 4.5                        |
| 9                  | 36 400                           | 13 500                              | 24 300                           | 9 000                               | 17 100                           | 6 300                               | 450                       | 4.5                        |
| 10                 | 48 200                           | 16 600                              | 32 300                           | 11 200                              | 22 800                           | 7 900                               | 450                       | 4.5                        |

*Note.— The quantities of water shown in columns 2, 4 and 6 are based on the average overall length of aeroplanes in a given category.*

**Table L-2. Minimum usable amounts of extinguishing agents**

- (5) At aerodromes where operation by aeroplanes larger than the average size in a given category are planned, the quantities of water must be recalculated and the amount of water



---

## GACAR PART 139 – CERTIFICATION, AUTHORIZATION AND OPERATION OF AERODROMES

---

- for foam production and the discharge rates for foam solution must be increased accordingly.
- (6) The quantity of foam concentrates separately provided on vehicles for foam production must be in proportion to the quantity of water provided and the foam concentrate selected.
  - (7) The amount of foam concentrate provided on a vehicle must be sufficient to produce at least two loads of foam solution.
  - (8) Supplementary water supplies, for the expeditious replenishment of rescue and fire fighting vehicles at the scene of an aircraft accident, must be provided.
  - (9) When a combination of different performance level foams is provided at an Aerodrome, the total amount of water to be provided for foam production must be calculated for each foam type and the distribution of these quantities should be documented for each vehicle and applied to the overall rescue and firefighting requirement.
  - (10) The discharge rate of the foam solution must not be less than the rates shown in Table L-2.
  - (11) The complementary agents must comply with the appropriate specifications of the International Organization for Standardization (ISO).
  - (12) The discharge rate of complementary agents must be no less than the values shown in Table L-2.
  - (13) Dry chemical powders must only be substituted with an agent that has equivalent or better firefighting capabilities for all types of fires where complementary agent is expected to be used.
  - (14) A reserve supply of foam concentrate, equivalent to 200 per cent of the quantities identified in Table L-2, must be maintained on the Aerodrome for vehicle replenishment purposes.
  - (15) A reserve supply of complementary agent, equivalent to 100 per cent of the quantity identified in Table L-2, must be maintained on the aerodrome for vehicle replenishment purposes. Sufficient propellant gas must be included to utilize this reserve complementary agent.
  - (16) Category 1 and 2 aerodromes that have replaced up to 100 per cent of the water with complementary agent must hold a reserve supply of complementary agent of 200 per cent.

---

## GACAR PART 139 – CERTIFICATION, AUTHORIZATION AND OPERATION OF AERODROMES

---

- (17) Where a major delay in the replenishment of the supplies is anticipated, the amount of reserve supply in 139.903-(d)-(14), 139.903-(d)-(15) and 139.903-(d)-(16), must be increased as determined by a risk assessment.

(d) Rescue equipment

Rescue equipment commensurate with the level of aircraft operations must be provided on the rescue and fire fighting vehicle(s).

*Note. — Guidance on the rescue equipment to be provided at an aerodrome is given in the Airport Services Manual (Doc 9137), Part 1.*

(e) Response time

- (1) The operational objective of the rescue and firefighting service must be to achieve a response time not exceeding three minutes to any point of each operational runway, as well as to any other part of the movement area, in optimum visibility and surface conditions.
  - (i) Response time is considered to be the time between the initial call to the rescue and firefighting service, and the time when the first responding vehicle(s) is (are) in position to apply foam at a rate of at least 50 per cent of the discharge rate specified in Table L-2.
  - (ii) Optimum visibility and surface conditions are defined as daytime, good visibility, no precipitation with normal response route free of surface contamination e.g., water, ice, or snow.
- (2) To meet the operational objective as nearly as possible in less than optimum conditions of visibility, especially during low visibility operations, suitable guidance, equipment and/or procedures for rescue and firefighting services must be provided.
- (3) Any vehicles, other than the first responding vehicle(s), required to deliver the amounts of extinguishing agents specified in Table L-2 must ensure continuous agent application and must arrive no more than four minutes from the initial call.
- (4) A system of preventive maintenance of rescue and fire fighting vehicles must be employed to ensure effectiveness of the equipment and compliance with the specified response time throughout the life of the vehicle.

---

## **GACAR PART 139 – CERTIFICATION, AUTHORIZATION AND OPERATION OF AERODROMES**

---

### (f) Emergency access roads

- (1) Emergency access roads must be provided on an aerodrome where terrain conditions permit their construction, so as to facilitate achieving minimum response times. Particular attention must be given to the provision of ready access to approach areas up to 1,000 m from the threshold, or at least within the aerodrome boundary. Where a fence is provided, the need for convenient access to outside areas must be taken into account.
- (2) Emergency access roads must be capable of supporting the heaviest vehicles which will use them and be usable in all weather conditions. Roads within 90 m of a runway must be surfaced to prevent surface erosion and the transfer of debris to the runway. Sufficient vertical clearance must be provided from overhead obstructions for the largest vehicles.
- (3) When the surface of the road is indistinguishable from the surrounding area or in areas where snow may obscure the location of the roads, edge markers must be placed at intervals of about 10 m.

### (g) Fire stations

- (1) All rescue and fire fighting vehicles must normally be housed in a fire station. Satellite fire stations must be provided whenever the response time cannot be achieved from a single fire station.
- (2) The fire station must be located so that the access for rescue and fire fighting vehicles into the runway area is direct and clear, requiring a minimum number of turns.

### (h) Communication and alerting systems

- (1) A discrete communication system must be provided linking a fire station with the control tower (if available) any other fire station on the aerodrome and the rescue and fire fighting vehicles.
- (2) An alerting system for rescue and firefighting personnel, capable of being operated from that station, control tower (if available) must be provided at a fire station, any other fire station on the aerodrome and the aerodrome control tower.

### (i) Number of rescue and fire fighting vehicles

- (1) The minimum number of rescue and fire fighting vehicles provided at an aerodrome must be in accordance with the following tabulation.

## GACAR PART 139 – CERTIFICATION, AUTHORIZATION AND OPERATION OF AERODROMES

| Aerodrome category | Rescue and fire fighting vehicles |
|--------------------|-----------------------------------|
| 1                  | 1                                 |
| 2                  | 1                                 |
| 3                  | 1                                 |
| 4                  | 1                                 |
| 5                  | 1                                 |
| 6                  | 2                                 |
| 7                  | 3                                 |
| 8                  | 3                                 |
| 9                  | 3                                 |
| 10                 | 4                                 |

- (2) Unless authorized by the President, rescue and fire fighting vehicles must not be more than fifteen years old.
- (3) Where the international Aerodrome category is (9) or (10), the Aerodrome certificate holder must provide Escape Stair Vehicle.

### (j) Personnel

- (1) All rescue and firefighting personnel must be properly trained to perform their duties in an efficient manner and must participate in live fire drills commensurate with the types of aircraft and type of rescue and firefighting equipment in use at the aerodrome, including pressure-fed fuel fires.
- (2) The rescue and firefighting personnel training program must include training in human performance, including team coordination.
- (3) During flight operations, sufficient trained and competent personnel must be designated to be readily available to ride the rescue and fire fighting vehicles and to operate the equipment at maximum capacity. These personnel must be deployed in a way that ensures that minimum response times can be achieved and that continuous agent application at the appropriate rate can be fully maintained. Consideration must also be given for personnel to use hand lines, ladders and other rescue and firefighting equipment normally associated with aircraft rescue and firefighting operations.
- (4) In determining the minimum number of rescue and firefighting personnel required, a task resource analysis must be completed, and the level of staffing documented in the Aerodrome Manual.

---

## GACAR PART 139 – CERTIFICATION, AUTHORIZATION AND OPERATION OF AERODROMES

---

- (5) All responding rescue and firefighting personnel must be provided with protective clothing and respiratory equipment to enable them to perform their duties in an effective manner.

### § 139.905 Disabled aircraft removal

- (a) A plan for the removal of an aircraft disabled on, or adjacent to, the movement area must be established for an Aerodrome, and a coordinator designated to implement the plan, when necessary.
- (b) The disabled aircraft removal plan must be based on the characteristics of the aircraft that may normally be expected to operate at the aerodrome, and include among other things:
- (1) A list of equipment and personnel on, or in the vicinity of, the aerodrome which would be available for such purpose; and
  - (2) Arrangements for the rapid receipt of aircraft recovery equipment kits available from other aerodromes.

*Note.— Guidance on removal of a disabled aircraft, including recovery equipment, is given in the Airport Services Manual (Doc 9137), Part 5. See also Annex 13 — Aircraft Accident and Incident Investigation concerning protection of evidence, custody and removal of aircraft.*

### § 139.907 Wildlife strike hazard reduction

- (a) The wildlife strike hazard on, or in the vicinity of, an aerodrome must be assessed through:
- (1) The collection of information from aircraft operators, airport personnel, etc. on the presence of wildlife on or around the aerodrome constituting a potential hazard to aircraft operations; and
  - (2) An ongoing evaluation of the wildlife hazard by competent personnel.
- (b) Wildlife strike reports must be collected and forwarded to GACA.
- (c) Action must be taken by aerodrome operator to decrease the risk to aircraft operations by adopting measures to minimize the likelihood of collisions between wildlife and aircraft.

---

## GACAR PART 139 – CERTIFICATION, AUTHORIZATION AND OPERATION OF AERODROMES

---

- (d) The aerodrome operator must take action to eliminate or to prevent the establishment of garbage disposal dumps or any other source which may attracts wildlife to the aerodrome, or its vicinity, unless an appropriate wildlife assessment indicates that they are unlikely to create conditions conducive to a bird hazard problem. Where the elimination of existing sites is not possible, the appropriate authority must ensure that any risk to aircraft posed by these sites is assessed and reduced to as low as reasonably practicable.
- (e) Aerodrome operator must give due consideration to aviation safety concerns related to land developments that may attract wildlife.
- (f) An aerodrome operator must take immediate action to alleviate wildlife hazards whenever they are detected.
- (g) The wildlife hazard assessment required in paragraph (d) of this section must be conducted by a wildlife management specialist who has professional training and/or experience in wildlife hazard management at airports. The wildlife hazard assessment must contain at least the following:
- (1) An analysis of the events or circumstances that prompted the assessment.
  - (2) Identification of the wildlife species observed and their numbers, locations, local movements, and daily and seasonal occurrences.
  - (3) Identification and location of features on and near the airport that attract wildlife.
  - (4) A description of wildlife hazards to air transport operations.
  - (5) Recommended actions for reducing identified wildlife hazards to air transport operations.
- (h) The wildlife hazard assessment required under paragraph (a) of this section must be submitted to the GACA for acceptance and determination of the need for a wildlife hazard management program. In reaching this determination, the Administrator will consider—
- (1) The wildlife hazard assessment;
  - (2) Actions recommended in the wildlife hazard assessment to reduce wildlife hazards;
  - (3) The aeronautical activity at the airport, including the frequency and size of air carrier aircraft; and
  - (4) Any other known factors relating to the wildlife hazard of which the Administrator is aware.

---

## GACAR PART 139 – CERTIFICATION, AUTHORIZATION AND OPERATION OF AERODROMES

---

- (i) When the president determines that a wildlife hazard management program is needed, the certificate holder must formulate and implement the program using the wildlife hazard assessment as a basis. The program must -
- (1) Provide measures to alleviate or eliminate wildlife hazards to air transport operations;
  - (2) Be submitted to, and accepted by, the President prior to implementation; and
  - (3) Become a part of the aerodrome manual.
- (j) A training program conducted by a qualified wildlife hazard management biologist to provide aerodrome personnel with the knowledge and skills needed to successfully carry out the wildlife hazard management plan required by paragraph (g) of this section.

### § 139.909 Apron management service

- (a) When warranted by the volume of traffic and operating conditions, an appropriate apron management service must be provided on an apron by an aerodrome ATS unit, by another aerodrome operating authority, or by a cooperative combination of these, in order to:
- (1) Regulate movement with the objective of preventing collisions between aircraft, and between aircraft and obstacles;
  - (2) Regulate entry of aircraft into, and coordinate exit of aircraft from, the apron with the Aerodrome control tower; and
  - (3) Ensure safe and expeditious movement of vehicles and appropriate regulation of other activities.
- (b) When the aerodrome control tower does not participate in the apron management service, procedures must be established to facilitate the orderly transition of aircraft between the apron management unit and the aerodrome control tower.
- (c) An apron management service must be provided with radiotelephony communications facilities.
- (d) Where low visibility procedures are in effect, persons and vehicles operating on an apron must be restricted to the essential minimum.

---

## GACAR PART 139 – CERTIFICATION, AUTHORIZATION AND OPERATION OF AERODROMES

---

- (e) An emergency vehicle responding to an emergency must be given priority over all other surface movement traffic.
- (f) A vehicle operating on an apron must:
  - (1) Give way to an emergency vehicle; an aircraft taxiing, about to taxi, or being pushed or towed; and
  - (2) Give way to other vehicles in accordance with local regulations.
- (g) An aircraft stand must be visually monitored to ensure that the recommended clearance distances are provided to an aircraft using the stand.
- (h) Apron operations must have at least one wheeled extinguisher having a minimum listed rating of 50kg provided at each gate or stand or at intervals of 61 m along the length of aircraft ramps.

### § 139.911 Ground servicing of aircraft

- (a) Fire extinguishing equipment suitable for at least initial intervention in the event of fuel fire and personnel trained in its use must be readily available during the ground servicing of an aircraft, and there must be a means of quickly summoning the rescue and firefighting service in the event of a fire or major fuel spill.
- (b) When aircraft refueling operations take place while passengers are embarking, on board or disembarking, ground equipment must be positioned so as to allow:
  - (1) The use of a sufficient number of exits for expeditious evacuation; and
  - (2) A ready escape route from each of the exits to be used in an emergency.

### § 139.913 Aerodrome vehicle operations

- (a) A vehicle must be operated:
  - (1) On a maneuvering area only as authorized by the aerodrome control tower; and
  - (2) On an apron only as authorized by the appropriate designated authority of the aerodrome operator.



---

## **GACAR PART 139 – CERTIFICATION, AUTHORIZATION AND OPERATION OF AERODROMES**

---

- (b) The driver of a vehicle on the movement area must comply with all mandatory instructions conveyed by markings and signs unless otherwise authorized by:
  - (1) The aerodrome control tower when on the maneuvering area; or
  - (2) The appropriate designated authority of the aerodrome operator when on the apron.
- (c) The driver of a vehicle on the movement area must comply with all mandatory instructions conveyed by lights.
- (d) The driver of a vehicle on the movement area must be appropriately trained for the tasks to be performed and must comply with the instructions issued by:
  - (1) The aerodrome control tower, when on the maneuvering area; and
  - (2) The aerodrome operator, when on the apron.
- (e) The driver of a radio-equipped vehicle must establish satisfactory two-way radio communication with the aerodrome control tower before entering the maneuvering area and with the aerodrome operator before entering the apron. The driver must maintain a continuous listening watch on the assigned frequency when on the movement area.

### **§ 139.915 Surface movement guidance and control systems**

#### (a) Application

A surface movement guidance and control system (SMGCS) must be provided at an aerodrome.

#### (b) Characteristics

- (1) The design of a SMGCS must take into account:
  - (i) The density of air traffic;
  - (ii) The visibility conditions under which operations are intended;
  - (iii) The need for pilot orientation;
  - (iv) The complexity of the Aerodrome layout; and

---

## **GACAR PART 139 – CERTIFICATION, AUTHORIZATION AND OPERATION OF AERODROMES**

---

- (v) Movements of vehicles.
- (2) The visual aid components of a SMGCS, i.e. markings, lights and signs must be designed to conform to the relevant specifications in § 139.503, § 139.505 and § 139.507, respectively.
  - (3) An SMGCS must be designed to assist in the prevention of inadvertent incursions of aircraft and vehicles onto an active runway.
  - (4) The system must be designed to assist in the prevention of collisions between aircraft, and between aircraft and vehicles or objects, on any part of the movement area.
  - (5) Where an SMGCS is provided by selective switching of stop bars and taxiway center line lights, the following requirements must be met:
    - (i) Taxiway routes which are indicated by illuminated taxiway center line lights must be capable of being terminated by an illuminated stop bar;
    - (ii) The control circuits must be so arranged that when a stop bar located ahead of an aircraft is illuminated, the appropriate section of taxiway center line lights beyond it is suppressed; and
    - (iii) The taxiway center line lights are activated ahead of an aircraft when the stop bar is suppressed.
  - (6) Surface movement radar for the maneuvering area must be provided at an aerodrome intended for use in runway visual range conditions less than a value of 350 m.
  - (7) Surface movement radar for the maneuvering area must be provided at an aerodrome other than that in § 139.915-(b)-(VI) when traffic density and operating conditions are such that regularity of traffic flow cannot be maintained by alternative procedures and facilities.

### **§ 139.917 Siting of equipment and installations on operational areas**

- (a) Unless its function requires it to be there for air navigation or for aircraft safety purposes, no equipment or installation must be:

---

## GACAR PART 139 – CERTIFICATION, AUTHORIZATION AND OPERATION OF AERODROMES

---

- (1) On a runway strip, a runway end safety area, a taxiway strip or within the distances specified in Table F-1, column 11, if it would endanger an aircraft; or;
  - (2) On a clearway if it would endanger an aircraft in the air.
- (b) Any equipment or installation required for air navigation or for aircraft safety purposes which must be located:
- (1) On that portion of a runway strip within:
    - (i) 75 m of the runway centre line where the code number is 3 or 4; or
    - (ii) 45 m of the runway centre line where the code number is 1 or 2; or
  - (2) On a runway end safety area, a taxiway strip or within the distances specified in Table C-1; or
  - (3) On a clearway and which would endanger an aircraft in the air; must be frangible and mounted as low as possible.
- (c) Unless its function requires it to be there for air navigation or for aircraft safety purposes, no equipment or installation must be located within 240 m from the end of the strip and within:
- (1) 60 m of the extended center line where the code number is 3 or 4; or
  - (2) 45 m of the extended center line where the code number is 1 or 2; of a precision approach runway category I, II or III.
- (d) Any equipment or installation required for air navigation or for aircraft safety purposes which must be located on or near a strip of a precision approach runway category I, II or III and which:
- (1) is situated within 240 m from the end of the strip and within:
    - (i) 60 m of the extended runway center line where the code number is 3 or 4; or
    - (ii) 45 m of the extended runway center line where the code number is 1 or 2; or
  - (2) Penetrates the inner approach surface, the inner transitional surface or the balked landing surface; must be frangible and mounted as low as possible.
- (e) Any equipment or installation required for air navigation purposes which is an obstacle of operational significance in accordance with § 139.403-(a)-(4), § 139.403-(b)-(5), § 139.403-(c)-(8) or § 139.403-(d)-(6) must be frangible and mounted as low as possible.

### § 139.919 Fencing

- (a) Application

---

## GACAR PART 139 – CERTIFICATION, AUTHORIZATION AND OPERATION OF AERODROMES

---

- (1) A fence or other suitable barrier must be provided on an aerodrome to prevent the entrance to the movement area of animals large enough to be a hazard to aircraft.
- (2) A fence or other suitable barrier must be provided on an aerodrome to deter the inadvertent premeditated access of an unauthorized person on to a non-public area of the aerodrome.
- (3) Suitable means of protection must be provided to deter the inadvertent or premeditated access of unauthorized persons into ground installations and facilities essential for the safety of civil aviation located off the aerodrome.

### (b) Location

- (1) The fence or barrier must be located so as to separate the movement area and other facilities or zones on the aerodrome vital to the safe operation of aircraft from areas open to public access.
- (2) When greater security is thought necessary, a cleared area must be provided on both sides of the fence or barrier to facilitate the work of patrols and to make trespassing more difficult. Consideration must be given to the provision of a perimeter road inside the aerodrome fencing for the use of both maintenance personnel and security patrols.

### § 139.921 Security lighting

At an aerodrome where it is deemed desirable for security reasons, a fence or other barrier provided for the protection of international civil aviation and its facilities must be illuminated at a minimum essential level. Consideration must be given to locating lights so that the ground area on both sides of the fence or barrier, particularly at access points, is illuminated.

### § 139.923 Autonomous runway incursion warning system (ARIWS)

#### (a) Characteristics

- (1) Where an ARIWS is installed at an aerodrome:
  - (i) It must provide autonomous detection of a potential incursion or of the occupancy of an active runway and a direct warning to a flight crew or vehicle operator;
  - (ii) It must function and be controlled independently of any other visual system on the Aerodrome;

## **GACAR PART 139 – CERTIFICATION, AUTHORIZATION AND OPERATION OF AERODROMES**

---

- (iii) Its visual aid components, i.e. lights, must be designed to conform with the relevant specifications in § 139.505; and
  - (iv) Failure of part or all of it must not interfere with normal Aerodrome operations. To this end, provision must be made to allow the ATC unit to shut down the system partially or entirely.
- (2) Where an ARIWS is installed at an aerodrome, information on its characteristics and status must be provided to the appropriate aeronautical information services for promulgation in the AIP with the description of the aerodrome surface movement guidance and control system and markings as specified in GACAR Part 175.

---

## GACAR PART 139 – CERTIFICATION, AUTHORIZATION AND OPERATION OF AERODROMES

---

### SUBPART M- AERODROME MAINTENANCE

#### § 139.1001 General

- (a) A maintenance program, including preventive maintenance where appropriate, must be established at an Aerodrome to maintain facilities in a condition which does not impair the safety, regularity, or efficiency of air navigation.

*Note 1. — Preventive maintenance is programmed maintenance work done in order to prevent a failure or degradation of facilities.*

*Note 2. — “Facilities” are intended to include such items as pavements, visual aids, fencing, drainage systems, electrical systems, and buildings*

- (b) The design and application of the maintenance must observe human factor principles.

*Note. — Guidance material on Human Factors principles can be found in the Human Factors Training Manual (Doc 9683) and in the Airport Services Manual (Doc 9137), Part 8.*

#### § 139.1003 Pavements

- (a) The surfaces of all movement areas including pavements (runways, taxiways, aprons and adjacent areas) must be inspected and their conditions monitored regularly as part of an Aerodrome preventive and corrective maintenance program with the objective of avoiding and eliminating of any loose stones or other objects that might cause damage to aircraft structures or engines or impair the operation of aircraft systems.

*Note 1. — § See 139.219 (c) for inspections of movement areas.*

*Note 2. — Procedures on carrying out daily inspections of the movement area and control of FOD are given in the PANS-Aerodromes (Doc 9981), the Manual of Surface Movement Guidance and Control Systems (SMGCS) (Doc 9476) and the Advanced Surface Movement Guidance and Control Systems (A-SMGCS) Manual (Doc 9830).*

## GACAR PART 139 – CERTIFICATION, AUTHORIZATION AND OPERATION OF AERODROMES

*Note 3. — Additional guidance on sweeping/cleaning of surfaces is contained in the Airport Services Manual (Doc 9137), Part 9.*

*Note 4. — Guidance on precautions to be taken in regard to the surface of shoulders is given in Attachment A, Section 9, and the Aerodrome Design Manual (Doc 9157), Part 2.*

*Note 5. — Where the pavement is used by large aircraft or aircraft with tire pressures in the upper categories referred to in § 139.213-(f)-(3), particular attention must be given to the integrity of light fittings in the pavement and pavement joints.*

- (b) The surface of a runway must be maintained in a condition such as to prevent formation of harmful irregularities.
- (c) A paved runway must be maintained in a condition so as to provide surface friction characteristics at or above the minimum friction level specified in Table M-1.

| Test equipment                     | Test tire |                   | Test speed<br>(km/h) | Test water<br>depth<br>(mm) | Design<br>objective<br>for new<br>surface | Maintenance<br>planning<br>level | Minimum<br>friction<br>level |
|------------------------------------|-----------|-------------------|----------------------|-----------------------------|---|----------------------------------|------------------------------|
|                                    | Type      | Pressure<br>(kPa) |                      |                             |   |                                  |                              |
| (1)                                | (2)       | (3)               | (4)                  | (5)                         | (6)                                       | (7)                              |                              |
| Mu-meter Trailer                   | A         | 70                | 65                   | 1.0                         | 0.72                                      | 0.52                             | 0.42                         |
|                                    | A         | 70                | 95                   | 1.0                         | 0.66                                      | 0.38                             | 0.26                         |
| Skiddometer Trailer                | B         | 210               | 65                   | 1.0                         | 0.82                                      | 0.60                             | 0.50                         |
|                                    | B         | 210               | 95                   | 1.0                         | 0.74                                      | 0.47                             | 0.34                         |
| Surface Friction<br>Tester Vehicle | B         | 210               | 65                   | 1.0                         | 0.82                                      | 0.60                             | 0.50                         |
|                                    | B         | 210               | 95                   | 1.0                         | 0.74                                      | 0.47                             | 0.34                         |
| Runway Friction<br>Tester Vehicle  | B         | 210               | 65                   | 1.0                         | 0.82                                      | 0.60                             | 0.50                         |
|                                    | B         | 210               | 95                   | 1.0                         | 0.74                                      | 0.54                             | 0.41                         |
| TATRA Friction<br>Tester Vehicle   | B         | 210               | 65                   | 1.0                         | 0.76                                      | 0.57                             | 0.48                         |
|                                    | B         | 210               | 95                   | 1.0                         | 0.67                                      | 0.52                             | 0.42                         |
| RUNAR<br>Trailer                   | B         | 210               | 65                   | 1.0                         | 0.69                                      | 0.52                             | 0.45                         |
|                                    | B         | 210               | 95                   | 1.0                         | 0.63                                      | 0.42                             | 0.32                         |
| GRIPTESTER<br>Trailer              | C         | 140               | 65                   | 1.0                         | 0.74                                      | 0.53                             | 0.43                         |
|                                    | C         | 140               | 95                   | 1.0                         | 0.64                                      | 0.36                             | 0.24                         |

**Table M-1. Runway surface condition levels**

*Note. — Assessment, Measurement and Reporting of Runway Surface Conditions (Cir 355) contains further information on this subject.*

- (d) Runway friction characteristics for maintenance purpose must be periodically measured with a continuous friction measuring device using self-wetting features and documented. The frequency of

---

## GACAR PART 139 – CERTIFICATION, AUTHORIZATION AND OPERATION OF AERODROMES

---

these measurements must be sufficient to determine the trend of the surface friction characteristics of the runway.

*Note 1. — Guidance on evaluating the runway surface friction characteristics is provided in Assessment, Measurement and Reporting of Runway Surface Conditions (Cir 355).*

*Note 2. — The objective of § 139.1003-(c), § 139.1003-(g), and § 139.1003-(h) is to ensure that the surface friction characteristics for the entire runway remain at or above a minimum friction level specified by the President.*

- (e) When runway surface friction measurements are made for maintenance purposes using a self-wetting continuous friction measuring device, the performance of the device must meet the standard set or agreed by the President.
- (f) Personnel measuring runway surface friction required in 139.1003-(e) must be trained to fulfil their duties.
- (g) Corrective maintenance action must be taken to prevent the runway surface friction characteristics for either the entire runway or a portion thereof from failing below a minimum friction level specified by President, as per Table M-1.
- (h) The runway surface must be visually assessed, as necessary, under natural or simulated rain conditions for ponding or poor drainage and where required, corrective maintenance action taken.
- (i) When a taxiway is used by turbine-engine aeroplanes, the surface of the taxiway shoulders must be maintained so as to be free of any loose stones or other objects that could be ingested by the aeroplane engines.

### § 139.1005 Removal of contaminants

- (a) Snow, slush, ice, standing water, mud, dust, sand, oil, rubber deposits and other contaminants must be removed from the surface of runways in use as rapidly and completely as possible to minimize accumulation.

*Note. — The above requirement does not imply that winter operations on compacted snow and ice are prohibited. Information on snow removal and ice control and removal of other contaminants is given in the PANS Aerodromes (Doc 9981).*

- (b) Taxiways must be kept clear of snow, slush, ice, etc., to the extent necessary to enable aircraft to be taxied to and from an operational runway.



---

## GACAR PART 139 – CERTIFICATION, AUTHORIZATION AND OPERATION OF AERODROMES

---

- (c) Aprons must be kept clear of snow, slush, ice, etc., to the extent necessary to enable aircraft to maneuver safely or, where appropriate, to be towed or pushed.
- (d) Whenever the clearance of snow, slush, ice, etc., from the various parts of the movement area cannot be carried out simultaneously, the order of priority after the runway(s) in use must be set in consultation with the affected parties such as rescue and firefighting service and documented in a snow plan.
- (e) Chemicals to remove or to prevent the formation of ice and frost on Aerodrome pavements must be used when conditions indicate their use could be effective. Caution must be exercised in the application of the chemicals so as not to create a more slippery condition.

*Note. — Information on the use of chemicals for Aerodrome pavements is given in the PANS Aerodromes (Doc 9981).*

- (f) Chemicals which may have harmful effects on aircraft or pavements, or chemicals which may have toxic effects on the Aerodrome environment, must not be used.

### § 139.1007 Runway pavement overlays

- (a) The longitudinal slope of the temporary ramp, measured with reference to the existing runway surface or previous overlay course, must be:
  - (1) 0.5 to 1.0 per cent for overlays up to and including 5 cm in thickness; and
  - (2) Not more than 0.5 per cent for overlays more than 5 cm in thickness.
- (b) Overlaying must proceed from one end of the runway toward the other end so that based on runway utilization most aircraft operations will experience a down ramp.
- (c) The entire width of the runway must be overlaid during each work session.
- (d) Before a runway being overlaid is returned to a temporary operational status, a runway center line marking conforming to the specifications in Section § 139.503-(c) must be provided. Additionally, the location of any temporary threshold must be identified by a 3.6 m wide transverse stripe.
- (e) The overlay must be constructed and maintained above the minimum friction level specified in § 139.1003- (3).

---

## GACAR PART 139 – CERTIFICATION, AUTHORIZATION AND OPERATION OF AERODROMES

---

### § 139.1009 Visual aids

- (a) A light must be deemed to be unserviceable when the main beam average intensity is less than 50 per cent of the value specified in the appropriate figure in Appendix H. For light units where the designed main beam average intensity is above the value shown in Appendix H, the 50 per cent value must be related to that design value.
- (b) A system of preventive maintenance of visual aids must be employed to ensure lighting and marking system reliability.
- (c) The system of preventive maintenance employed for a precision approach runway category II or III must include at least the following checks:
  - (1) Visual inspection and in-field measurement of the intensity, beam spread, and orientation of lights included in the approach and runway lighting systems;
  - (2) Control and measurement of the electrical characteristics of each circuitry included in the approach and runway lighting systems; and
  - (3) Control of the correct functioning of light intensity settings used by air traffic control.
- (d) In-field measurement of intensity, beam spread, and orientation of lights included in approach and runway lighting systems for a precision approach runway category II or III must be undertaken by measuring all lights, as far as practicable, to ensure conformance with the applicable specification of Appendix H.
- (e) Measurement of intensity, beam spread, and orientation of lights included in approach and runway lighting systems for a precision approach runway category II or III must be undertaken using a mobile measuring unit of sufficient accuracy to analyze the characteristics of the individual lights.
- (f) The frequency of measurement of lights for a precision approach runway category II or III must be based on traffic density, the local pollution level, the reliability of the installed lighting equipment and the continuous assessment of the results of the in-field measurements but, in any event, must not be less than twice a year for in-pavement lights and not less than once a year for other lights.
- (g) The system of preventive maintenance employed for a precision approach runway category II or III must have as its objective that, during any period of category II or III operations, all approach and runway lights are serviceable, and that in any event at least:
  - (1) 95 per cent of the lights are serviceable in each of the following particular significant elements:

---

## GACAR PART 139 – CERTIFICATION, AUTHORIZATION AND OPERATION OF AERODROMES

---

- (i) Precision approach category II and III lighting system, the inner 450 m;
  - (ii) Runway center line lights;
  - (iii) Runway threshold lights; and
  - (iv) Runway edge lights;
- (2) 90 per cent of the lights are serviceable in the touchdown zone lights;
  - (3) 85 per cent of the lights are serviceable in the approach lighting system beyond 450 m; and
  - (4) 75 per cent of the lights are serviceable in the runway end lights.

In order to provide continuity of guidance, the allowable percentage of unserviceable lights must not be permitted in such a way as to alter the basic pattern of the lighting system. Additionally, an unserviceable light must not be permitted adjacent to another unserviceable light, except in a barrette or a crossbar where two adjacent unserviceable lights may be permitted.

- (h) The system of preventive maintenance employed for a stop bar provided at a runway-holding position used in conjunction with a runway intended for operations in runway visual range conditions less than a value of 350 m must have the following objectives:
  - (1) No more than two lights will remain unserviceable; and
  - (2) Two adjacent lights will not remain unserviceable unless the light spacing is significantly less than that specified.
- (i) The system of preventive maintenance employed for a taxiway intended for use in runway visual range conditions less than a value of 350 m must have as its objective that no two adjacent taxiway center line lights be unserviceable.
- (j) The system of preventive maintenance employed for a precision approach runway category I must have as its objective that, during any period of category I operations, all approach and runway lights are serviceable and that, in any event, at least 85 per cent of the lights are serviceable in each of the following:
  - (1) Precision approach category I lighting system;

---

## GACAR PART 139 – CERTIFICATION, AUTHORIZATION AND OPERATION OF AERODROMES

---

- (2) Runway threshold lights;
- (3) Runway edge lights; and
- (4) Runway end lights.

In order to provide continuity of guidance an unserviceable light must not be permitted adjacent to another unserviceable light unless the light spacing is significantly less than that specified.

(k) The system of preventive maintenance employed for a runway meant for take-off in runway visual range conditions less than a value of 550 m must have as its objective that, during any period of operations, all runway lights are serviceable and that in any event:

- (1) At least 95 per cent of the lights are serviceable in the runway center line lights (where provided) and in the runway edge lights; and
- (2) At least 75 per cent of the lights are serviceable in the runway end lights.

In order to provide continuity of guidance, an unserviceable light must not be permitted adjacent to another unserviceable light.

(l) The system of preventive maintenance employed for a runway meant for take-off in runway visual range conditions of a value of 550 m or greater must have as its objective that, during any period of operations, all runway lights are serviceable and that, in any event, at least 85 per cent of the lights are serviceable in the runway edge lights and runway end lights. In order to provide continuity of guidance, an unserviceable light must not be permitted adjacent to another unserviceable light.

(m) During low visibility procedures the aerodrome director or accountable executive must restrict construction or maintenance activities in the proximity of aerodrome electrical systems.

---

## GACAR PART 139 – CERTIFICATION, AUTHORIZATION AND OPERATION OF AERODROMES

---

### APPENDIX A – CERTIFICATION AND AUTHORIZATION

#### AERODROME COMPATIBILITY STUDY

##### I. Introduction

1. This appendix outlines a methodology and procedure to assess the compatibility between aeroplane operations and aerodrome infrastructure and operations when an aerodrome accommodates an aeroplane that exceeds the certificated characteristics of the aerodrome.
2. A compatibility study must be performed collaboratively between affected stakeholders which includes the aerodrome operator, the aeroplane operator, and ground handling agencies as well as the various air navigation service providers (ANSPs).
  - a. The following steps describe the arrangement, to be appropriately documented, between the aeroplane operator and aerodrome operator for the introduction of an aeroplane type/subtype new to the aerodrome:
    - i. the aeroplane operator submits a request to the aerodrome operator to operate an aeroplane type/subtype new to the aerodrome;
    - ii. the aerodrome operator identifies possible means of accommodating the aeroplane type/subtype including access to movement areas and, if necessary, considers the feasibility and economic viability of upgrading the aerodrome infrastructure; and the aerodrome operator and aircraft operator discuss the aerodrome operator's assessment, and whether operations of the aeroplane type/subtype can be accommodated and, if permitted, under what conditions.
3. The following procedures should be included in the aerodrome compatibility study:
  - a. Identify the aeroplane's physical and operational characteristics;
  - b. Identify the applicable regulatory requirements;
  - c. Establish the adequacy of the aerodrome infrastructure and facilities vis-à-vis the requirements of the new aeroplane;
  - d. Identify the changes required to the aerodrome;
  - e. Document the compatibility study; and
  - f. Perform the required safety assessments identified during the compatibility study.
4. The result of the compatibility study should enable decisions to be made and should provide:
5. The aerodrome operator with the necessary information in order to make a decision on allowing the operation of the specific aeroplane at the given aerodrome;
6. The aerodrome operator with the necessary information in order to make a decision on the changes required to the aerodrome infrastructure and facilities to ensure safe operations at the aerodrome with due consideration to the harmonious future development of the aerodrome; and

---

## GACAR PART 139 – CERTIFICATION, AUTHORIZATION AND OPERATION OF AERODROMES

---

7. The GACA with the information which is necessary for its safety oversight and the continued monitoring of the conditions specified in the aerodrome certification.

### **II. Impact Of Aeroplane Characteristics On The Aerodrome Infrastructure**

1. Introducing new types of aeroplanes into existing aerodromes may have an impact on the aerodrome facilities and services, in particular, when the aeroplane characteristics exceed the parameters that were used for planning the aerodrome.
2. The parameters used in aerodrome planning are defined in this part, which specifies the use of the aerodrome reference code determined in accordance with the characteristics of the aeroplane for which an aerodrome facility is intended. The aerodrome reference code provides a starting point for the compatibility study and may not be the sole means used to conduct the analysis and to substantiate the aerodrome operator's decisions and the GACA's safety oversight actions.
3. The aeroplane's physical characteristics may influence the aerodrome dimensions, facilities and services in the movement area.
4. In order to adequately assess aerodrome compatibility, aeroplane operational characteristics must be included in the evaluation process. The operational characteristics can include the infrastructure requirements of the aeroplane as well as ground servicing requirements.
5. In order to adequately assess the aeroplane's compatibility, aerodrome physical characteristics must be included in the evaluation process.

---

## GACAR PART 139 – CERTIFICATION, AUTHORIZATION AND OPERATION OF AERODROMES

---

### APPENDIX B – CERTIFICATION OF AERODROMES

#### APPENDIX- B-1 AERODROME MANUAL CONTENT

##### I. Introduction

1. Purpose of the Aerodrome manual.
2. Legal position regarding Aerodrome certification as contained in the applicable regulation.
3. Distribution of the Aerodrome manual.
4. Procedures for distributing and amending the Aerodrome manual and the circumstances in which amendments may be needed.
5. Checklist of pages.
6. Preface by licence holder.
7. Table of contents.
8. Glossary of terms.
9. Abbreviations, if any.

##### II. Technical administration

1. Name and address of the aerodrome.
2. Name and address of the aerodrome operator.
3. The name of the accountable executive.
4. Names of all post holders, accepted by GACA, indicating their duties and responsibilities.
5. Organisation structure.

##### III. Description of the Aerodrome (Aerodrome characteristics)

1. Details of the following:
  - a. Latitude and longitude of the Aerodrome reference point in World Geodetic System — 1984 (WGS-84) format.
  - b. Elevations of:
    - i. Aerodrome
    - ii. Apron
2. Plans showing the position of the aerodrome reference point, layout of the runways, taxiways, and aprons; the Aerodrome markings and lighting (including the precision approach path indicator (PAPI) and obstruction lighting); and the siting of navigation aids within the runway

---

## GACAR PART 139 – CERTIFICATION, AUTHORIZATION AND OPERATION OF AERODROMES

---

- strips. It will not be necessary for these plans or the information called for in subparagraphs c) to f) below to accompany all copies of the Aerodrome manual, but they are to be appended to the licence holder's master copy and to the copy kept with the President. Operating staff are to be provided with scaled-down copies or extracts of plans relevant to their duties.
3. Description, height, and location of obstacles that infringe upon the standard protection surfaces, whether they are lighted and if they are noted in the aeronautical publications.
  4. Procedures for ensuring that the plans are up to date and accurate.
  5. Data for, and the method used to calculate, declared distances and elevations at the beginning and end of each declared distance.
  6. Details of the surfaces, dimensions and classification or bearing strengths of runways, taxiways and aprons.

#### **IV. List of authorized deviations, if any.**

#### **V. Operational procedures for:**

##### **V.1 Promulgation of aeronautical information**

The system of aeronautical information service available and the system that the certificate holder uses to promulgate AIP requirements.

##### **V.2 Control of access**

Control of access to the Aerodrome and its operational areas, including the location of notice boards, and the control of vehicles in the operational areas.

##### **V.3 Emergency planning**

1. The Aerodrome operator's arrangements in response to an emergency. These arrangements must take account of the complexity and size of the Aeroplane operation.
2. Description of actions to be taken by the Aerodrome operator as part of plans for dealing with different emergencies occurring at the Aerodrome or in its vicinity.
3. Contact list of organizations, agencies and persons of authority.
4. Procedures for the appointment of an on-scene commander for the overall emergency operation and description of responsibilities for each type of emergency.
5. Reporting mechanism in the event of emergency.
6. Details of tests of Aerodrome facilities and equipment to be used in emergencies, including the frequency of those tests.
7. Details of the exercises to test emergency plans, including the frequency of those exercises.



---

## GACAR PART 139 – CERTIFICATION, AUTHORIZATION AND OPERATION OF AERODROMES

---

8. Arrangements for personnel training and preparation for dealing with emergencies.

### V.4 Rescue and fire fighting (RFF) services

1. Policy statement on the RFF categories to be provided.
2. Where the senior Aerodrome fire officer or designated fire watch officers have specific safety accountabilities, these must be included in the relevant chapter of the Aerodrome manual.
3. Policy and procedures indicating how depletion of the RFF service is to be managed. This must include the extent to which operations are to be restricted, how pilots are to be notified and the maximum duration of any depletion.
4. At Aerodromes where a higher category of RFF is available by prior arrangement, the Aerodrome manual must clearly state the actions necessary to upgrade the facility. Where necessary, this must include actions to be taken by other departments.
5. The Aerodrome operator's objectives for each RFF category provided must be defined, including a brief description of:
  - a. Amounts of extinguishing agents provided;
  - b. Discharge rates;
  - c. Number of foam-producing appliances;
  - d. Manning levels;
  - e. Levels of supervision.
6. Procedures for:
  - a. Monitoring the aeroplane movement areas for the purpose of alerting RFF personnel;
  - b. Indicating how the adequacy of the response time capability of the RFF services throughout their functions and locations is monitored and maintained;
  - c. Indicating how RFF personnel engaged in extraneous duties are managed to ensure that response capability is not affected.
7. Where the Aerodrome provides specialist equipment such as rescue craft, emergency tenders, hose layers, and appliances with aerial capability, details must be included in the aerodrome manual. Procedures to be followed if these facilities are temporarily unavailable must also be included.
8. Where the aerodrome is reliant upon other organizations to provide equipment, which is essential for ensuring the safe operation of the aerodrome (perhaps water rescue), policies or letters of agreement must be included in the aerodrome manual. Where necessary, contingency plans in the event of non-availability must be described.
9. A statement describing the process by which aerodrome operators ensure the initial and continued competence of their RFF personnel, including the following:
  - a. Realistic fuel fire training;
  - b. Breathing apparatus training in heat and smoke;
  - c. First aid;

---

## GACAR PART 139 – CERTIFICATION, AUTHORIZATION AND OPERATION OF AERODROMES

---

- d. Low visibility procedures (LVP);
  - e. Any legal requirements;
  - f. Health and safety policy regarding training of personnel in the use of respiratory protection equipment and personal protection equipment.
10. Procedures indicating how accidents in the immediate vicinity of the aerodrome are to be accessed. Where difficult environs exist, the aerodrome manual must indicate how these are to be accessed.
  11. Where local authorities or the Aerodrome operator expects the RFF facility to respond to domestic fires or special services, procedures for managing their impact upon normal Aeroplane RFF responses must be included.
  12. Where the aerodrome operator expects the RFF facility to respond to aeroplane accidents landside, the policy must be clearly described, including procedures to manage the effects on continued aeroplane operations.
  13. The availability of additional water supplies must be described.
  14. Aerodrome operator's arrangements for ensuring the adequacy of responses in abnormal conditions, i.e., LVP.

### V.5 Inspections of the movement area

1. Routine aerodrome inspections, including lighting inspections, and reporting, including the nature and frequency of these inspections.
2. Inspecting the apron, runways and taxiways following a report of debris on the movement area, an abandoned take-off due to engine, tire or wheel failure, or any incident likely to result in debris being left in a hazardous position.
3. Sweeping of runways, taxiways, and aprons.
4. Measurement and promulgation of water, slush and other contaminants including depths on runways and taxiways.
5. Assessment and promulgation of runway surface conditions:
  - a. Details of inspection intervals and times;
  - b. Completion and effective use of an inspection checklist;
  - c. Arrangements and methods for carrying out inspections on FOD, lighting, pavement surface, grassing;
  - d. Arrangements for reporting the results of inspections and for follow-up;
  - e. Arrangements and means of communication with air traffic control during an inspection;
  - f. Arrangements for keeping an inspection logbook and the location of the logbook.

### V.6 Maintenance of the movement area

---

## GACAR PART 139 – CERTIFICATION, AUTHORIZATION AND OPERATION OF AERODROMES

---

1. Promulgation of information on the aerodrome operational state, temporary withdrawals of facilities, runway closures, etc.:
  - a. Arrangements for maintaining the paved areas, including the runway friction assessments;
  - b. Arrangements for maintaining the unpaved runways and taxiways;
  - c. Arrangements for maintaining the runway and taxiway strips;
  - d. Arrangements for maintaining Aerodrome drainage;
  - e. Arrangements for maintaining the visual aids, including the measurement of intensity, beam spread and orientation of lights;
  - f. Arrangements for maintaining the obstacle lighting;
  - g. Arrangements for reporting and action taken in the event of failure or unsafe occurrence.

### V.7 Snow and ice control, sand, and other hazardous meteorological conditions

Description of the procedures.

### V.8 Visual aids

1. Responsibilities with respect to the aerodrome ground lighting system.
2. A full description of all visual aids available on each approach, runway, taxiway, and apron, including signs, markings and signals.
3. Procedures for operational use and brilliancy settings of the lighting system.
4. Standby and emergency power arrangements, including operating procedures both in LVP and during main power failure situations.
5. Procedures for routine inspection and photometric testing of approach lights, runway lights, and PAPIs.
6. The location of and responsibility for obstacle lighting on and off the aerodrome.
7. Procedures for recording inspection and maintenance of visual aids and actions to be taken in the event of failures.
8. The control of work, including trenching and agricultural activity, which may affect the safety of the aeroplane.

### V.9 Apron management

1. Arrangements between air traffic control, the aerodrome operator, and the apron management unit.
2. Arrangements for allocating aeroplane stands.
3. Arrangements for initiating engine start and ensuring clearance of aeroplane pushback.

## **GACAR PART 139 – CERTIFICATION, AUTHORIZATION AND OPERATION OF AERODROMES**

---

### **V.10 Apron safety management**

1. Means and procedures for jet blast protection.
2. Arrangements of safety precautions during aeroplane refuelling operations.
3. Arrangements for apron sweeping and cleaning.
4. Arrangements for reporting incidents and accidents on an apron.
5. Arrangements for assessing the safety compliance of all personnel working on the apron.
6. Arrangements for the use of advanced visual docking systems, if provided.

### **V.11 Vehicles on the movement area**

1. Details of the applicable traffic rules (including speed limits and the means of enforcing the rules).
2. Method and criteria for allowing drivers to operate vehicles on the movement area.
3. Arrangements and means of communicating with air traffic control.
4. Details of the equipment needed in vehicles that operate on the movement area.

### **V.12 Wildlife hazard management**

1. Arrangements and method for dispersal of bird and other wildlife.
2. Measure to discourage birds and other wildlife.
3. Arrangements for assessing wildlife hazards.
4. Arrangements for implementing wildlife control programmes.

### **V.13 Obstacles**

1. Arrangements for monitoring the height of buildings or structures within the boundaries of the obstacle limitation surfaces (OLS).
2. Arrangements for controlling new developments in the vicinity of aerodromes.
3. The reporting procedure and actions to be taken in the event of the appearance of unauthorized obstacles.
4. Arrangements for removal of an obstacle.

### **V.14 The removal of a disabled aeroplane**

---

## GACAR PART 139 – CERTIFICATION, AUTHORIZATION AND OPERATION OF AERODROMES

---

1. Details of the capability for removal of a disabled aeroplane.
2. Arrangements for removing a disabled aeroplane, including the reporting and notifying procedures and liaison with ATC.

### V.15 Dangerous goods

Arrangements for special areas on the aerodrome to be set up for the storage of dangerous goods.

### V.16 Low visibility operations

1. Obtaining and disseminating meteorological information, including runway visual range (RVR) and surface visibility.
2. Protection of runways during LVP if such operations are permitted.
3. The arrangement and rules before, during and after low visibility operations, including applicable rules for vehicles and personnel operating in the movement area.

### V.17 Protection of sites for radar, navigation aids and meteorological equipment

Description of the areas to be protected and procedures for their protection.

## VI. Safety management system (SMS)

1. Safety policy.
2. Operator's structure and responsibility. This must include:
  - a. The name, status, and responsibilities of the accountable executive;
  - b. The name, status, and responsibilities of the safety manager;
  - c. The name, status, and responsibilities of other senior operating staff;
  - d. The name, status, and responsibilities of the official in charge of day-to-day operations;
  - e. Instructions as to the order and circumstances in which the above-named staff may act as the official in charge or accountable executive;
  - f. An organizational chart supporting the commitment to the safe operation of the aerodrome as well as one simply showing the hierarchy of responsibility for safety management.
3. Training.
4. Complying with regulatory requirements relating to accidents, incidents, and mandatory occurrence reporting.
5. Hazard analysis and risk assessment.
6. The management of change.
7. Safety criteria and indicators.
8. Safety audits.

---

## GACAR PART 139 – CERTIFICATION, AUTHORIZATION AND OPERATION OF AERODROMES

---

9. Documentation.
10. Safety-related committees.
11. Safety promotion.
12. Responsibility for monitoring the contractors and third parties operating on the Aerodrome.

### VII. Term of Reference related to the Runway safety team

1. The RST must agree to a set of procedural rules governing the actions of their representatives. Once formally documented and accepted, these rules will be referred to as the “Terms of Reference” (ToR) of the RST.
2. The ToRs for the RST include:
  - a. Objectives, scope of oversight, and expected frequency of RST meetings
  - b. Membership selection processes
  - c. Roles and responsibilities of individual RST members
  - d. Processes and formal agreements governing sharing of safety data, safety reports, and safety information as well as the protection of the sources of information shared within the RST (protection from inappropriate use and protection against disclosure)
  - e. Consultation, decision-making and conflict resolution processes
  - f. Regularly review the airfield to ensure its adequacy and compliance with ICAO SARPs
  - g. Ensure that the recommendations contained in the ICAO Doc 9870 - Manual on the Prevention of Runway Incursions are implemented
  - h. Documentation and reporting requirements
  - i. Monitor runway incidents by type, severity and frequency of occurrence
  - j. Identify risk factors and local issues, particular locations where risk exist (e.g., hot spots), and problems in daily operations and suggest improvements
  - k. Solicit assistance by safety experts from within the industry
  - l. Contribute to active development of solutions to these issues
  - m. Ensure that the best possible solution is implemented
  - n. Learn lessons from other incidents and consider the outcome of other investigation reports
  - o. Disseminate information on developed solutions to stakeholders
  - p. Initiate a comprehensive safety-awareness campaign to ensure that all stakeholders’ staffs are aware of safety issues, such as producing and distributing local hot spot maps or other guidance material

**GACAR PART 139 – CERTIFICATION, AUTHORIZATION AND OPERATION OF  
AERODROMES**

---

**APPENDIX -B-2. PARTICULARS TO BE INCLUDED IN STANDARD OPERATING  
PROCEDURES**

Name of the Standard Operating Procedure:

---

1. Purpose
2. Document Control
  - (a) Approving authority
  - (b) Responsible department and official for SOP implementation.
  - (c) Relevant stake holders
  - (d) Revision history, if any.
3. Regulatory and other references
  - (a) Applicable regulation(s)
  - (b) External documents, if any.
  - (c) Reference of associated SOP(s)
4. Implementation
  - (a) Description
  - (b) Flow chart (Mandatory for international airports and optional for domestic airports)
  - (c) Responsible
5. Support
  - (a) Internal department interface
  - (b) External interfaces, if any.
  - (c) System, Material and equipment
  - (d) Related internal documents (Check lists/Forms)
6. Glossary and abbreviation

**GACAR PART 139 – CERTIFICATION, AUTHORIZATION AND OPERATION OF  
AERODROMES**

---

**APPENDIX C – AUTHORIZATION OF AERODROMES**

Reserved.



**GACAR PART 139 – CERTIFICATION, AUTHORIZATION AND OPERATION OF  
AERODROMES**

---

**APPENDIX D – DESIGN AND ESTABLISHMENT OF AERODROME**

Reserved.

---

## GACAR PART 139 – CERTIFICATION, AUTHORIZATION AND OPERATION OF AERODROMES

---

### APPENDIX E – AERODROME DATA

#### APPENDIX E-1. Standard method for reporting the bearing strength of the pavement in terms of the Pavement Classification (PCN). (applicable until 27 November 2024).

As per the GACAR 139.213, the bearing strength of the pavement intended for aircraft of mass greater than 5,700 kg must be made available using the Aircraft Classification Number — Pavement Classification Number (ACN-PCN) method by reporting all of the following information:

- (a) The pavement classification number (PCN);
- (b) Pavement type for ACN-PCN determination;
- (c) Subgrade strength category;
- (d) Maximum allowable tire pressure category or maximum allowable tire pressure value; and
- (e) Evaluation method.

Therefore, the Aerodrome operator must submit the PCN evaluation report by incorporating the following aspects:

#### 1. Pavement Design.

The PCN technical evaluation is an inversion of design method, therefore, the copy of the pavement design carried out prior to construction must be submitted with PCN evaluation report. The following details from the pavement design at least but not limited to; must be indicated in the PCN evaluation report:

- (a) Brief description of the design, with cross sections and layout plan showing existing and proposed designed infrastructure for construction;
- (b) Aircrafts mix fleet with annual coverage, gross weight of the aircrafts and designed life considered in the pavement design;
- (c) Subgrade strength i.e., California Bearing Ratio (CBR) value considered for flexible pavement design, supported with Soil/Geo-technical investigation report;

---

## GACAR PART 139 – CERTIFICATION, AUTHORIZATION AND OPERATION OF AERODROMES

---

- (d) Modulus of subgrade reaction K-value in terms of the  $\text{MN/m}^3$  considered for Rigid pavement design supported with Soil/Geo-technical investigation report.
- (e) Flexural strength of the Portland Cement Concrete (PCC) / Pavement Quality Concrete (PQC) considered for design of the rigid pavement;
- (f) Aircrafts classification number (ACNs) of the various aircrafts considered in the Aircrafts Fleet Mix on their Gross Weight.
- (g) Designed Pavement Classification Numbers (PCNs) report, if any.

### 2. Determination of the Pavement Classification Number (PCN).

The PCNs of the airfield infrastructure (Runway, Taxiway, Apron and Stopway) after construction or rehabilitation or resurfacing must be determined based upon the construction details and technical evaluation carried out. The PCN evaluation report must be prepared covering the following components of the ACN-PCN concept:

#### (a) Reported PCN.

The PCN to be reported must be determined on the basis of the aircraft loads (masses) which the evaluation establishes as maximum allowable for the pavement. By using the evaluation load for one of the heaviest types of the aircraft using the pavement and information shown in Appendix 5 of the ICAO Doc 9157 Part 3 – Pavements, and interpolating as necessary, the PCN can be found. This can be done for a selected representative Aircraft or for several aircraft for which evaluation of allowable load has been made. All such determinations should yield the same PCN value, or very nearly so. If there are large differences, it would be well to recheck. If differences are small, an average or lower range value should be selected for reporting. If needed information is not provided in Appendix 5 of the ICAO Doc 9157 Part 3 – Pavements, they can be obtained from the aircraft Manufacturer manual. The screen shots of the aircraft manual graphs/data must be attached/provided with the report. If the FAA software COMFAA and/or FAARFIELD are used, the screenshot of the input and output data with notes/saved files must be provided in the PCN evaluation report. For determining the allowable loads of the rigid pavement, the flexural strength obtained from the construction data or evaluation must be the considered, calculating allowable loads. If dynamic load testing method / non-destructive / Heavy Weight Deflectometer (HWD) or any other device is used to predict the behaviour of the pavement, then the evaluation report must clearly indicate how the allowable load is determined and PCN is assigned/calculated. The screen shot of the software's input and output must be provided in the evaluation report.

#### (b) Pavement type.

---

## GACAR PART 139 – CERTIFICATION, AUTHORIZATION AND OPERATION OF AERODROMES

---

The pavement will be considered rigid (code - R) if its primary load distribution capability is provided by a plain, reinforced or Portland cement concrete (PCC) layer. The pavement constructed with stabilized material such as aggregates or earth should be reported as flexible pavement (code - F).

**(c) Subgrade strength.**

The subgrade strength of the flexible pavement in terms of the CBR and K-value in terms of the MN/m<sup>3</sup> of the rigid pavement must be calculated on the basis of construction records or as per the test results or by interpolating data. The evaluation report must be clearly indicated, how the subgrade strength is determined. Depending upon the subgrade strength values, the subgrade strength code A or B or C or D shall be assigned.

**(d) Tire pressure.**

The tire pressure category code W or X or Y or Z must be assigned depending upon the tire pressures values considered during the evaluation.

**(e) Method Used to Determine PCN.**

The PCN system recognizes two pavement evaluation methods. If the evaluation is made on the results of a technical study, the evaluation method should be coded as T. If the evaluation is based on “Using aircraft” experience, the evaluation method should be coded as U. Technical evaluation implies that the technical study and computation involved in the determination of the PCN. Using aircraft evaluation means the PCN, is determined by selecting the highest ACN among the aircraft currently using the facility and not causing pavement distress.

**(f) Example PCN Reporting**

**Rigid pavement**

An example of a PCN code is 80/R/B/W/T—with 80 expressing the PCN numerical value, R for rigid pavement, B for medium strength subgrade, W for no tire pressure limit, and T for a PCN value obtained by a technical evaluation.

**Flexible pavement**

An example of a PCN code is 80/F/B/W/T—with 80 expressing the PCN numerical value, F for flexible pavement, B for medium strength subgrade, W for no tire pressure limit, and T for a PCN value obtained by a technical evaluation.

**3. Reference documents:**

---

## **GACAR PART 139 – CERTIFICATION, AUTHORIZATION AND OPERATION OF AERODROMES**

---

Aerodrome operator or their Consultants are advised to use the following documents for determination of the PCN. If any other document is referred, that must be clearly indicated in the PCN evaluation report.

- (a) GACAR 139 – version 7.0;
- (b) ICAO Annex 14 Volume I - 9<sup>th</sup> edition, July 2022;
- (c) ICAO Doc 9157 Part 3 – Pavements;
- (d) Aircraft Manual published by the Aircraft Manufacturers;
- (e) FAA Advisory AC No: 150/5335-5C for Standardized Method of Reporting Airport Pavement Strength – PCN;
- (f) FAA Advisory AC No: 150/5320-6E for Airport Pavement Design and Evaluation;
- (g) FAA Advisory AC No: 150/5370-11B of Use of Non-destructive Testing in the Evaluation of Airport Pavements.
- (h) FAA Software's COMFAA and FAARFIELD.

**GACAR PART 139 – CERTIFICATION, AUTHORIZATION AND OPERATION OF  
AERODROMES**

---

**APPENDIX E-2.**

Reserved.

---

## **GACAR PART 139 – CERTIFICATION, AUTHORIZATION AND OPERATION OF AERODROMES**

---

### **APPENDIX E-3. Runway condition report for reporting runway surface condition**

1. On a global level, movement areas are exposed to a multitude of climatic conditions and consequently a significant difference in the condition to be reported. The runway condition report (RCR) describes a basic methodology applicable for all climatic variations.
2. The concept of the RCR is premised on:
  - a) An agreed set of criteria used in a consistent manner for runway surface condition assessment, aeroplane (performance) certification and operational performance calculation;
  - b) A unique runway condition code (RWYCC) linking the agreed set of criteria with the aircraft landing and take-off performance table, and related to the braking action experienced and eventually reported by flight crews;
  - c) Reporting of contaminant type and depth that is relevant to take-off performance;
  - d) A standardized common terminology and phraseology for the description of runway surface conditions that can be used by Aerodrome operator inspection personnel, air traffic controllers, aircraft operators and flight crew; and
  - e) Globally harmonized procedures for the establishment of the RWYCC with a built-in flexibility to allow for local variations to match the specific weather, infrastructure and other particular conditions.
3. These harmonized procedures are reflected in a runway condition assessment matrix (RCAM) which correlates the RWYCC, the agreed set of criteria and the aircraft braking action which the flight crew must expect for each value of the RWYCC.
4. Procedures which relate to the use of the RCAM are provided in the PANS-Aerodromes (Doc 9981).
5. It is important to follow standard procedures when providing assessed information on the runway surface conditions to ensure that safety is not compromised when Aeroplanes use wet or contaminated runways. Personnel must be trained in the relevant fields of competence and their competence verified in a manner required by the President to ensure confidence in their assessments.
6. The aerodrome operator training syllabus must include initial and periodic recurrent training in the following areas:
  - (a) Aerodrome familiarization, including Aerodrome markings, signs and lighting;
  - (b) Aerodrome procedures as described in the Aerodrome manual;
  - (c) Aerodrome emergency plan;
  - (d) Notice to Airmen (NOTAM) initiation procedures;
  - (e) Completion of/initiation procedures for RCR;
  - (f) Aerodrome driving rules;
  - (g) Air traffic control procedures on the movement area;
  - (h) Radiotelephone operating procedures;
  - (i) Phraseology used in Aerodrome control, including the ICAO spelling alphabet;

## GACAR PART 139 – CERTIFICATION, AUTHORIZATION AND OPERATION OF AERODROMES

- (j) Aerodrome inspection procedures and techniques;
  - (k) Type of runway contaminants and reporting;
  - (l) Assessment and reporting of runway surface friction characteristics;
  - (m) Use of runway friction measurement device;
  - (n) Calibration and maintenance of runway friction measurement device;
  - (o) Awareness of uncertainties related to (l) and (m); and
  - (p) Low visibility procedures.
7. List of Tables used in Runway Condition Report
- (a) Table for percentage of coverage for contaminants

| <i>Assessed per cent</i> | <i>Reported per cent</i> |
|--------------------------|--------------------------|
| 10 – 25                  | 25                       |
| 26 – 50                  | 50                       |
| 51 – 75                  | 75                       |
| 76 – 100                 | 100                      |

**Table AE-1. Percentage of coverage for contaminants**

- (b) Table for depth assessment of contaminants



## GACAR PART 139 – CERTIFICATION, AUTHORIZATION AND OPERATION OF AERODROMES

| <i>Contaminant</i> | <i>Valid values to be reported</i> | <i>Significant change</i>      |
|--------------------|------------------------------------|--------------------------------|
| STANDING WATER     | 04, then assessed value            | 3 mm up to and including 15 mm |
| SLUSH              | 03, then assessed value            | 3 mm up to and including 15 mm |
| WET SNOW           | 03, then assessed value            | 5 mm                           |
| DRY SNOW           | 03, then assessed value            | 20 mm                          |

*Note 1.— For STANDING WATER, 04 (4 mm) is the minimum depth value at and above which the depth is reported. (From 3 mm and below, the runway third is considered WET).*

*Note 2.— For SLUSH, WET SNOW and DRY SNOW, 03 (3 mm) is the minimum depth value at and above which the depth is reported.*

*Note 3.— Above 4 mm for STANDING WATER and 3 mm for SLUSH, WET SNOW and DRY SNOW an assessed value is reported and a significant change relates to observed change from this assessed value.*

**Table AE-2. Depth assessment for contaminants**

(c) Table for assessing a runway condition code (RWYCC)

## GACAR PART 139 – CERTIFICATION, AUTHORIZATION AND OPERATION OF AERODROMES

| <i>Runway condition description</i>  | <i>Runway condition code (RWYCC)</i> |
|--|--------------------------------------|
| <b>DRY</b>   | <b>6</b>                             |
| <b>FROST</b><br>WET (the runway surface is covered by any visible dampness or water up to and including 3 mm deep)<br>SLUSH (up to and including 3 mm depth)<br>DRY SNOW (up to and including 3 mm depth)<br>WET SNOW (up to and including 3 mm depth)                         | <b>5</b>                             |
| <b>COMPACTED SNOW</b><br>(Outside air temperature minus 15 degrees Celsius and below)  | <b>4</b>                             |
| WET ("Slippery wet" runway)<br>DRY SNOW (more than 3 mm depth)<br>WET SNOW (more than 3 mm depth)<br>DRY SNOW ON TOP OF COMPACTED SNOW (any depth)<br>WET SNOW ON TOP OF COMPACTED SNOW (any depth)<br>COMPACTED SNOW (outside air temperature above minus 15 degrees Celsius) | <b>3</b>                             |
| STANDING WATER (more than 3 mm depth)<br>SLUSH (more than 3 mm depth)  | <b>2</b>                             |
| <b>ICE</b>   | <b>1</b>                             |
| WET ICE<br>WATER ON TOP OF COMPACTED SNOW<br>DRY SNOW OR WET SNOW ON TOP OF ICE  | <b>0</b>                             |

**Table AE-3. Assigning a runway condition code (RWYCC)**

(d) Table for correlation of runway condition code and pilot reports of runway braking action

## GACAR PART 139 – CERTIFICATION, AUTHORIZATION AND OPERATION OF AERODROMES

| <i>Pilot report of runway braking action</i> | <i>Description</i>   | <i>Runway condition code (RWYCC)</i> |
|--|--|--------------------------------------|
| N/A  |  | 6                                    |
| GOOD   | Braking deceleration is normal for the wheel braking effort applied AND directional control is normal                              | 5                                    |
| GOOD TO MEDIUM                               | Braking deceleration OR directional control is between good and medium   | 4                                    |
| MEDIUM                                       | Braking deceleration is noticeably reduced for the wheel braking effort applied OR directional control is noticeably reduced       | 3                                    |
| MEDIUM TO POOR                               | Braking deceleration OR directional control is between medium and poor   | 2                                    |
| POOR   | Braking deceleration is significantly reduced for the wheel braking effort applied OR directional control is significantly reduced | 1                                    |
| LESS THAN POOR                               | Braking deceleration is minimal to non-existent for the wheel braking effort applied OR directional control is uncertain           | 0                                    |

**Table AE-4. Correlation of runway condition code and pilot reports of runway braking action**

## GACAR PART 139 – CERTIFICATION, AUTHORIZATION AND OPERATION OF AERODROMES

(e) Table for Runway condition assessment matrix (RCAM)

| Runway condition assessment matrix (RCAM) |   |   |                                       |
|---|---|---|---------------------------------------|
| Assessment criteria                       |   | Downgrade assessment criteria   |                                       |
| Runway condition code                     | Runway surface description  | Aeroplane deceleration or directional control observation   | Pilot report of runway braking action |
| 6   | <ul style="list-style-type: none"> <li>• DRY</li> </ul>   | ---   | —                                     |
| 5   | <ul style="list-style-type: none"> <li>• FROST</li> <li>• WET (The runway surface is covered by any visible dampness or water up to and including 3 mm depth)</li> </ul> <p>Up to and including 3 mm depth:</p> <ul style="list-style-type: none"> <li>• SLUSH</li> <li>• DRY SNOW</li> <li>• WET SNOW</li> </ul>   | Braking deceleration is normal for the wheel braking effort applied AND directional control is normal.                              | GOOD                                  |
| 4   | <p>–15°C and Lower outside air temperature:</p> <ul style="list-style-type: none"> <li>• COMPACTED SNOW</li> </ul>  | Braking deceleration OR directional control is between Good and Medium.   | GOOD TO MEDIUM                        |
| 3   | <ul style="list-style-type: none"> <li>• WET ("slippery wet" runway)</li> <li>• DRY SNOW or WET SNOW (any depth) ON TOP OF COMPACTED SNOW</li> </ul> <p>More than 3 mm depth:</p> <ul style="list-style-type: none"> <li>• DRY SNOW</li> <li>• WET SNOW</li> </ul> <p>Higher than –15°C outside air temperature<sup>1</sup>:</p> <ul style="list-style-type: none"> <li>• COMPACTED SNOW</li> </ul> | Braking deceleration is noticeably reduced for the wheel braking effort applied OR directional control is noticeably reduced.       | MEDIUM                                |
| 2   | <p>More than 3 mm depth of water or slush:</p> <ul style="list-style-type: none"> <li>• STANDING WATER</li> <li>• SLUSH</li> </ul>  | Braking deceleration OR directional control is between Medium and Poor.   | MEDIUM TO POOR                        |
| 1   | <ul style="list-style-type: none"> <li>• ICE<sup>2</sup></li> </ul>   | Braking deceleration is significantly reduced for the wheel braking effort applied OR directional control is significantly reduced. | POOR                                  |
| 0   | <ul style="list-style-type: none"> <li>• WET ICE<sup>2</sup></li> <li>• WATER ON TOP OF COMPACTED SNOW<sup>2</sup></li> <li>• DRY SNOW or WET SNOW ON TOP OF ICE<sup>2</sup></li> </ul>   | Braking deceleration is minimal to non-existent for the wheel braking effort applied OR directional control is uncertain.           | LESS THAN POOR                        |

<sup>1</sup>Runway surface temperature should preferably be used where available.

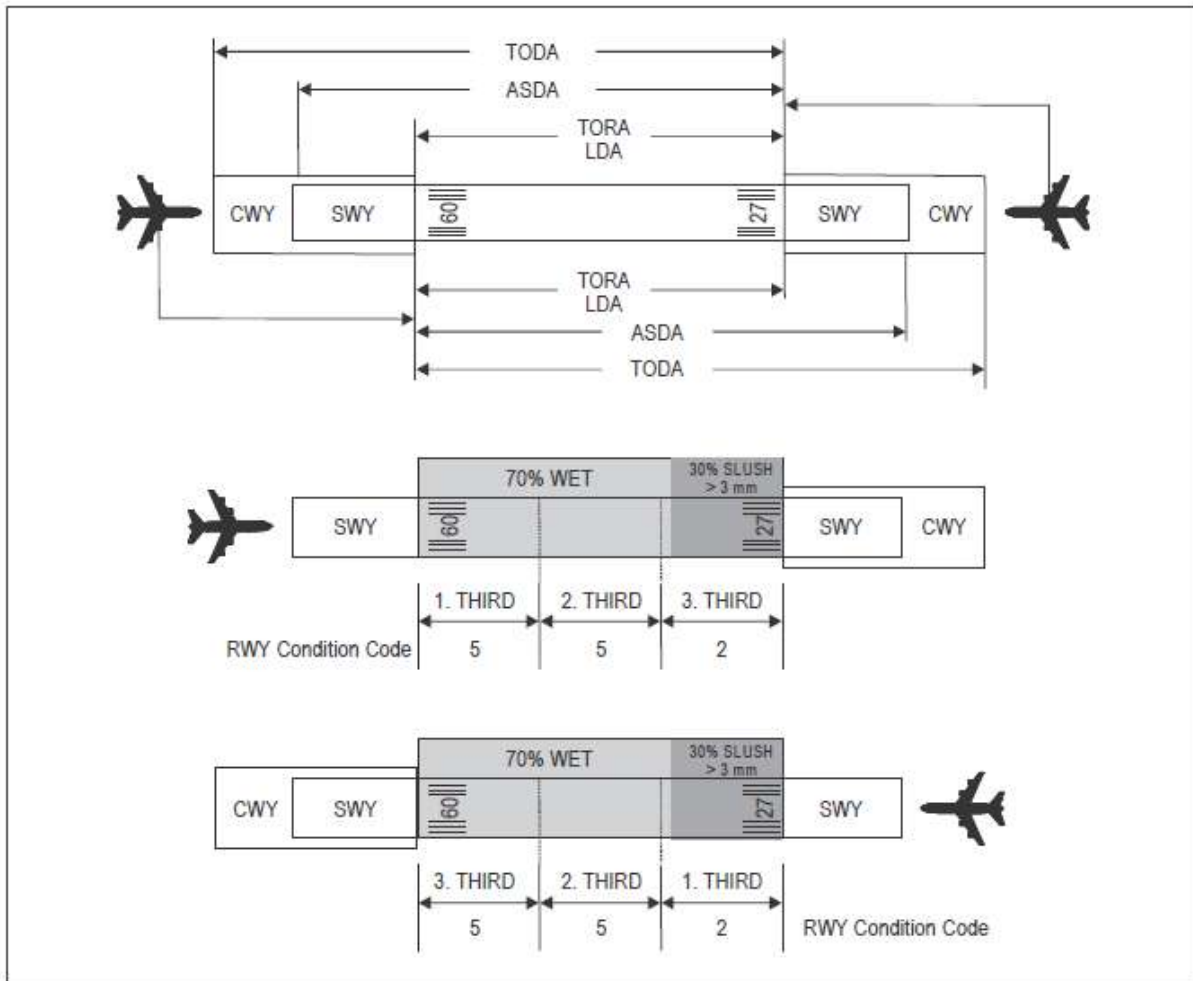
<sup>2</sup>The Aerodrome operator may assign a higher runway condition code (but no higher than code 3) for each third of the runway, provided the procedure in 1.1.3.15 of ICAO Doc 9981 – PANS-Aerodromes, is followed.

**Table AE-5. Runway condition assessment matrix (RCAM)**

## GACAR PART 139 – CERTIFICATION, AUTHORIZATION AND OPERATION OF AERODROMES

8. List of Figures used in Runway Condition Report

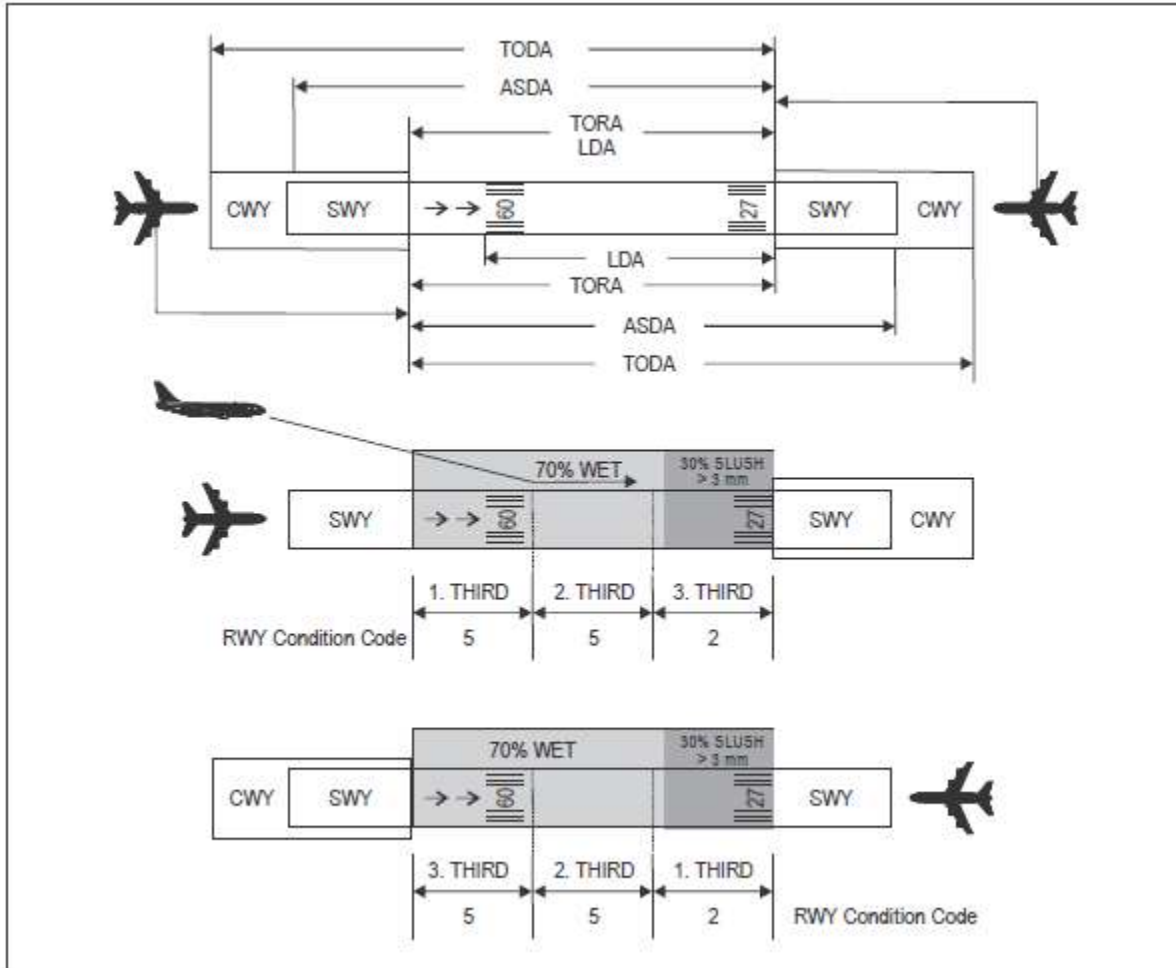
(a) Figure for reporting of runway condition code from ATS to flight crew for runway thirds.



**Figure AE-1. Reporting of runway condition code from ATS to flight crew for runway thirds**

(b) Figure for reporting of runway condition code for runway thirds from ATS to flight crew on a runway with displaced threshold

## GACAR PART 139 – CERTIFICATION, AUTHORIZATION AND OPERATION OF AERODROMES



**Figure AE-2. Reporting of runway condition code for runway thirds from ATS to flight crew on a runway with displaced threshold**

### 9. Format of SNOWTAM

The following format of SNOWTAM must be used. For more details, refer ICAO Doc 10066-PANS-AIM and Doc 9981-PANS-Aerodromes.

## GACAR PART 139 – CERTIFICATION, AUTHORIZATION AND OPERATION OF AERODROMES

App 4-6

Procedures — Aeronautical Information Management

### Appendix 4. SNOWTAM FORMAT

(See Chapter 5, 5.2.5.1.4)

(applicable as of 5 November 2020)

|  |                           |                          |                         |     |                  |  |    |    |
|--|---------------------------|--------------------------|-------------------------|-----|------------------|--|----|----|
| (COM heading)  | (PRIORITY INDICATOR)      | (ADDRESSES)              |                         |     |                  |  | -> |    |
|  | (DATE AND TIME OF FILING) | (ORIGINATOR'S INDICATOR) |                         |     |                  |  | -> |    |
| (Abbreviated heading)  | (SWAA* SERIAL NUMBER)     | (LOCATION INDICATOR)     | DATE/TIME OF ASSESSMENT |     | (OPTIONAL GROUP) |  | -> |    |
| S  | W                         | .                        | .                       |     |                  |  | -> |    |
| SNOWTAM →  |                           | (Serial number)          |                         |     |                  |  |    | -> |
| <b>Aeroplane performance calculation section</b>   |                           |                          |                         |     |                  |  |    |    |
| (AERODROME LOCATION INDICATOR)   |                           | M                        | A)                      |     |                  |  |    | -> |
| (DATE/TIME OF ASSESSMENT (Time of completion of assessment in UTC))  |                           | M                        | B)                      |     |                  |  |    | →  |
| (LOWER RUNWAY DESIGNATION NUMBER)  |                           | M                        | C)                      |     |                  |  |    | →  |
| (RUNWAY CONDITION CODE (RWYCC) ON EACH-RUNWAY THIRD)<br><small>(From Runway Condition Assessment Matrix (RCAM) 0, 1, 2, 3, 4, 5 or 0)</small>  |                           | M                        | D)                      | / / |                  |  |    | →  |
| (PER CENT COVERAGE CONTAMINANT FOR EACH RUNWAY THIRD)  |                           | C                        | E)                      | / / |                  |  |    | →  |
| (DEPTH (mm) OF LOOSE CONTAMINANT FOR EACH RUNWAY THIRD)  |                           | C                        | F)                      | / / |                  |  |    | →  |
| (CONDITION DESCRIPTION OVER TOTAL RUNWAY LENGTH)<br><small>(Observed on each runway third, starting from threshold having the lower runway designation number)</small>   |                           | M                        | G)                      | / / |                  |  |    | →  |
| COMPACTED SNOW<br>DRY<br>DRY SNOW<br>DRY SNOW ON TOP OF COMPACTED SNOW<br>DRY SNOW ON TOP OF ICE<br>FROST<br>ICE<br>SLUSH<br>STANDING WATER<br>WATER ON TOP OF COMPACTED SNOW<br>WET<br>WET ICE<br>WET SNOW<br>WET SNOW ON TOP OF COMPACTED SNOW<br>WET SNOW ON TOP OF ICE   |                           |                          |                         |     |                  |  |    | →  |
| (WIDTH OF RUNWAY TO WHICH THE RUNWAY CONDITION CODES APPLY, IF LESS THAN PUBLISHED WIDTH)  |                           | O                        | H)                      |     |                  |  |    | -> |
| <b>Situational awareness section</b>   |                           |                          |                         |     |                  |  |    |    |
| (REDUCED RUNWAY LENGTH, IF LESS THAN PUBLISHED LENGTH (m))   |                           | O                        | I)                      |     |                  |  |    | →  |
| (DRIFTING SNOW ON THE RUNWAY)  |                           | O                        | J)                      |     |                  |  |    | →  |
| (LOOSE SAND ON THE RUNWAY)   |                           | O                        | K)                      |     |                  |  |    | →  |
| (CHEMICAL TREATMENT ON THE RUNWAY)   |                           | O                        | L)                      |     |                  |  |    | →  |
| (SNOWBANKS ON THE RUNWAY)<br><small>(If present, distance from runway centre line (m) followed by "L", "R" or "LR" as applicable)</small>  |                           | O                        | M)                      |     |                  |  |    | →  |
| (SNOWBANKS ON A TAXIWAY)   |                           | O                        | N)                      |     |                  |  |    | →  |
| (SNOWBANKS ADJACENT TO THE RUNWAY)   |                           | O                        | O)                      |     |                  |  |    | →  |
| (TAXIWAY CONDITIONS)   |                           | O                        | P)                      |     |                  |  |    | →  |
| (APRON CONDITIONS)   |                           | O                        | R)                      |     |                  |  |    | →  |
| (MEASURED FRICTION COEFFICIENT)  |                           | O                        | S)                      |     |                  |  |    | →  |
| (PLAIN-LANGUAGE REMARKS)   |                           | O                        | T)                      |     |                  |  |    | )  |
| NOTES:<br>1. *Enter ICAO nationality letters as given in ICAO Doc 7910, Part 2 or otherwise applicable aerodrome identifier.<br>2. Information on other runways, repeat from B to H.<br>3. Information in the situational awareness section repeated for each runway, taxiway and apron. Repeat as applicable when reported.<br>4. Words in brackets ( ) not to be transmitted.<br>5. For letters A) to T) refer to the instructions for the completion of the SNOWTAM Format, paragraph 1, Item b). |                           |                          |                         |     |                  |  |    |    |

SIGNATURE OF ORIGINATOR (not for transmission)

**Figure AE-3. SNOWTAM FORMAT**

**GACAR PART 139 – CERTIFICATION, AUTHORIZATION AND OPERATION OF  
AERODROMES**

---

**APPENDIX E-4.**

Reserved.



---

## GACAR PART 139 – CERTIFICATION, AUTHORIZATION AND OPERATION OF AERODROMES

---

### APPENDIX E-5. Drainage characteristics of the movement area and adjacent areas

#### I. General

1. Rapid drainage of surface water is a primary safety consideration in the design, construction and maintenance of the movement area and adjacent areas. The objective is to minimize water depth on the surface by draining water off the runway in the shortest path possible and particularly out of the area of the wheel path. There are two distinct drainage processes taking place:
  - a. natural drainage of the surface water from the top of the pavement surface until it reaches the final recipient such as rivers or other water bodies; and
  - b. Dynamic drainage of the surface water trapped under a moving tire until it reaches outside the tire-to-ground contact area.
2. Both processes can be controlled through:
  - a. design;
  - b. construction; and
  - c. maintenance.

of the pavements in order to prevent accumulation of water on the pavement surface.

#### II. Design of pavement

1. Surface drainage is a basic requirement and serves to minimize water depth on the surface. The objective is to drain water off the runway in the shortest path. Adequate surface drainage is provided primarily by an appropriately sloped surface (in both the longitudinal and transverse directions). The resulting combined longitudinal and transverse slope is the path for the drainage run-off. This path can be shortened by adding transverse grooves.
2. Dynamic drainage is achieved through built-in texture in the pavement surface. The rolling tire builds up water pressure and squeezes the water out the escape channels provided by the texture. The dynamic drainage of the tire-to-ground contact area may be improved by adding transverse grooves provided that they are subject to rigorous maintenance.

#### III. Construction of pavement

1. Through construction, the drainage characteristics of the surface are built into the pavement. These surface characteristics are:
  - (i) slopes;
  - (ii) texture:
    - (A) micro texture; and
    - (B) Macrottexture.

## GACAR PART 139 – CERTIFICATION, AUTHORIZATION AND OPERATION OF AERODROMES

2. Slopes for the various parts of the movement area and adjacent parts are described in SUBPART F and figures are given as per cent. Further guidance is given in the ICAO Aerodrome Design Manual (Doc 9157), Part 1, Chapter 5.
3. Texture in the literature is described as micro texture or macrottexture. These terms are understood differently in various parts of the aviation industry.
4. Micro texture is the texture of the individual stones and is hardly detectable by the eye. Micro texture is considered a primary component in skid resistance at slow speeds. On a wet surface at higher speeds a water film may prevent direct contact between the surface asperities and the tire due to insufficient drainage from the tire-to-ground contact area.
5. Macrottexture is a built-in quality of the pavement surface. By specifying crushed material that will withstand polishing micro texture, drainage of thin water films is ensured for a longer period of time. Resistance against polishing is expressed in terms of the Polished Stone Values (PSV) which is in principle a value obtained from a friction measurement in accordance with international standards. These standards define the PSV minima that will enable a material with a good micro texture to be selected.
6. A major problem with micro texture is that it can change within short time periods without being easily detected. A typical example of this is the accumulation of rubber deposits in the touchdown area which will largely mask micro texture without necessarily reducing macrottexture.
7. Macrottexture is the texture among the individual stones. This scale of texture may be judged approximately by the eye. Macrottexture is primarily created by the size of aggregate used or by surface treatment of the pavement and is the major factor influencing drainage capacity at high speeds. Materials shall be selected so as to achieve good macrottexture.
8. The primary purpose of grooving a runway surface is to enhance surface drainage. Natural drainage can be slowed down by surface texture, but grooving can speed up the drainage by providing a shorter drainage path and increasing the drainage rate.
9. For measurement of macrottexture, simple methods such as the “sand and grease patch” methods described in the Airport Services Manual (Doc 9137), Part 2 were developed. These methods were used for the early research on which current airworthiness requirements are based, which refer to a classification categorizing macrottexture from A to E. This classification was developed, using sand or grease patch measuring techniques, and issued in 1971 by the Engineering Sciences Data Unit (ESDU).

*Runway classification based on texture information from ESDU 71026:*

| <i>Classification</i> | <i>Texture depths (mm)</i> |
|-----------------------|----------------------------|
| A                     | 0.10 – 0.14                |
| B                     | 0.15 – 0.24                |
| C                     | 0.25 – 0.50                |
| D                     | 0.51 – 1.00                |
| E                     | 1.01 – 2.54                |

---

## GACAR PART 139 – CERTIFICATION, AUTHORIZATION AND OPERATION OF AERODROMES

---

10. Using this classification, the threshold value between micro texture and macrotexture is 0.1 mm mean texture depth (MTD). Related to this scale, the normal wet runway aircraft performance is based upon texture giving drainage and friction qualities midway between classification B and C (0.25 mm). Improved drainage through better texture might qualify for a better aircraft performance class. However, such credit must be in accordance with aeroplane manufacturers' documentation. Presently credit is given to grooved or porous friction course runways following design, construction and maintenance criteria acceptable to the President. The harmonized certification standards refer to texture giving drainage and friction qualities midway between classification D and E (1.0 mm).
11. For construction, design and maintenance, various international standards. Currently ISO 13473-1: Characterization of pavement texture by use of surface profiles — Part 1: Determination of Mean Profile Depth links the volumetric measuring technique with non-contact profile measuring techniques giving comparable texture values. These standards describe the threshold value between micro texture and macrotexture as 0.5 mm. The volumetric method has a validity range from 0.25 to 5 mm MTD. The profilometry method has a validity range from 0 to 5 mm mean profile depth (MPD). The values of MPD and MTD differ due to the finite size of the glass spheres used in the volumetric technique and because the MPD is derived from a two-dimensional profile rather than a three-dimensional surface. Therefore, a transformation equation must be established for the measuring equipment used to relate MPD to MTD.
12. The ESDU scale groups runway surfaces based on macrotexture from A through E, where E represents the surface with best dynamic drainage capacity. The ESDU scale thus reflects the dynamic drainage characteristics of the pavement. Grooving any of these surfaces enhances the dynamic drainage capacity. The resulting drainage capacity of the surface is thus a function of the texture (A through E) and grooving. The contribution from grooving is a function of the size of the grooves and the spacing between the grooves. Aerodromes exposed to heavy or torrential rainfall must ensure that the pavement and adjacent areas have drainage capability to withstand these rainfalls or put limitations on the use of the pavements under such extreme situations. These airports must seek to have the maximum allowable slopes and the use of aggregates providing good drainage characteristics. They should also consider grooved pavements in the E classification to ensure that safety is not impaired.

#### IV. Maintenance of drainage characteristics of pavement

1. Macrotexture does not change within a short time span, but accumulation of rubber can fill up the texture and as such reduce the drainage capacity, which can result in impaired safety. Furthermore, the runway structure may change over time and give unevenness which results in ponding after rainfall. Guidance on rubber removal and unevenness can be found in the Airport Services Manual (Doc 9137), Part 2. Guidance on methods for improving surface texture can be found in the Aerodrome Design Manual (Doc 9157), Part 3.
2. When grooving are used, the condition of the grooves should be regularly inspected to ensure that no deterioration has occurred and that the grooves are in good condition. Guidance on maintenance of

## **GACAR PART 139 – CERTIFICATION, AUTHORIZATION AND OPERATION OF AERODROMES**

---

pavements is available in the Airport Services Manual (Doc 9137), Part 2 — Pavement Surface Conditions and Part 9 — Airport Maintenance Practices and the Aerodrome Design Manual (Doc 9157), Part 2.

3. The pavement may be shot blasted in order to enhance the pavement macrotexture.

---

## GACAR PART 139 – CERTIFICATION, AUTHORIZATION AND OPERATION OF AERODROMES

---

### APPENDIX E-6. Aerodrome mapping data

#### I. Introduction

SUBPART E § 139.203-(b) and § 139.203-(c) relate to the provision of aerodrome mapping data. The aerodrome mapping data features are collected and made available to the aeronautical information services for aerodromes designated by President with consideration of the intended applications. These applications are closely tied to an identified need and operational use where the application of the data would provide a safety benefit or could be used as mitigation of a safety concern.

#### II. Applications

- (a) Aerodrome mapping data include aerodrome geographic information that supports applications which improve the user's situational awareness or supplement surface navigation, thereby increasing safety margins and operational efficiency. With appropriate data element accuracy, these data sets support collaborative decision-making, common situational awareness and aerodrome guidance applications. The data sets are intended to be used in the following air navigation applications:
  - (i) on-board positioning and route awareness including moving maps with own aircraft position, surface guidance and navigation;
  - (ii) traffic awareness including surveillance and runway incursion detection and alerting (such as, respectively, in A-SMGCS levels 1 and 2);
  - (iii) ground positioning and route awareness including situational displays with aircraft and vehicles position and taxi route, surface guidance and navigation (such as A-SMGCS levels 3 and 4);
  - (iv) facilitation of aerodrome-related aeronautical information, including NOTAMs;
  - (v) resource and Aerodrome facility management; and
  - (vi) Aeronautical chart production.
- (b) The data may also be used in other applications such as training/flight simulators and on-board or ground enhanced vision systems (EVS), synthetic vision systems (SVS) and combined vision systems (CVS).

#### III. Determination of aerodromes to be considered for collection of aerodrome mapping data features.

In order to determine which aerodromes may make use of applications requiring the collection of aerodrome mapping data features, the following aerodrome characteristics may be considered:

## **GACAR PART 139 – CERTIFICATION, AUTHORIZATION AND OPERATION OF AERODROMES**

---

- (i) safety risks at the aerodrome;
- (ii) visibility conditions;
- (iii) aerodrome layout; and
- (iv) traffic density.

*Note. — Further guidance on Aerodrome mapping data can be found in the Airport Services Manual, Part 8 — Airport Operational Service (Doc 9137).*

---

## GACAR PART 139 – CERTIFICATION, AUTHORIZATION AND OPERATION OF AERODROMES

---

### APPENDIX F - PHYSICAL CHARACTERISTICS

#### APPENDIX F-1. Number, siting and orientation of runways

##### (1) Siting and orientation of runways

1.1 Many factors must be taken into account in the determination of the siting and orientation of runways. Without attempting to provide an exhaustive list of these factors nor an analysis of their effects, it appears useful to indicate those which most frequently require study. These factors may be classified under four headings:

###### 1.1.1 Type of operation.

Attention must be paid in particular to whether the Aerodrome is to be used in all meteorological conditions or only in visual meteorological conditions, and whether it is intended for use by day and night, or only by day.

###### 1.1.2 Climatological conditions.

A study of the wind distribution must be made to determine the usability factor. In this regard, the following comments must be taken into account:

1. Wind statistics used for the calculation of the usability factor are normally available in ranges of speed and direction, and the accuracy of the results obtained depends, to a large extent, on the assumed distribution of observations within these ranges. In the absence of any sure information as to the true distribution, it is usual to assume a uniform distribution since, in relation to the most favourable runway orientations, this generally results in a slightly conservative usability factor.
2. The maximum mean crosswind components given in Chapter C, §139.301-(a) - (3), refer to normal circumstances. There are some factors which may require that a reduction of those maximum values be taken into account at a particular aerodrome. These include:
  - (A) The wide variations which may exist, in handling characteristics and maximum permissible crosswind components, among diverse types of aeroplanes (including future types) within each of the three groups given in §139.301-(a) -(3);
  - (B) Prevalence and nature of gusts;
  - (C) Prevalence and nature of turbulence;

---

## GACAR PART 139 – CERTIFICATION, AUTHORIZATION AND OPERATION OF AERODROMES

---

- (D) The availability of a secondary runway;
- (E) The width of runways;
- (F) The runway surface conditions — water, snow and ice on the runway materially reduce the allowable crosswind component; and
- (G) The strength of the wind associated with the limiting crosswind component.

A study must also be made of the occurrence of poor visibility and/or low cloud base. Account must be taken of their frequency as well as the accompanying wind direction and speed.

### 1.1.3 Topography of the Aerodrome site, its approaches, and surroundings, particularly:

- (a) Compliance with the obstacle limitation surfaces;
- (b) Current and future land use. The orientation and layout should be selected so as to protect as far as possible the particularly sensitive areas such as residential, school and hospital zones from the discomfort caused by aircraft noise. Detailed information on this topic is provided in the *Airport Planning Manual* (Doc 9184), Part 2, and in *Guidance on the Balanced Approach to Aircraft Noise Management* (Doc 9829);
- (c) Current and future runway lengths to be provided;
- (d) Construction costs; and
- (e) Possibility of installing suitable non-visual and visual aids for approach-to-land.

### 1.1.4 Air traffic in the vicinity of the Aerodrome, particularly:

- (a) Proximity of other Aerodromes or ATS routes;
- (b) Traffic density; and
- (c) Air traffic control and missed approach procedures.

## (2) Number of runways in each direction

2.1 The number of runways to be provided in each direction depends on the number of aircraft movements to be catered to.



## GACAR PART 139 – CERTIFICATION, AUTHORIZATION AND OPERATION OF AERODROMES

### APPENDIX F-2. Grading of a strip for precision approach runways

As per SUBPART F, §139.307 (e), the portion of a strip of an instrument runway within at least 75 m from the centre line must be graded where the code number is 3 or 4. For a precision approach runway, it may be desirable to adopt a greater width where the code number is 3 or 4. Figure AF-2 (1) shows the shape and dimensions of a wider strip that may be considered for such a runway. The portion to be graded extends to a distance of 105 m from the centre line, except that the distance is gradually reduced to 75 m from the centre line at both ends of the strip, for a length of 150 m from the runway end.

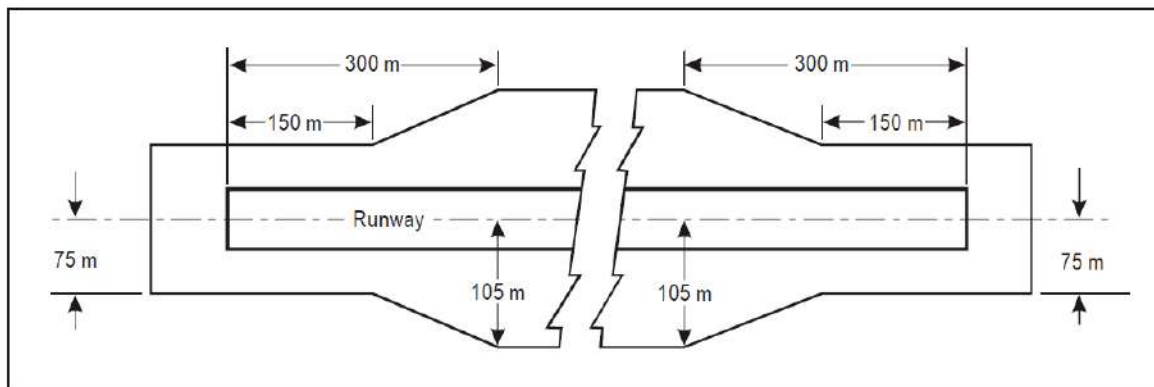


Figure AF-2 (1). Graded portion of a strip including a precision approach runway where the code number is 3 or 4.

## **GACAR PART 139 – CERTIFICATION, AUTHORIZATION AND OPERATION OF AERODROMES**

---

### **APPENDIX F-3. Strength of runway strip**

Since the graded portion of a strip is provided to minimize the hazard to an aircraft running off the runway, it must be graded in such a manner as to prevent the collapse of the nose landing gear of the aircraft. The surface must be prepared in such a manner as to provide drag to an aircraft and below the surface, it must have sufficient bearing strength to avoid damage to the aircraft. To meet these divergent needs, the following guidelines are provided for preparing the strip. The soil at a depth of 15 cm below the finished strip surface be prepared to have a bearing strength of California Bearing Ratio (CBR) value of 15 to 20. The intention of this underlying prepared surface is to prevent the nose gear from sinking more than 15 cm. The top 15 cm may be of lesser strength which would facilitate deceleration of aircraft.

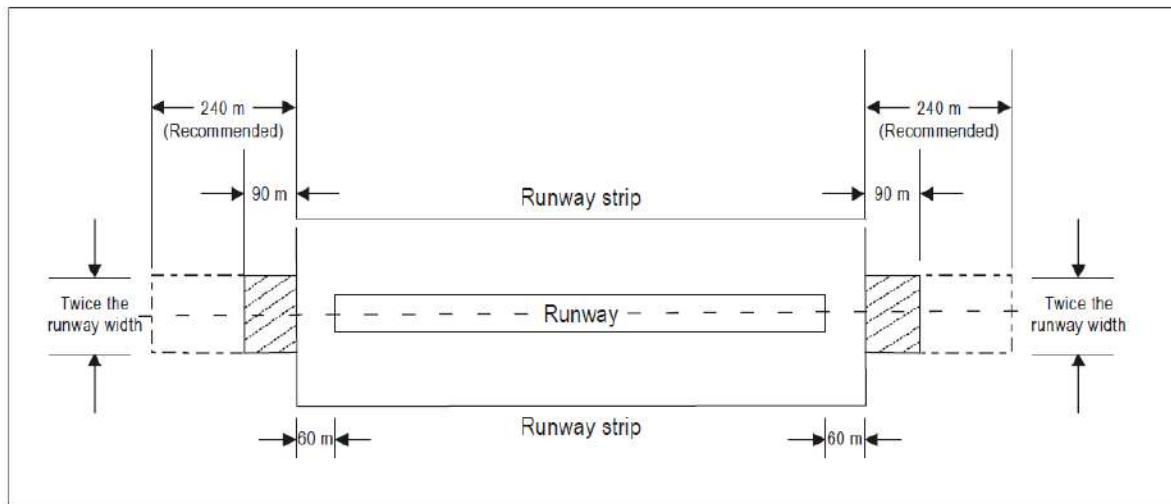
Additional information is contained in the Aerodrome Design Manual (Doc 9157), Part 1.

## GACAR PART 139 – CERTIFICATION, AUTHORIZATION AND OPERATION OF AERODROMES

### APPENDIX F-4. Runway end safety areas (RESA)

Where a runway end safety area is provided in accordance with SUBPART F, consideration must be given to providing an area long enough to contain overruns and undershoots resulting from a reasonably probable combination of adverse operational factors. On a precision approach runway, the ILS localizer is normally the first upstanding obstacle, and the runway end safety area must extend up to this facility. In other circumstances, the first upstanding obstacle may be a road, a railroad or other constructed or natural feature. The provision of a runway end safety area must take such obstacles into consideration.

Additional information is contained in the Aerodrome Design Manual (Doc 9157), Part 1.



**Figure AF-4 (1). Runway end safety area for a runway where the code number is 3 or 4**

## **GACAR PART 139 – CERTIFICATION, AUTHORIZATION AND OPERATION OF AERODROMES**

---

### **APPENDIX F-5. Strength of Runway end safety areas (RESA)**

A runway end safety area must be so prepared or constructed as to reduce the risk of damage to an aeroplane undershooting or overrunning the runway, enhance aeroplane deceleration, and facilitate the movement of rescue and fire fighting vehicles.

**GACAR PART 139 – CERTIFICATION, AUTHORIZATION AND OPERATION OF  
AERODROMES**

---

**APPENDIX G - OBSTACLE RESTRICTION AND REMOVAL**

Reserved.

---

**GACAR PART 139 – CERTIFICATION, AUTHORIZATION AND OPERATION OF  
AERODROMES**

---

**APPENDIX H - VISUAL AIDS FOR NAVIGATION**

**COLORS FOR AERONAUTICAL GROUND LIGHTS, MARKINGS, SIGNS AND PANELS**

**I. General**

Reserved.

**II. Colors for Aeronautical ground lights**

(a) Chromaticities for lights having filament-type light sources

(1) The chromaticities of Aeronautical ground lights with filament-type sources must be within the following boundaries:

CIE Equations (see Figure AH-1):

|   |                 |  |
|---|-----------------|--|
| a | Red             |  |
|   | Purple boundary | $y = 0.980 - x$  |
|   | Yellow boundary | $y = 0.335$ , except for visual approach slope indicator systems |
|   | Yellow boundary | $y = 0.320$ , for visual approach slope indicator systems        |
|   |                 |  |
| b | Yellow          |  |
|   | Red boundary    | $y = 0.382$  |
|   | White boundary  | $y = 0.790 - 0.667x$   |
|   | Green boundary  | $y = x - 0.120$  |
|   |                 |  |
| c | Green           |  |
|   | Yellow boundary | $x = 0.360 - 0.080y$   |
|   | White boundary  | $x = 0.650y$   |
|   | Blue boundary   | $y = 0.390 - 0.171x$   |
|   |                 |  |

## GACAR PART 139 – CERTIFICATION, AUTHORIZATION AND OPERATION OF AERODROMES

|   |                 |  |
|---|-----------------|--|
| d | Blue            |  |
|   | Green boundary  | $y = 0.805x + 0.065$                             |
|   | White boundary  | $y = 0.400 - x$                                  |
|   | Purple boundary | $x = 0.600y + 0.133$                             |
| e | White           |  |
|   | Yellow boundary | $x = 0.500$                                      |
|   | Blue boundary   | $x = 0.285$                                      |
|   | Green boundary  | $y = 0.440$ and $y = 0.150 + 0.640x$             |
|   | Purple boundary | $y = 0.050 + 0.750x$ and $y = 0.382$             |
| f | Variable white  |  |
|   | Yellow boundary | $x = 0.255 + 0.750y$<br>and $y = 0.790 - 0.667x$ |
|   | Blue boundary   | $x = 0.285$                                      |
|   | Green boundary  | $y = 0.440$<br>and $y = 0.150 + 0.640x$          |
|   | Purple boundary | $y = 0.050 + 0.750x$<br>and $y = 0.382$          |

(2) Where dimming is not required, or where observers with defective color vision must be able to determine the color of the light, green signals must be within the following boundaries:

(i) Yellow boundary  $y = 0.726 - 0.726x$

(ii) White boundary  $x = 0.650y$

(iii) Blue boundary  $y = 0.390 - 0.171x$

(3) Where increased certainty of recognition from white is more important than maximum visual range, green signals must be within the following boundaries:

(i) Yellow boundary  $y = 0.726 - 0.726x$

(ii) White boundary  $x = 0.625y - 0.041$

(iii) Blue boundary  $y = 0.390 - 0.171x$

## GACAR PART 139 – CERTIFICATION, AUTHORIZATION AND OPERATION OF AERODROMES

(b) Discrimination between lights having filament-type sources:

- (1) If there is a requirement to discriminate yellow and white from each other, they must be displayed in close proximity of time or space as, for example, by being flashed successively from the same beacon.
- (2) If there is a requirement to discriminate yellow from green and/or white, as for example on exit taxiway center line lights, the y coordinates of the yellow light must not exceed a value of 0.40.
- (3) The color variable white is intended to be used only for lights that are to be varied in intensity, e.g. to avoid dazzling. If this color is to be discriminated from yellow, the lights must be so designed and operated that:
  - (i) The x coordinate of the yellow is at least 0.050 greater than the x coordinate of the white; and
  - (ii) The disposition of the lights will be such that the yellow lights are displayed simultaneously and in close proximity to the white lights.

(c) Chromaticities for lights having a solid-state light source:

- (1) The chromaticities of Aeronautical ground lights with solid state light sources e.g. LEDs, must be within the following boundaries:

CIE Equations (see Figure AH-2):

|    |                 |  |
|----|-----------------|--|
| a. | Red             |  |
|    | Purple boundary | $y = 0.980 - x$  |
|    | Yellow boundary | $y = 0.335$ , except for visual approach slope indicator systems |
|    | Yellow boundary | $y = 0.320$ , for visual approach slope indicator systems        |
| b  | Yellow          |  |
|    | Red boundary    | $y = 0.387$  |
|    | White boundary  | $y = 0.980 - x$  |
|    | Green boundary  | $y = 0.727x + 0.054$   |
|    |                 |  |



## GACAR PART 139 – CERTIFICATION, AUTHORIZATION AND OPERATION OF AERODROMES

|   |                 |   |
|---|-----------------|---|
| c | Green           |   |
|   | Yellow boundary | $x = 0.310$   |
|   | White boundary  | $x = 0.625y - 0.041$  |
|   | Blue boundary   | $y = 0.400$   |
| d | Blue            |   |
|   | Green boundary  | $y = 1.141x - 0.037$  |
|   | White boundary  | $y = 0.400 - y$   |
|   | Purple boundary | $x = 0.134 + 0.590y$  |
| e | White           |   |
|   | Yellow boundary | $x = 0.440$   |
|   | Blue boundary   | $x = 0.320$   |
|   | Green boundary  | $y = 0.150 + 0.643x$  |
|   | Purple boundary | $y = 0.050 + 0.757x$  |
| f | variable white  | The boundaries of variable of white for solid state light sources are those of white above. |

(2) where observers with defective color vision must be able to determine the color of the light, green signals must be within the following boundaries:

(i) Yellow boundary  $y = 0.726 - 0.726x$

(ii) White boundary  $x = 0.625y - 0.041$

(iii) Blue boundary  $y = 0.400$

(3) in order to avoid a large variation of shades of green, if colors within the boundaries below are selected, colors within the boundaries of paragraph (2) must not be used:

(i) Yellow boundary  $y = 0.310$

(ii) White boundary  $x = 0.625y - 0.041$

---

## GACAR PART 139 – CERTIFICATION, AUTHORIZATION AND OPERATION OF AERODROMES

---

(iii) Blue boundary  $y = 0.726 - 0.726x$

(d) Color measurement for filament-type and solid state-type light sources

- (1) The color of aeronautical ground lights must be verified as being within the boundaries specified in Figure AH-1 or AH-2, as appropriate, by measurement at five points within the area limited by the innermost isocandela curve (isocandela diagrams in Appendix H refer), with operation at rated current or voltage. In the case of elliptical or circular isocandela curves, the color measurements must be taken at the center and at the horizontal and vertical limits. In the case of rectangular isocandela curves, the color measurements must be taken at the center and the limits of the diagonals (corners). In addition, the color of the light must be checked at the outermost isocandela curve to ensure that there is no color shift that might cause signal confusion to the pilot.
- (2) In the case of visual approach slope indicators and other light units having a color transition sector, the color must be measured at points in accordance with the paragraph (1), except that the color areas must be treated separately, and no point must be within 0.5 degrees of the transition sector.

### III. Colors for markings, signs and panels

- (a) The chromaticities and luminance factors of ordinary, colors of retro-reflective materials and colors of trans illuminated (internally illuminated) signs and panels must be determined under the following standard conditions:
  - (1) Angle of illumination: 45°;
  - (2) Direction of view: perpendicular to surface; and
  - (3) Illuminant : CIE standard illuminant D<sub>65</sub>.
- (b) The chromaticity and luminance factors of ordinary colors for markings and externally illuminated signs and panels must be within the following boundaries when determined under standard conditions.

CIE Equations (see Figure AH-3):

## GACAR PART 139 – CERTIFICATION, AUTHORIZATION AND OPERATION OF AERODROMES

|    |                  |                      |
|----|------------------|----------------------|
| a  | Red              |                      |
|    | Purple boundary  | $y = 0.345 - 0.051x$ |
|    | White boundary   | $y = 0.910 - x$      |
|    | Orange boundary  | $y = 0.314 + 0.047x$ |
|    | Luminance factor | $\beta = 0.07$ (mnm) |
| b  | Orange           |                      |
|    | Red boundary     | $y = 0.285 + 0.100x$ |
|    | White boundary   | $y = 0.940 - x$      |
|    | Yellow boundary  | $y = 0.250 + 0.220x$ |
|    | Luminance factor | $\beta = 0.20$ (mnm) |
| c  | Yellow           |                      |
|    | Orange boundary  | $y = 0.108 + 0.707x$ |
|    | White boundary   | $y = 0.910 - x$      |
|    | Green boundary   | $y = 1.35x - 0.093$  |
|    | Luminance factor | $\beta = 0.45$ (mnm) |
| d  | White            |                      |
|    | Purple boundary  | $y = 0.010 + x$      |
|    | Blue boundary    | $y = 0.610 - x$      |
|    | Green boundary   | $y = 0.030 + x$      |
|    | Yellow boundary  | $y = 0.710 - x$      |
|    | Luminance factor | $\beta = 0.75$ (mnm) |
| e  | Black            |                      |
|    | Purple boundary  | $y = x - 0.030$      |
|    | Blue boundary    | $y = 0.570 - x$      |
|    | Green boundary   | $y = 0.050 + x$      |
|    | Yellow boundary  | $y = 0.740 - x$      |
|    | Luminance factor | $\beta = 0.03$ (max) |
| f  | Yellowish green  |                      |
|    | Green boundary   | $y = 1.317x + 0.4$   |
|    | White boundary   | $y = 0.910 - x$      |
|    | Yellow boundary  | $y = 0.867x + 0.4$   |
| a) | Green            |                      |

## GACAR PART 139 – CERTIFICATION, AUTHORIZATION AND OPERATION OF AERODROMES

|  |                  |                      |
|--|------------------|----------------------|
|  | Yellow boundary  | $x = 0.313$          |
|  | White boundary   | $y = 0.243 + 0.670x$ |
|  | Blue boundary    | $y = 0.493 - 0.524x$ |
|  | Luminance factor | $\beta = 0.10$ (mnm) |

- (c) The chromaticity and luminance factors of colors of retroreflective materials for markings, signs and panels must be within the following boundaries when determined under standard conditions.

CIE Equations (see Figure AH-4):

|   |                  |                      |
|---|------------------|----------------------|
| a | Red              |                      |
|   | Purple boundary  | $y = 0.345 - 0.051x$ |
|   | White boundary   | $y = 0.910 - x$      |
|   | Orange boundary  | $y = 0.314 + 0.047x$ |
|   | Luminance factor | $\beta = 0.03$ (mnm) |
| b | Orange           |                      |
|   | Red boundary     | $y = 0.265 + 0.205x$ |
|   | White boundary   | $y = 0.910 - x$      |
|   | Yellow boundary  | $y = 0.207 + 0.390x$ |
|   | Luminance factor | $\beta = 0.14$ (mnm) |
| c | Yellow           |                      |
|   | Orange boundary  | $y = 0.160 + 0.540x$ |
|   | White boundary   | $y = 0.910 - x$      |
|   | Green boundary   | $y = 1.35x - 0.093$  |
|   | Luminance factor | $\beta = 0.16$ (mnm) |
| d | White            |                      |
|   | Purple boundary  | $y = x$              |
|   | Blue boundary    | $y = 0.610 - x$      |
|   | Green boundary   | $y = 0.040 + x$      |
|   | Yellow boundary  | $y = 0.710 - x$      |
|   | Luminance factor | $\beta = 0.27$ (mnm) |
| e | Blue             |                      |
|   | Green boundary   | $y = 0.118 + 0.675x$ |
|   | White boundary   | $y = 0.370 - x$      |
|   | Purple boundary  | $y = 1.65x - 0.187$  |

## GACAR PART 139 – CERTIFICATION, AUTHORIZATION AND OPERATION OF AERODROMES

|   |                  |                      |
|---|------------------|----------------------|
|   | Luminance factor | $\beta = 0.01$ (mnm) |
| f | Green            |                      |
|   | Yellow boundary  | $y = 0.711 - 1.22x$  |
|   | White boundary   | $y = 0.243 + 0.670x$ |
|   | Blue boundary    | $y = 0.405 - 0.243x$ |
|   | Luminance factor | $\beta = 0.03$ (mnm) |

- (d) The chromaticity and luminance factors of colors for trans illuminated (internally illuminated) signs and panels must be within the following boundaries when determined under standard conditions.

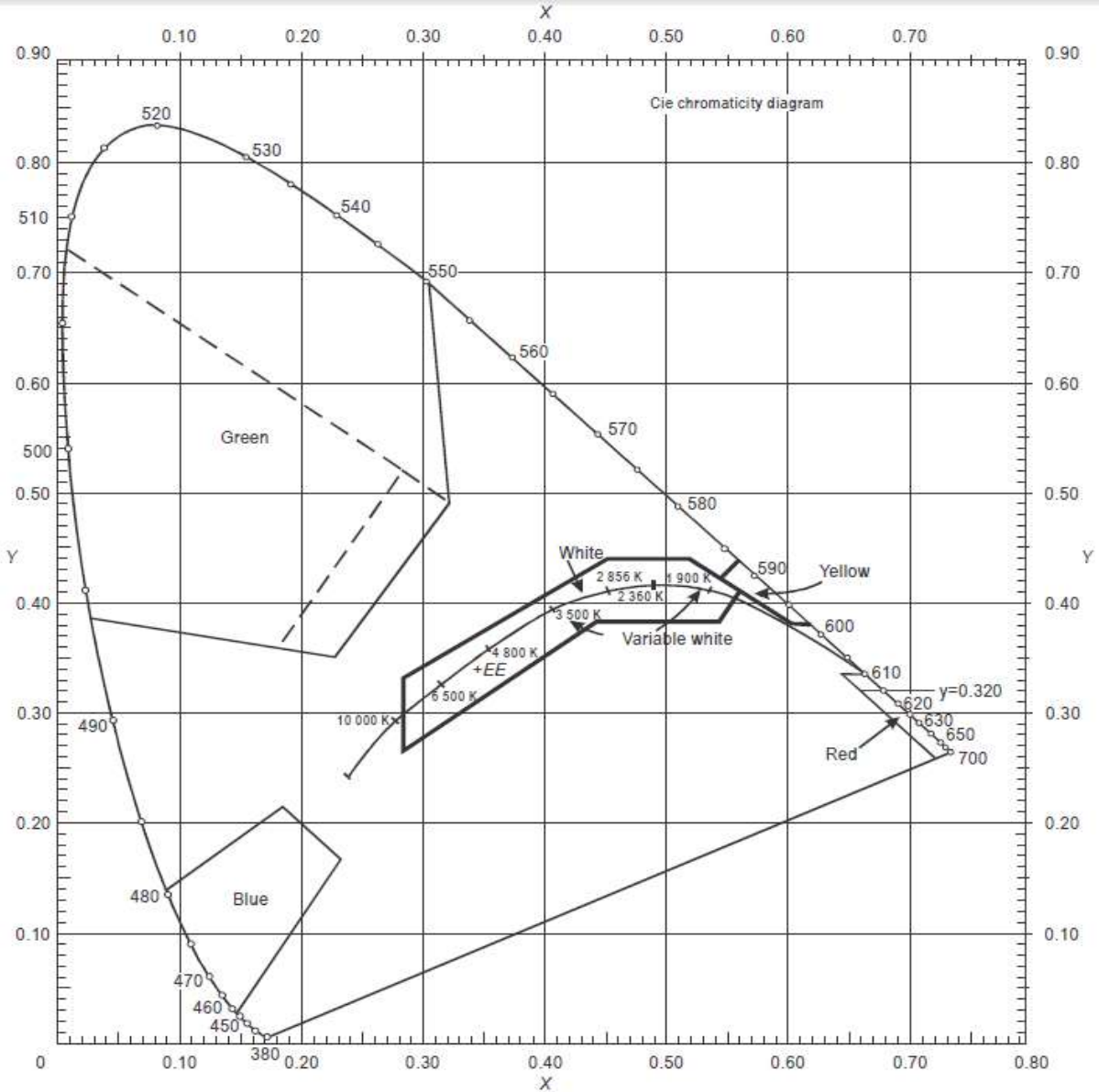
CIE Equations (see Figure AH-5):

|   |   |                        |
|---|---|------------------------|
| a | Red   |                        |
|   | Purple boundary                               | $y = 0.345 - 0.051x$   |
|   | White boundary                                | $y = 0.910 - x$        |
|   | Orange boundary                               | $y = 0.314 + 0.047x$   |
|   | Luminance factor (day condition)              | $\beta = 0.07$ (mnm)   |
|   | Relative luminance to white (night condition) | 5% (mnm)<br>20% (max)  |
| b | Yellow  |                        |
|   | Orange boundary                               | $y = 0.108 + 0.707x$   |
|   | White boundary                                | $y = 0.910 - x$        |
|   | Green boundary                                | $y = 1.35x - 0.093$    |
|   | Luminance factor (day condition)              | $\beta = 0.45$ (mnm)   |
|   | Relative luminance to white (night condition) | 30% (mnm)<br>80% (max) |
| c | White   |                        |
|   | Purple boundary                               | $y = 0.010 + x$        |
|   | Blue boundary                                 | $y = 0.610 - x$        |
|   | Green boundary                                | $y = 0.030 + x$        |
|   | Yellow boundary                               | $y = 0.710 - x$        |
|   | Luminance factor (day condition)              | $\beta = 0.75$ (mnm)   |
|   | Relative luminance to white (night condition) | 100%                   |

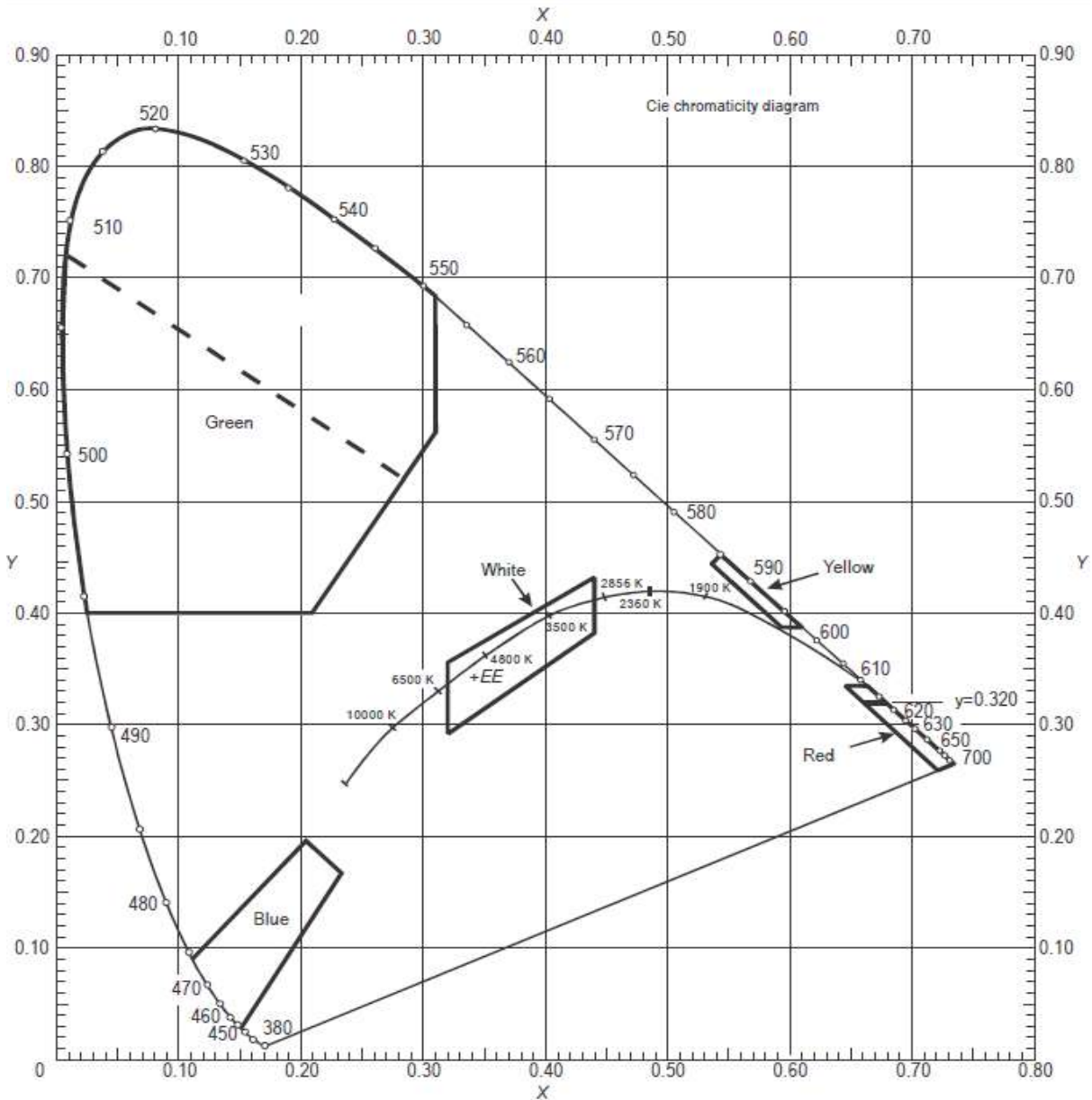
## GACAR PART 139 – CERTIFICATION, AUTHORIZATION AND OPERATION OF AERODROMES

|   |                                  |                                    |
|---|----------------------------------|------------------------------------|
| d | Black                            |                                    |
|   | Purple boundary                  | $y = x - 0.030$                    |
|   | Blue boundary                    | $y = 0.570 - x$                    |
|   | Green boundary                   | $y = 0.030 + x$                    |
|   | Yellow boundary                  | $y = 0.740 - x$                    |
|   | Luminance factor (day condition) | $\beta = 0.03$ (max)               |
|   | Relative luminance               | 0% (mnm)                           |
|   | to white (night condition)       | 2% (max)                           |
| e | Green                            |                                    |
|   | Yellow boundary                  | $x = 0.313$                        |
|   | White boundary                   | $y = 0.243 + 0.670x$               |
|   | Blue boundary                    | $y = 0.493 - 0.524x$               |
|   | Luminance factor                 | $\beta = 0.10$ mnm (day condition) |
|   | Relative luminance               | 5% (mnm)                           |
|   | to white (night conditions)      | 30% (max)                          |

## GACAR PART 139 – CERTIFICATION, AUTHORIZATION AND OPERATION OF AERODROMES

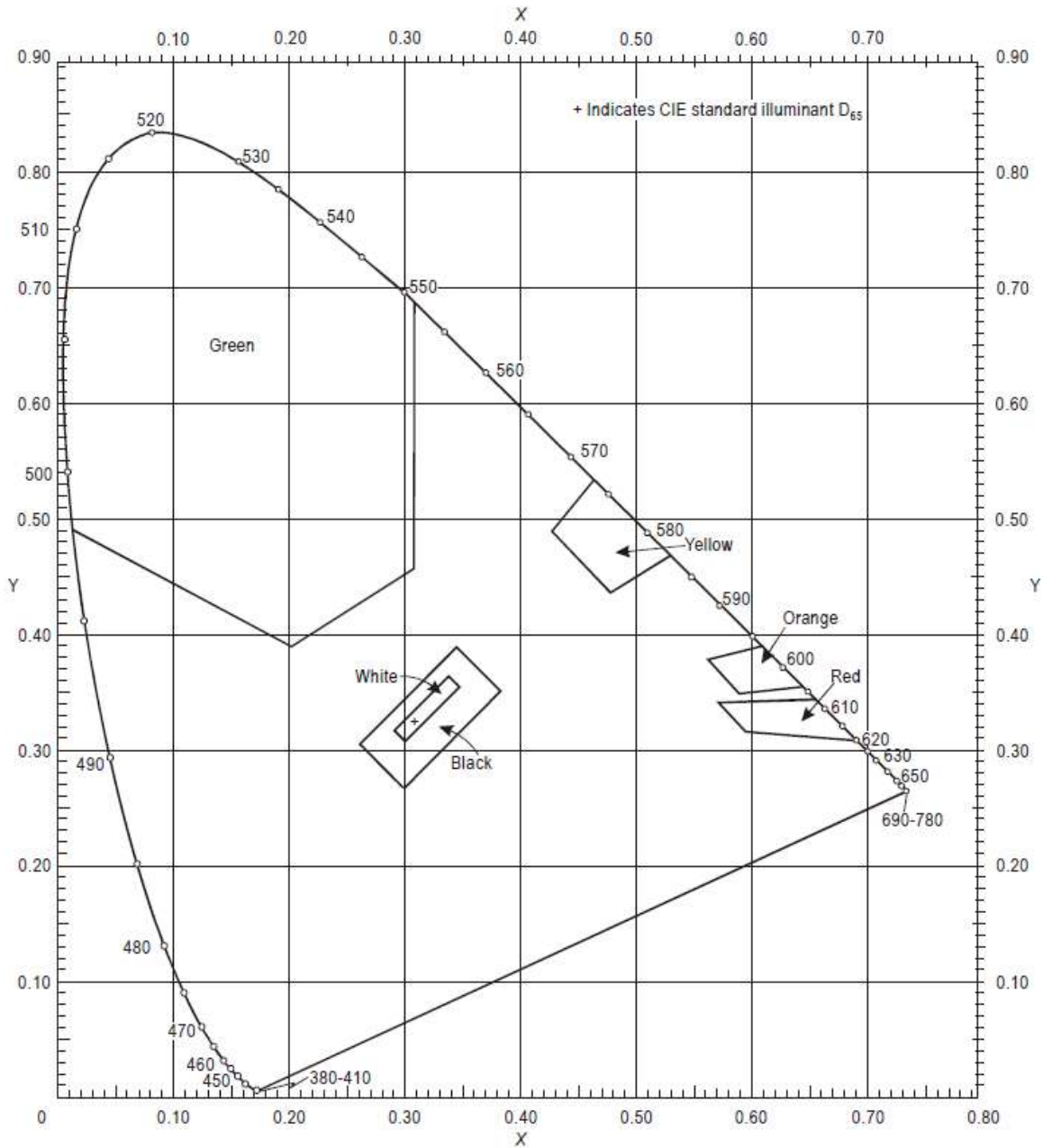


## GACAR PART 139 – CERTIFICATION, AUTHORIZATION AND OPERATION OF AERODROMES

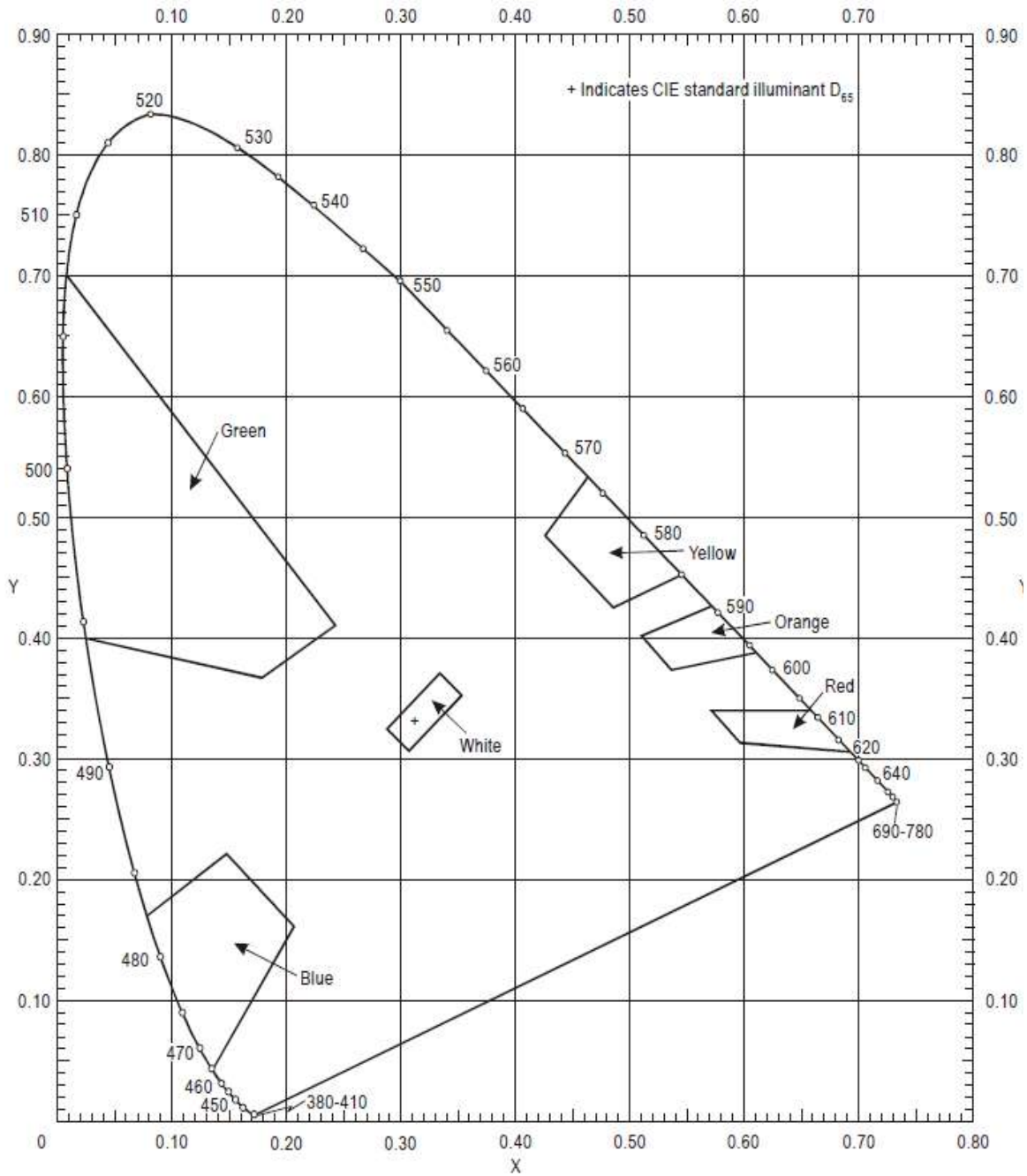




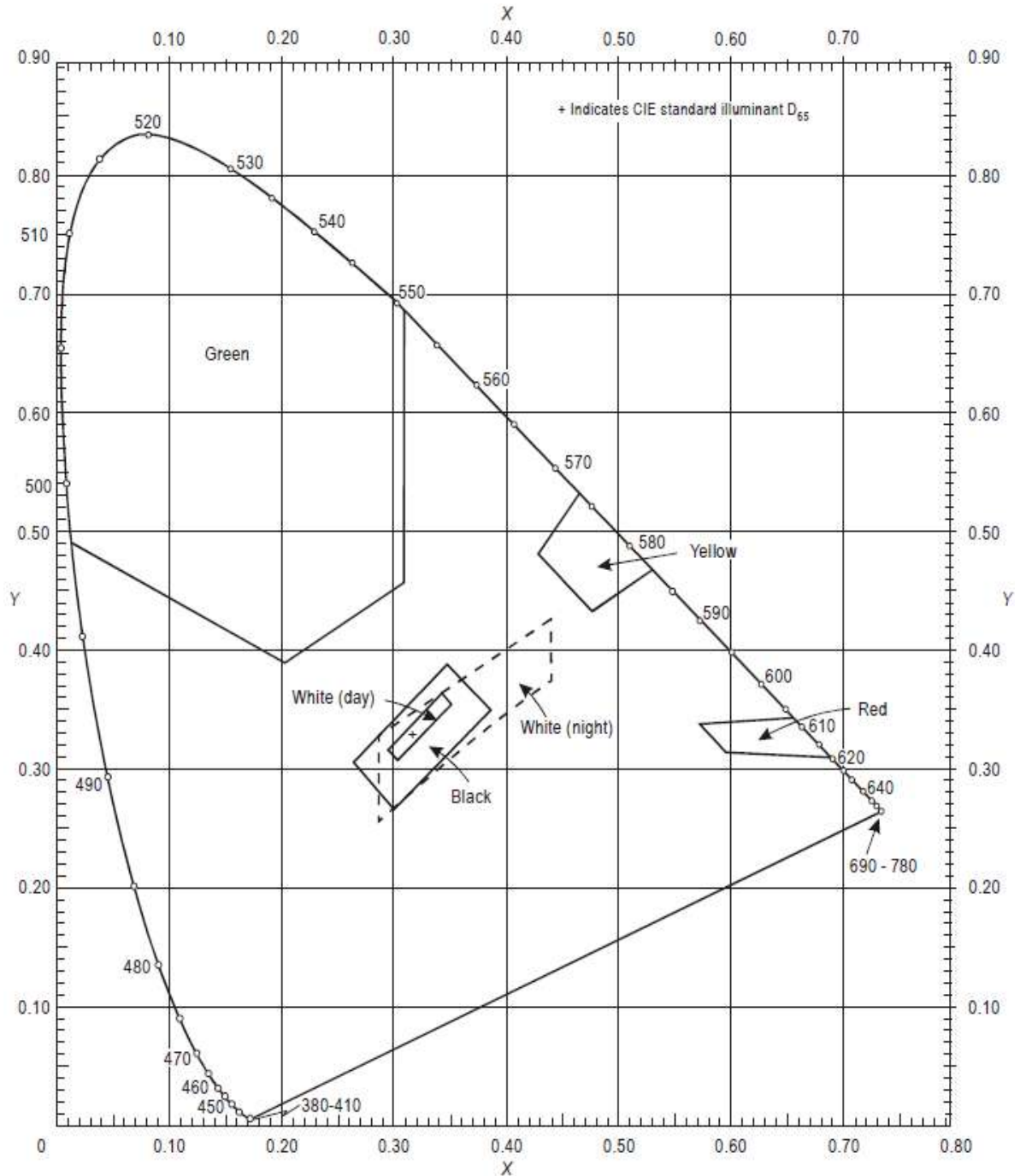
## GACAR PART 139 – CERTIFICATION, AUTHORIZATION AND OPERATION OF AERODROMES



## GACAR PART 139 – CERTIFICATION, AUTHORIZATION AND OPERATION OF AERODROMES

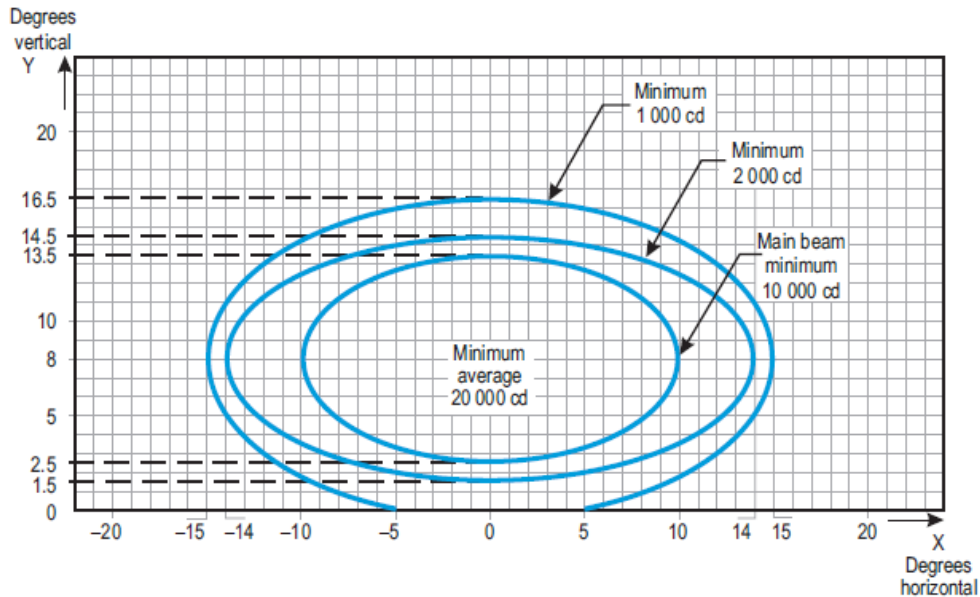


## GACAR PART 139 – CERTIFICATION, AUTHORIZATION AND OPERATION OF AERODROMES



## GACAR PART 139 – CERTIFICATION, AUTHORIZATION AND OPERATION OF AERODROMES

### IV. Aeronautical Ground Light Characteristics



1. Curves Calculated on formula:

$$\frac{x^2}{a^2} + \frac{y^2}{b^2} = 1$$

|   |     |     |     |
|---|-----|-----|-----|
| a | 10  | 14  | 15  |
| b | 5.5 | 6.5 | 8.5 |

2. Vertical Setting angles of the lights must be such that the following vertical coverage of the main beam will be met:

| Distance from threshold | Vertical main distance coverage |
|-------------------------|---------------------------------|
| Threshold to 315m       | 0° – 11°                        |
| 316 m to 475 m          | 0.5° – 11.5°                    |
| 476 m to 640 m          | 1.5° – 12.5°                    |

**GACAR PART 139 – CERTIFICATION, AUTHORIZATION AND OPERATION OF  
AERODROMES**

---

641 m and beyond      2.5 ° – 13.5 ° (as illustrated  
above)

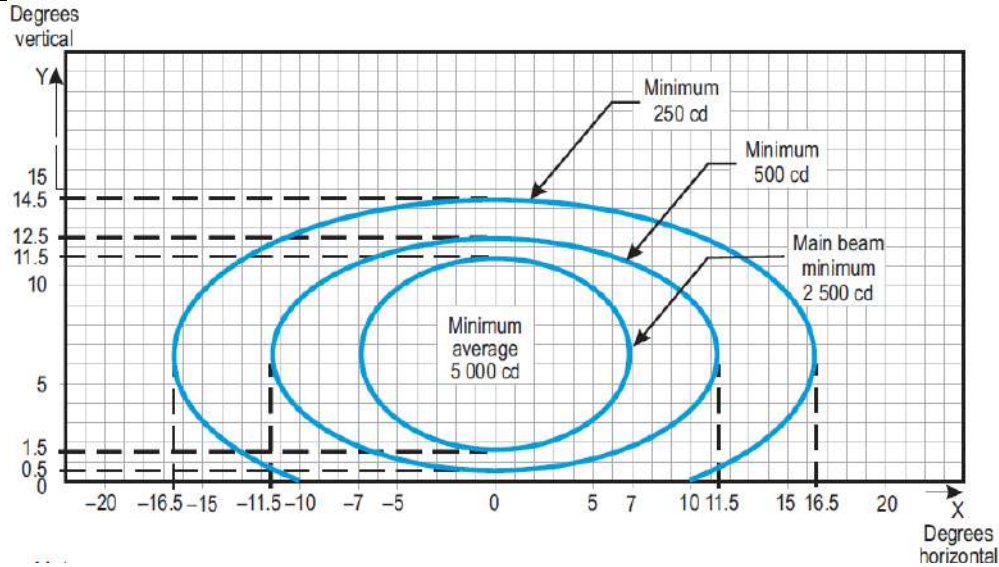
3. Light in crossbars beyond 22.5m from the centre line must be tor-d-in 2 degrees. All other lights must be aligned parallel to the centre of the runway.

4. See collective note for Figures AH-6 to AH-16 and AH-30

---

**Figure AH-6. Isocandela diagram for approach centre line light and crossbars (white light)**

## GACAR PART 139 – CERTIFICATION, AUTHORIZATION AND OPERATION OF AERODROMES



1. Curves Calculated on formula:

$$\frac{x^2}{a^2} + \frac{y^2}{b^2} = 1$$

|   |     |      |      |
|---|-----|------|------|
| a | 7   | 11.5 | 16.5 |
| b | 5.0 | 6.0  | 8.0  |

2. Toe-in in 2 degrees

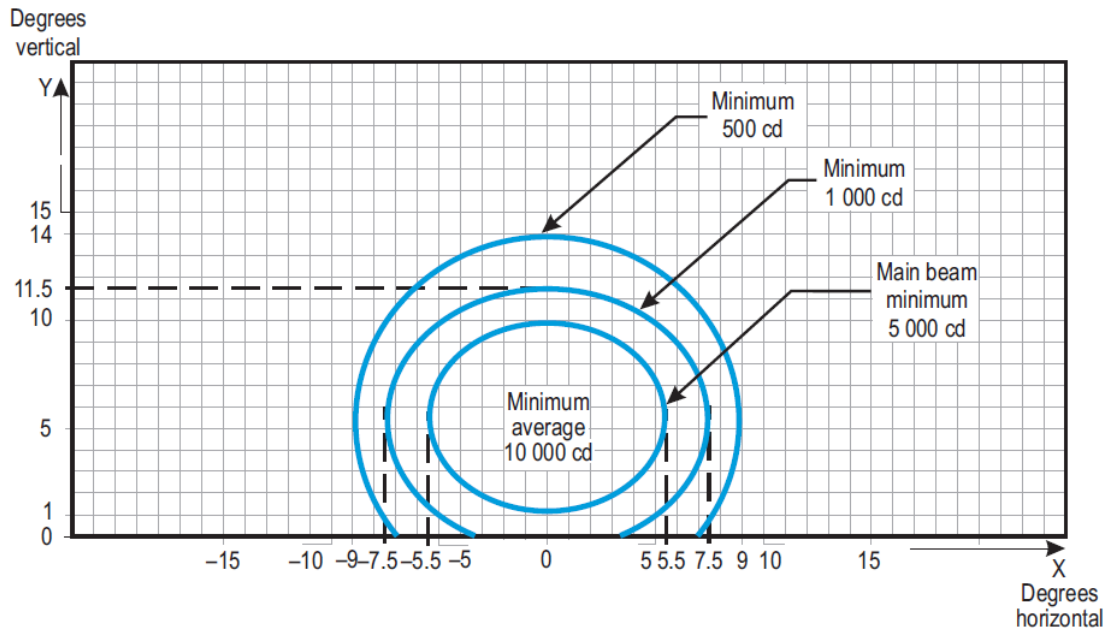
3. Vertical Setting angles of the lights must be such that the following vertical coverage of the main beam will be met:

| Distance from threshold | Vertical main distance coverage     |
|-------------------------|-------------------------------------|
| Threshold to 115m       | 0.5° – 10.5°                        |
| 116 m to 215 m          | 1° – 11°                            |
| 2016 m and beyond       | 1.5° – 11.5° (as illustrated above) |

4. See collective note for Figures AH-6 to AH-16 and AH-30

**Figure AH-7. Isocandela diagram for approach side row light (red light)**

## GACAR PART 139 – CERTIFICATION, AUTHORIZATION AND OPERATION OF AERODROMES



1. Curves Calculated on formula:

$$\frac{x^2}{a^2} + \frac{y^2}{b^2} = 1$$

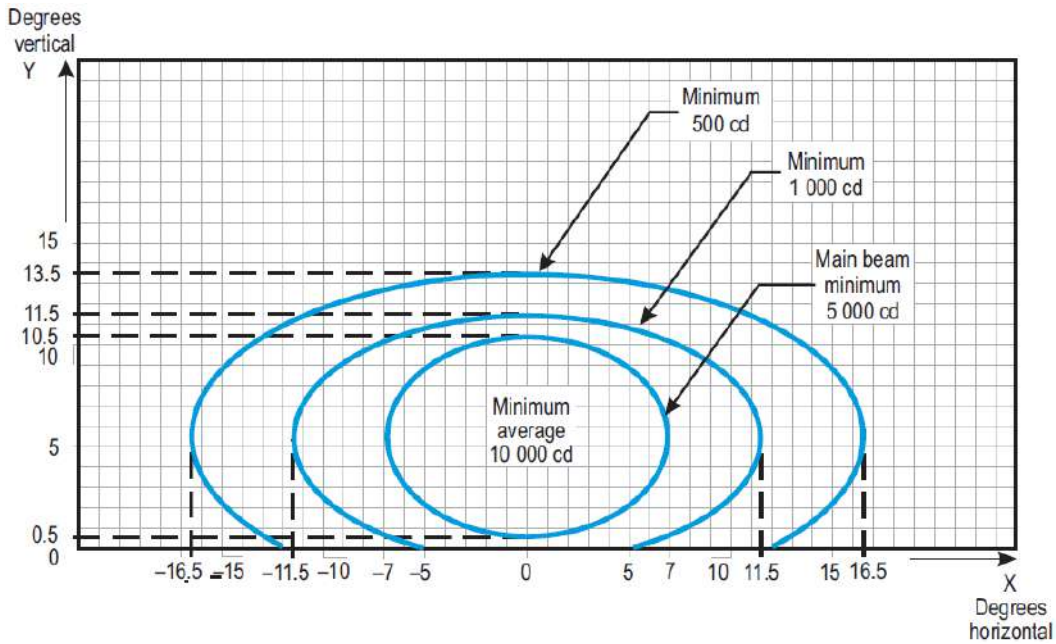
|   |     |     |     |
|---|-----|-----|-----|
| a | 5.5 | 7.5 | 9.0 |
| b | 4.5 | 6.0 | 8.5 |

2. Toe-in in 3 degrees

3. See collective note for Figures AH-6 to AH-16 and AH-30

**Figure AH-8. Isocandela diagram for threshold light (green light)**

## GACAR PART 139 – CERTIFICATION, AUTHORIZATION AND OPERATION OF AERODROMES



1. Curves Calculated on formula:

$$\frac{x^2}{a^2} + \frac{y^2}{b^2} = 1$$

|   |     |      |      |
|---|-----|------|------|
| a | 7.0 | 11.5 | 16.5 |
| b | 5.0 | 6.0  | 8.0  |

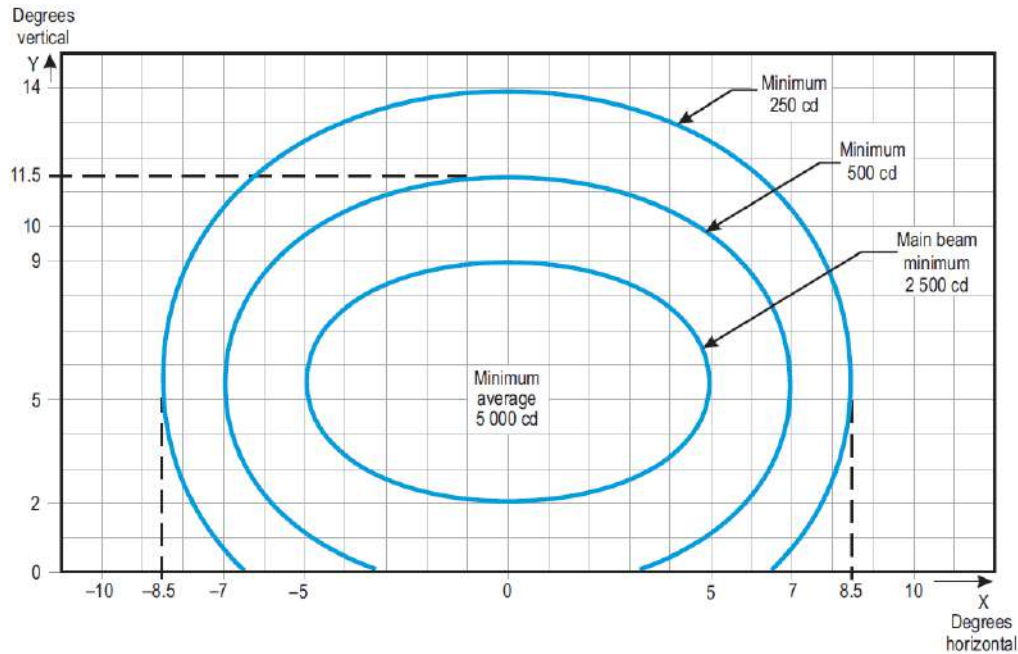
2. Toe-in in 2 degrees

3. See collective note for Figures AH-6 to AH-16 and AH-30

**Figure AH-9. Isocandela diagram for threshold wing bar light (green light)**



## GACAR PART 139 – CERTIFICATION, AUTHORIZATION AND OPERATION OF AERODROMES



1. Curves Calculated on formula:

$$\frac{x^2}{a^2} + \frac{y^2}{b^2} = 1$$

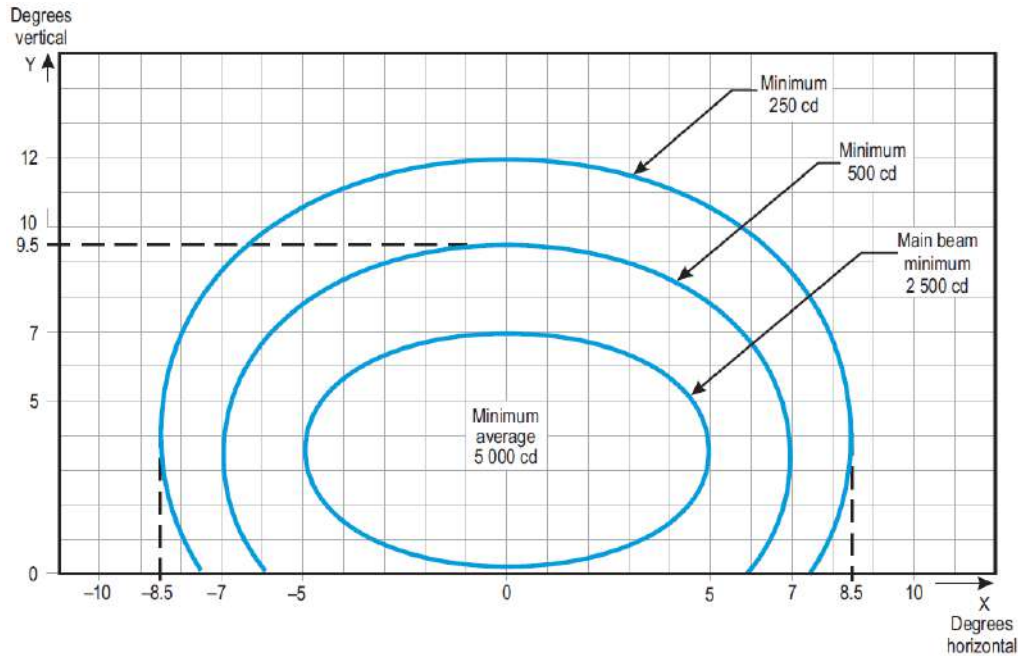
|   |     |     |     |
|---|-----|-----|-----|
| a | 5.0 | 7.0 | 8.5 |
| b | 3.5 | 6.0 | 8.5 |

2. Toe-in in 4 degrees

3. See collective note for Figures AH-6 to AH-16 and AH-30

**Figure AH-10. Isocandela diagram for touchdown zone light (white light)**

## GACAR PART 139 – CERTIFICATION, AUTHORIZATION AND OPERATION OF AERODROMES



1. Curves Calculated on formula:

$$\frac{x^2}{a^2} + \frac{y^2}{b^2} = 1$$

|   |     |     |     |
|---|-----|-----|-----|
| a | 5.0 | 7.0 | 8.5 |
| b | 3.5 | 6.0 | 8.5 |

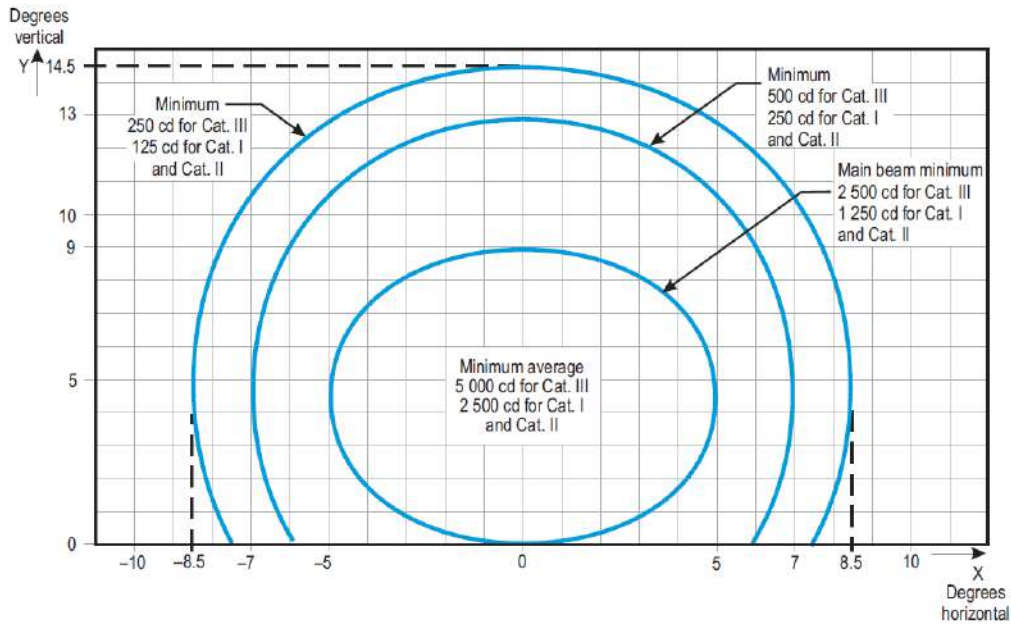
2. For red light, multiple value by 0.15

3. For yellow light, multiple value by 0.40

4. See collective note for Figures AH-6 to AH-16 and AH-30

**Figure AH-11. Isocandela diagram for runway centre line light with 30m longitudinal spacing (white light) and rapid exit taxiway indicator light (yellow light)**

## GACAR PART 139 – CERTIFICATION, AUTHORIZATION AND OPERATION OF AERODROMES



1. Curves Calculated on formula:

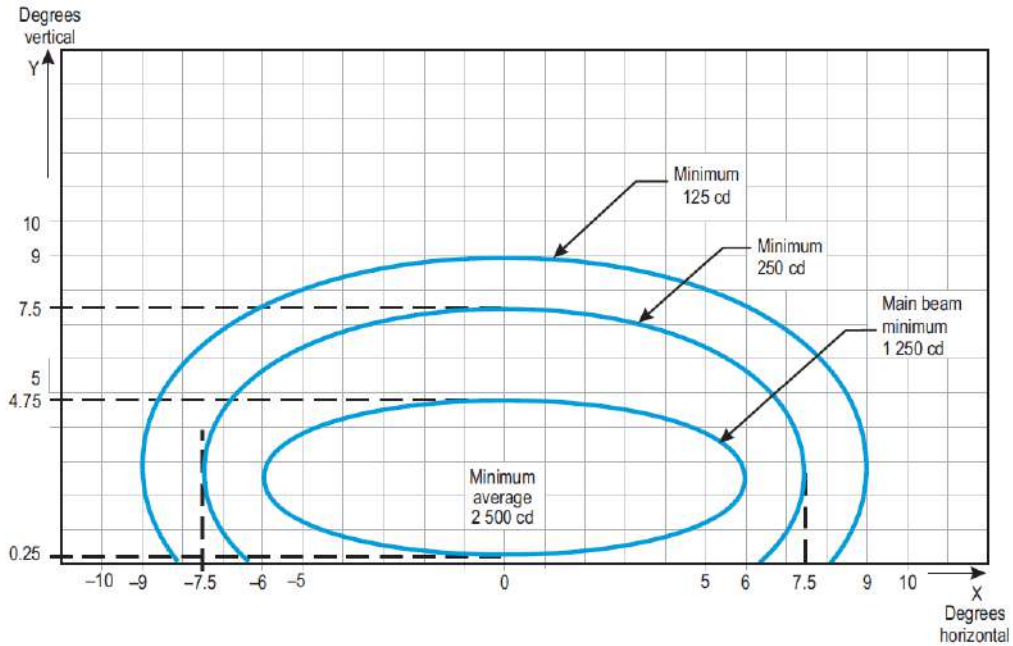
$$\frac{x^2}{a^2} + \frac{y^2}{b^2} = 1$$

|   |     |     |      |
|---|-----|-----|------|
| a | 5.0 | 7.0 | 8.5  |
| b | 4.5 | 8.5 | 10.0 |

2. For red light, multiple value by 0.15
3. For yellow light, multiple value by 0.40
4. See collective note for Figures AH-6 to AH-16 and AH-30

**Figure AH-12. Isocandela diagram for runway centre line light with 15m longitudinal spacing (white light) and rapid exit taxiway indicator light (yellow light)**

## GACAR PART 139 – CERTIFICATION, AUTHORIZATION AND OPERATION OF AERODROMES



1. Curves Calculated on formula:

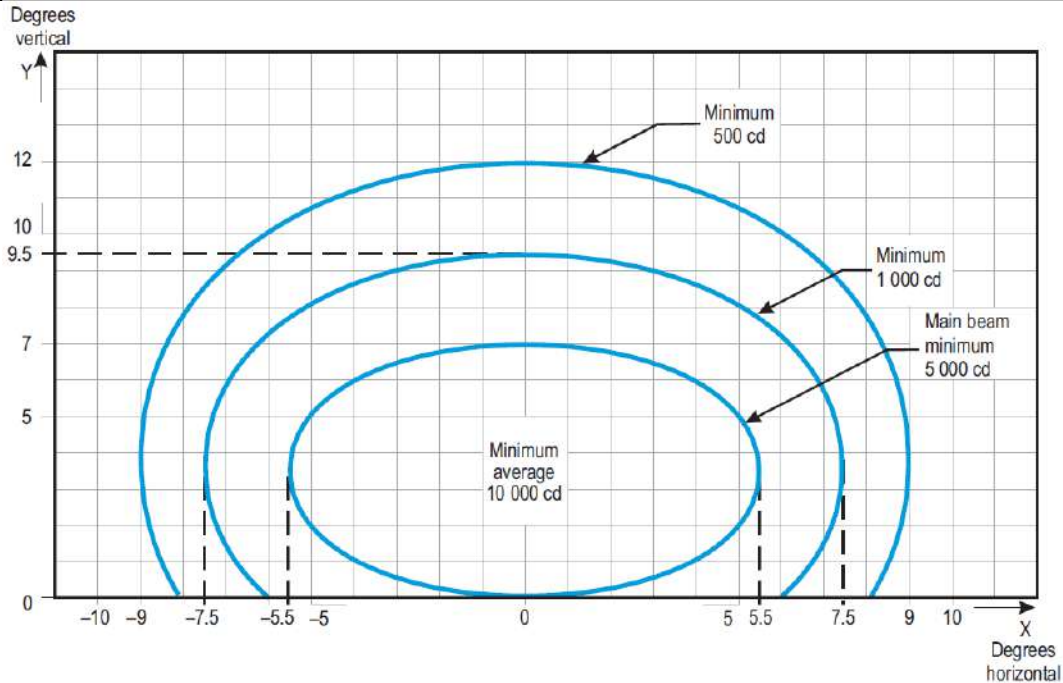
$$\frac{x^2}{a^2} + \frac{y^2}{b^2} = 1$$

|   |      |     |     |
|---|------|-----|-----|
| a | 6.0  | 7.5 | 9.0 |
| b | 2.25 | 5.0 | 6.5 |

4. See collective note for Figures AH-6 to AH-16 and AH-30

### AH-13. Isocandela diagram for runway end light (red light)

## GACAR PART 139 – CERTIFICATION, AUTHORIZATION AND OPERATION OF AERODROMES



1. Curves Calculated on formula:

$$\frac{x^2}{a^2} + \frac{y^2}{b^2} = 1$$

|   |     |     |     |
|---|-----|-----|-----|
| a | 5.5 | 7.5 | 9.0 |
| b | 3.5 | 6.0 | 8.5 |

2. Toe-in in 3.5 degrees

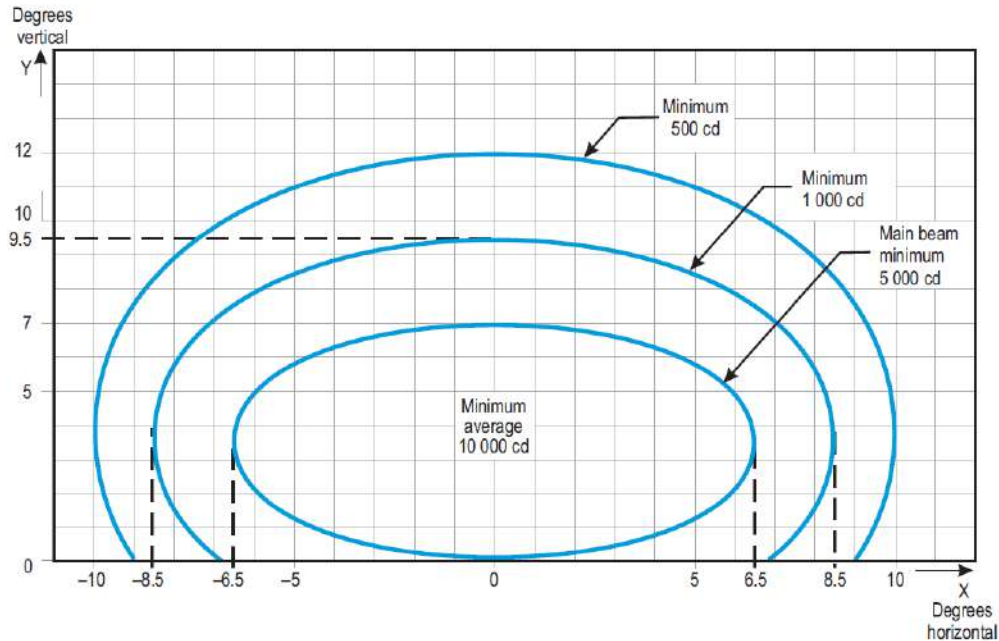
3. For red light, multiple value by 0.15

4. For yellow light, multiple value by 0.40

5. See collective note for Figures AH-6 to AH-16 and AH-30

**Figure AH-14. Isocandela diagram for runway edge light where width of runway is 45m (white light)**

## GACAR PART 139 – CERTIFICATION, AUTHORIZATION AND OPERATION OF AERODROMES



1. Curves Calculated on formula:

$$\frac{x^2}{a^2} + \frac{y^2}{b^2} = 1$$

|   |     |     |      |
|---|-----|-----|------|
| a | 6.5 | 8.5 | 10.0 |
| b | 5.0 | 6.0 | 8.0  |

2. Toe-in in 4.5 degrees

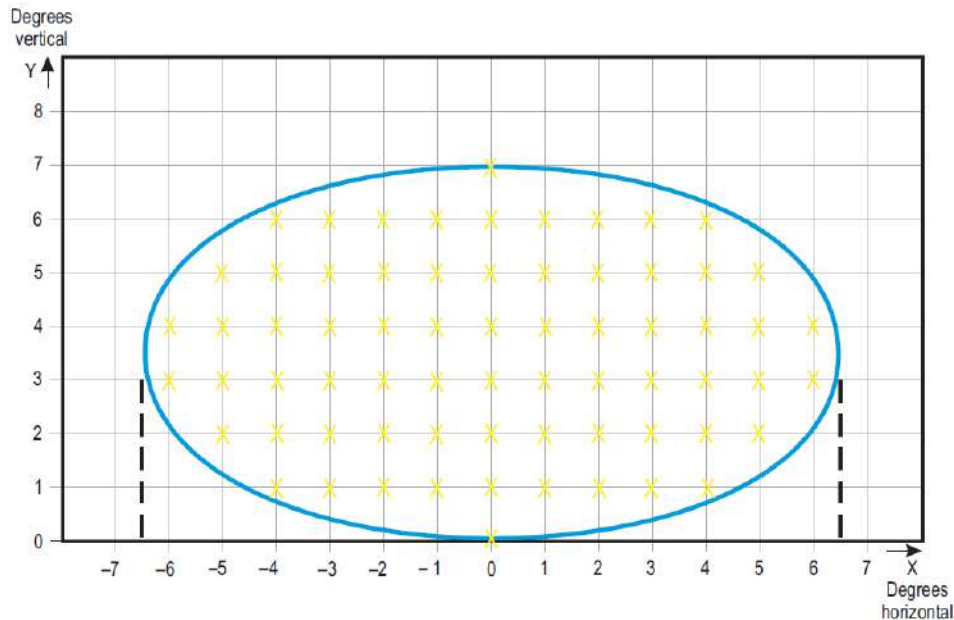
3. For red light, multiple value by 0.15

4. For yellow light, multiple value by 0.40

5. See collective note for Figures AH-6 to AH-16 and AH-30

**Figure AH-15. Isocandela diagram for runway edge light where width of runway is 60m (white light)**

## GACAR PART 139 – CERTIFICATION, AUTHORIZATION AND OPERATION OF AERODROMES



**Figure AH-16. Grid points to be used for calculation of average intensity of approach and runway lights**

a) Collective notes to Figures AH-6 to AH-16 and AH-30

- (1) The ellipses in each figure are symmetrical about the common vertical and horizontal axes.
- (2) Figures AH-6 to AH-15 and AH-30 show the minimum allowable light intensities. The average intensity of the main beam is calculated by establishing grid points as shown in Figure AH-16 and using the intensity values measured at all grid points located within and in the perimeter of the ellipse representing the main beam. The average value is the arithmetic average of light intensities measured at all considered grid points.
- (3) No deviations are acceptable in the main beam pattern when the lighting fixture is properly aimed.
- (4) Average intensity ratio. The ratio between the average intensity within the ellipse defining the main beam of a typical new light and the average light intensity of the main beam of a new runway edge light must be as follows:

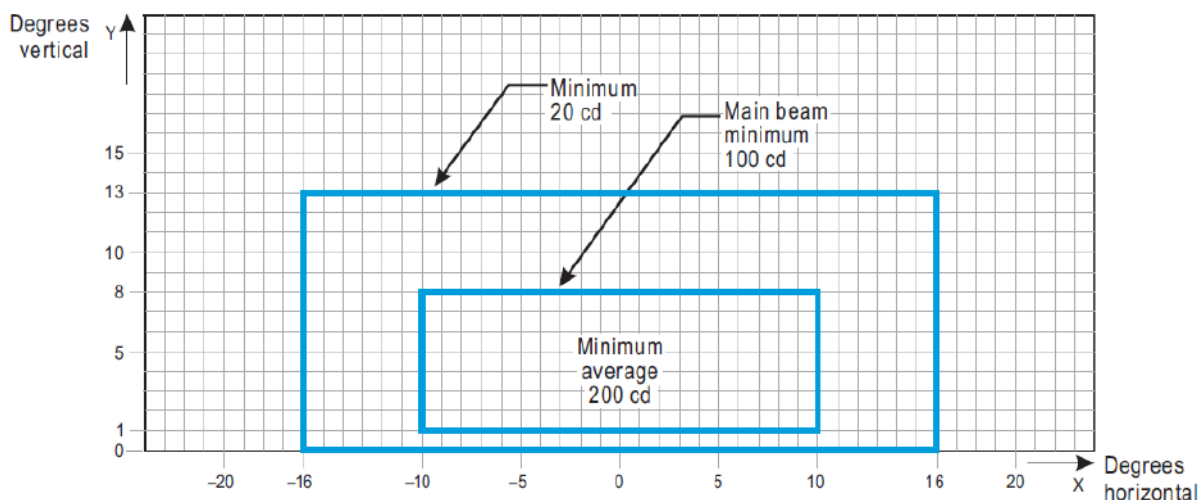
## GACAR PART 139 – CERTIFICATION, AUTHORIZATION AND OPERATION OF AERODROMES

|              |  |   |
|--------------|--|---|
| Figure AH-6  | Approach centre line and crossbars             | 1.5 to 2.0 (white light)                |
| Figure AH-7  | Approach side row                              | 0.5 to 1.0 (red light)                  |
| Figure AH-8  | Threshold                                      | 1.0 to 1.5 (green light)                |
| Figure AH-9  | Threshold wing bar                             | 1.0 to 1.5 (green light)                |
| Figure AH-10 | Touchdown zone                                 | 0.5 to 1.0 (white light)                |
| Figure AH-11 | Runway centre line (longitudinal spacing 30 m) | 0.5 to 1.0 (white light)                |
| Figure AH-12 | Runway centre line (longitudinal spacing 15 m) | 0.5 to 1.0 for CAT III (white light)    |
|              |  | 0.25 to 0.5 for CAT I, II (white light) |
| Figure AH-13 | Runway end                                     | 0.25 to 0.5 (red light)                 |
| Figure AH-14 | Runway edge (45 m runway width)                | 1.0 (white light)                       |
| Figure AH-15 | Runway edge (60 m runway width)                | 1.0 (white light)                       |

- (5) The beam coverage in the figures provides the necessary guidance for approaches down to an RVR of the order of 150 m and take-offs down to an RVR of the order of 100 m.
- (6) Horizontal angles are measured with respect to the vertical plane through the runway centre line. For lights other than center line lights, the direction towards the runway centre line is considered positive. Vertical angles are measured with respect to the horizontal plane.
- (7) Where, for approach center line lights and crossbars and for approach side row lights, inset lights are used in lieu of elevated lights, e.g. on a runway with a displaced threshold, the intensity requirements can be met by installing two or three fittings (lower intensity) at each position.
- (8) The importance of adequate maintenance cannot be over-emphasized. The average intensity must never fall to a value less than 50 per cent of the value shown in the figures and it must be the aim of airport authorities to maintain a level of light output close to the specified minimum average intensity.
- (9) The light unit must be installed so that the main beam is aligned within one-half degree of the specified requirement.



## GACAR PART 139 – CERTIFICATION, AUTHORIZATION AND OPERATION OF AERODROMES



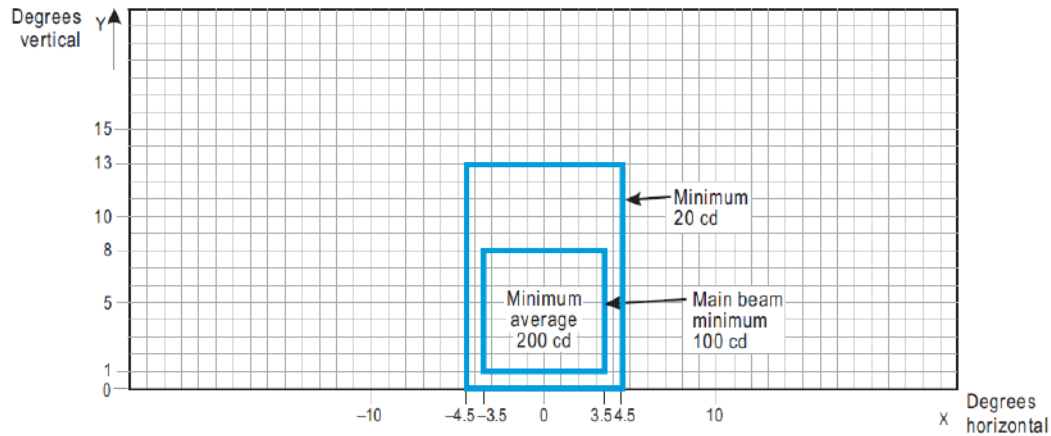
1. These beam coverages allow for displacement of the cockpit from the centre line up to distances of the order of 12 m and are intended for use before and after curves.

See collective notes for Figures AH-17 to AH-26

3. Increased intensities for enhanced rapid exit taxiway centre line lights as recommended in § 139.505-(q) are four times the respective intensities in the figure (i.e. 800 cd for minimum average main beam).

**Figure AH-17. Isocandela diagram for taxiway centre line (15 m spacing), no-entry bar and stop bar lights in straight sections intended for use in runway visual range conditions of less than a value of 350 m where large offsets can occur and for low-intensity runway guard lights, Configuration B**

## GACAR PART 139 – CERTIFICATION, AUTHORIZATION AND OPERATION OF AERODROMES

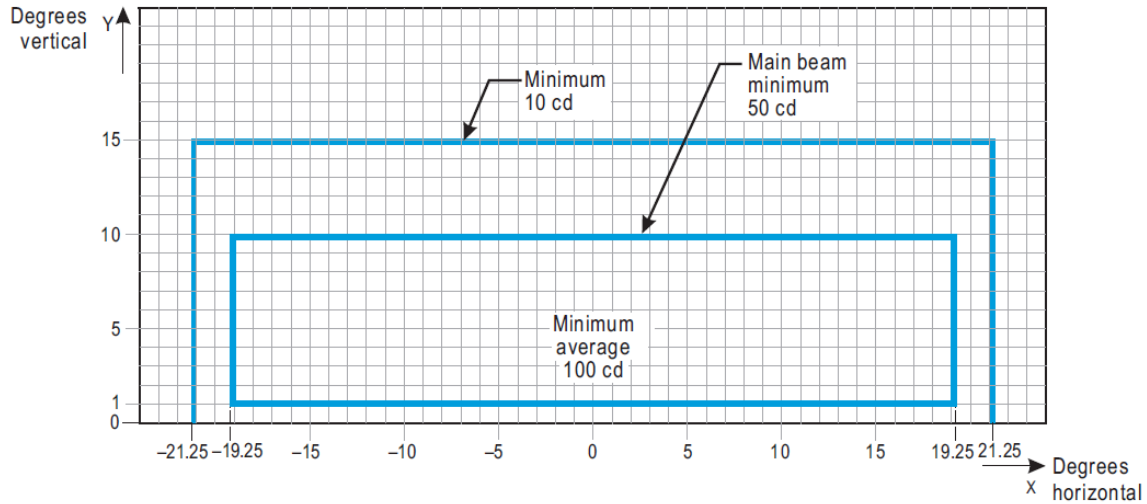


1. These beam coverages are generally satisfactory and cater for a normal displacement of the cockpit from the centre line of approximately 3 m.

2. See collective notes for Figures AH-17 to AH-26

**Figure AH-18. Isocandela diagram for taxiway centre line (15 m spacing), no-entry bar and stop bar lights in straight sections intended for use in runway visual range conditions of less than a value of 350 m**

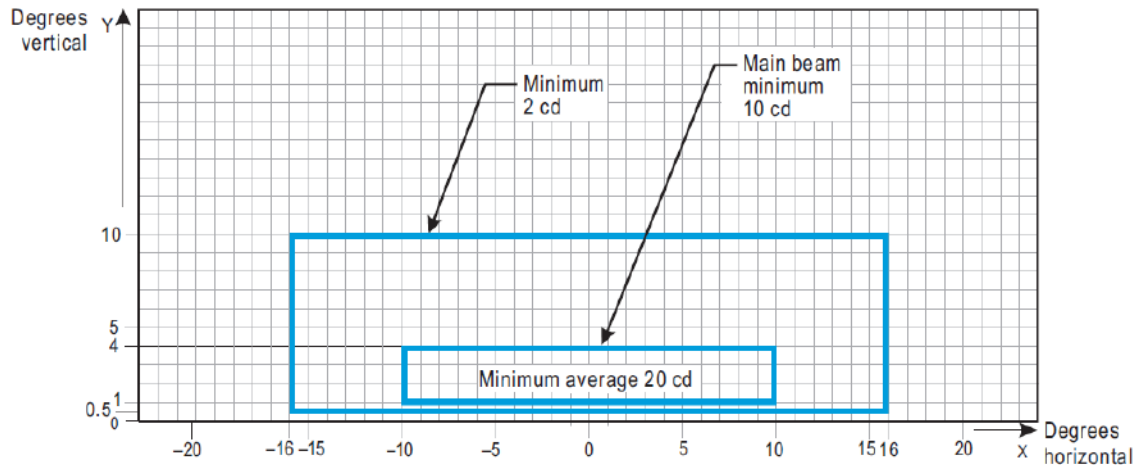
## GACAR PART 139 – CERTIFICATION, AUTHORIZATION AND OPERATION OF AERODROMES



1. Lights on curves to be toed-in 15.75 degrees with respect to the tangent of the curve.
2. See collective notes for Figures AH-17 to AH-26

**Figure AH-19. Isocandela diagram for taxiway centre line (7.5 m spacing), no-entry bar and stop bar lights in curved sections intended for use in runway visual range conditions of less than a value of 350 m**

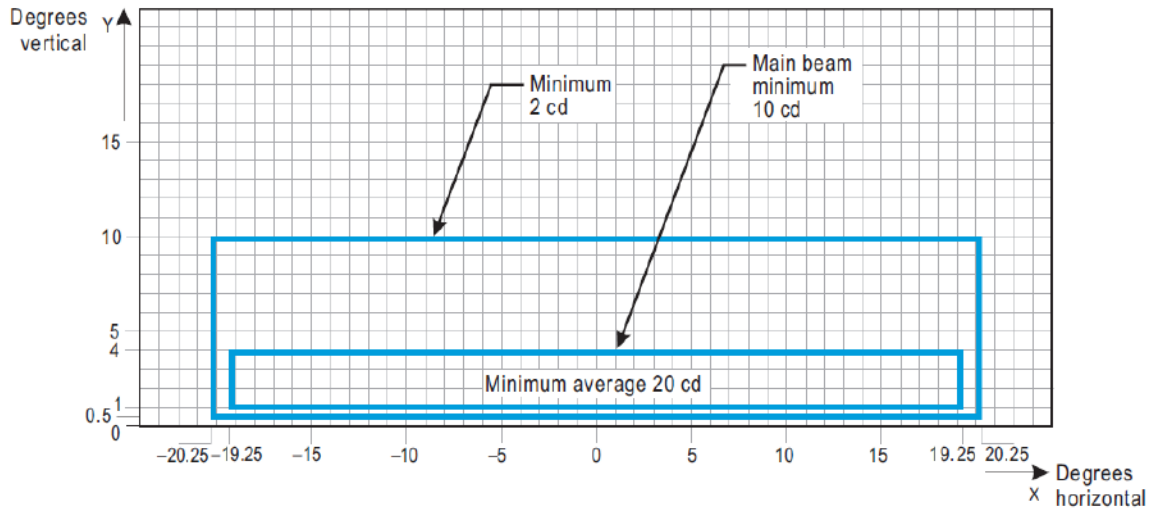
## GACAR PART 139 – CERTIFICATION, AUTHORIZATION AND OPERATION OF AERODROMES



1. At locations where high background luminance is usual and where deterioration of light output resulting from dust, snow and local contamination is a significant factor, the cd-values must be multiplied by 2.5.
2. Where omnidirectional lights are used, they must comply with the vertical beam requirements in this figure.
3. See collective notes for Figures AH-17 to AH-26

**Figure AH-20. Isocandela diagram for taxiway centre line (30 m, 60 m spacing), no-entry bar and stop bar lights in straight sections intended for use in runway visual range conditions of 350 m or greater**

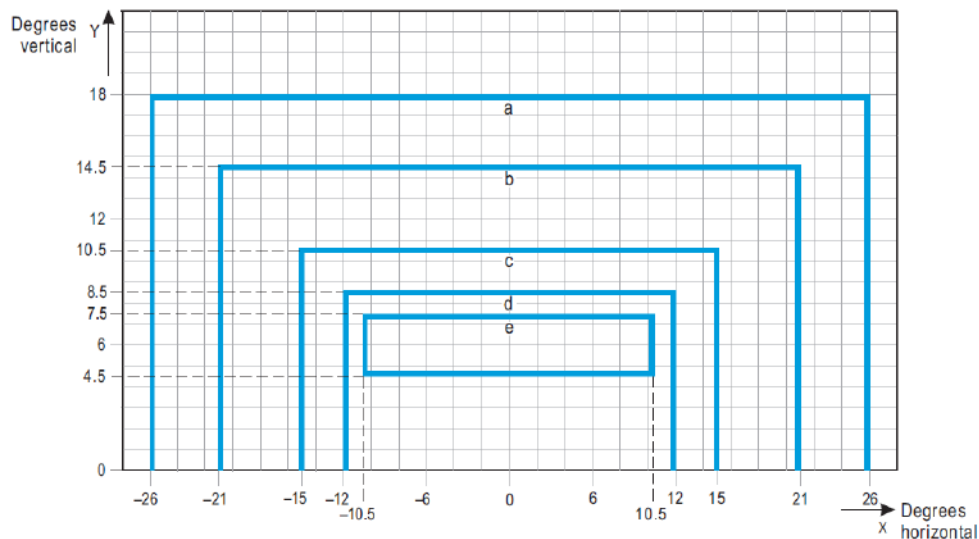
## GACAR PART 139 – CERTIFICATION, AUTHORIZATION AND OPERATION OF AERODROMES



1. Lights on curves to be toed-in 15.75 degrees with respect to the tangent of the curve.
2. At locations where high background luminance is usual and where deterioration of light output resulting from dust, snow and local contamination is a significant factor, the cd-values must be multiplied by 2.5.
3. These beam coverages allow for displacement of the cockpit from the centre line up to distances of the order of 12 m as could occur at the end of curves.
4. See collective notes for Figures AH-17 to AH-26

**Figure AH-21. Isocandela diagram for taxiway centre line (7.5 m, 15 m, 30 m spacing), no-entry bar and stop bar lights in curved sections intended for use in runway visual range conditions of 350 m or greater.**

## GACAR PART 139 – CERTIFICATION, AUTHORIZATION AND OPERATION OF AERODROMES

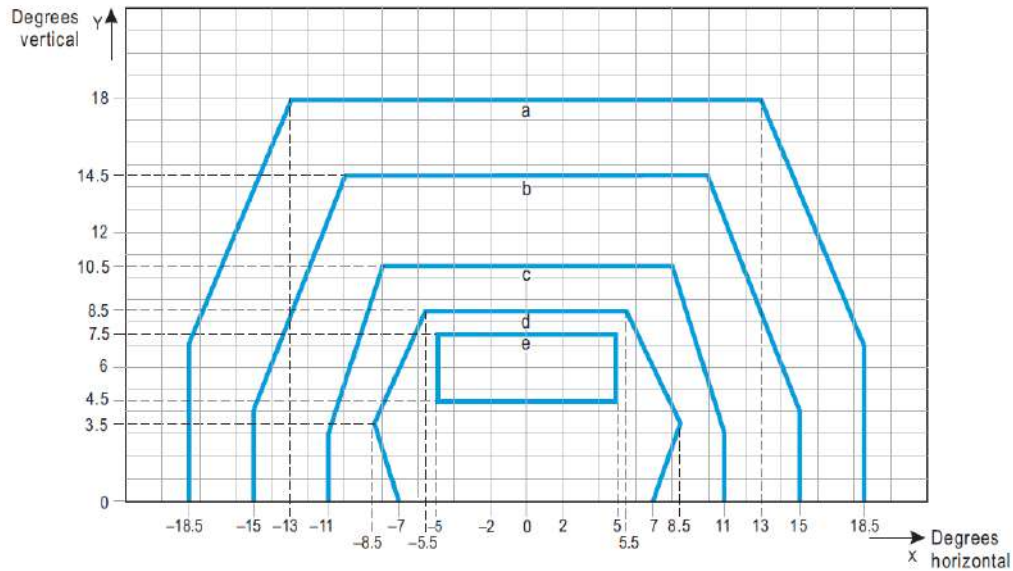


1. Beam coverage allows for displacement of the cockpit from the centre line up of distances in the order of 12 m and is intended for use before and after curves.

2. See collective notes for Figures AH-17 to AH-26

**Figure AH-22. Isocandela diagram for high-intensity taxiway center line (15 m spacing), no-entry bar and stop bar lights in straight sections intended for use in an advanced surface movement guidance and control system where higher light intensities are required and where large offsets can occur.**

## GACAR PART 139 – CERTIFICATION, AUTHORIZATION AND OPERATION OF AERODROMES

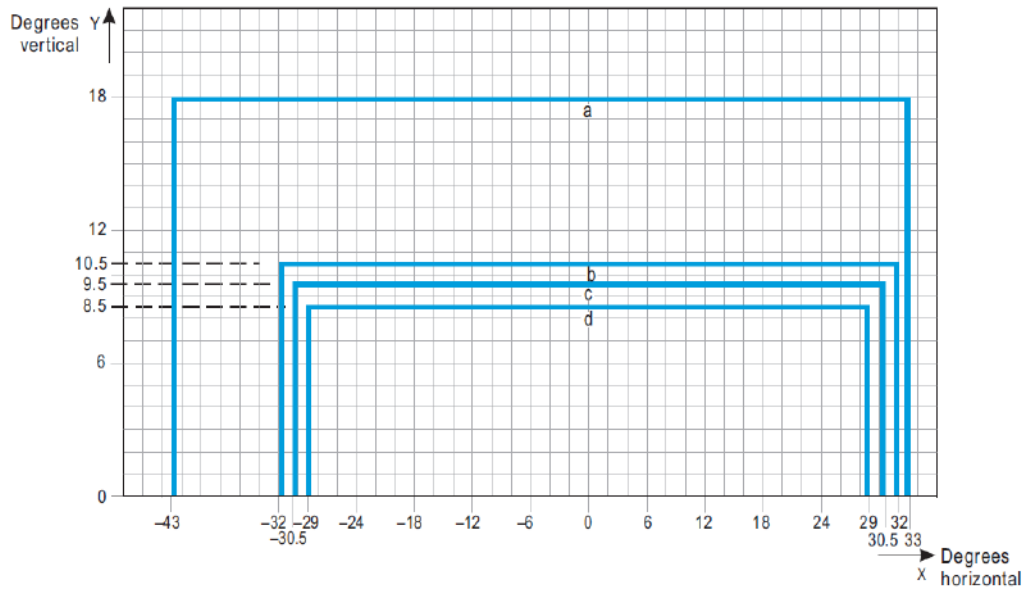


1. Beam coverage is generally satisfactory and caters to a normal displacement of the cockpit corresponding to the outer main gear wheel on the taxiway edge.

2. See collective notes for Figures AH-17 to AH-26.

**Figure AH-23. Isocandela diagram for high-intensity taxiway centre line (15 m spacing), no-entry bar and stop bar lights in straight sections intended for use in an advanced surface movement guidance and control system where higher light intensities are required.**

## GACAR PART 139 – CERTIFICATION, AUTHORIZATION AND OPERATION OF AERODROMES



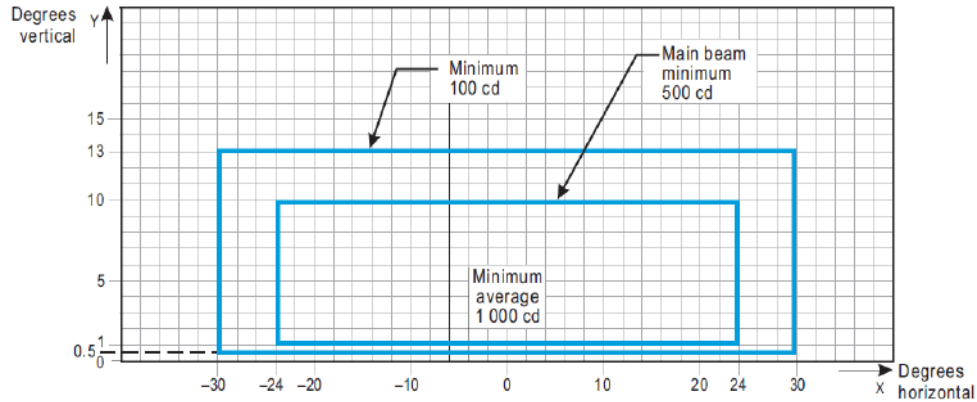
| Curve          | a | b   | c   | d   |
|----------------|---|-----|-----|-----|
| Intensity (cd) | 8 | 100 | 200 | 400 |

1. Lights on curves to be toed-in 17 degrees with respect to the tangent of the curve.
2. See collective notes for Figures AH-17 to AH-26.

**Figure AH-24. Isocandela diagram for high-intensity taxiway centre line (7.5 m spacing), no-entry bar and stop bar lights in curved sections intended for use in an advanced surface movement guidance and control system where higher light intensities are required.**



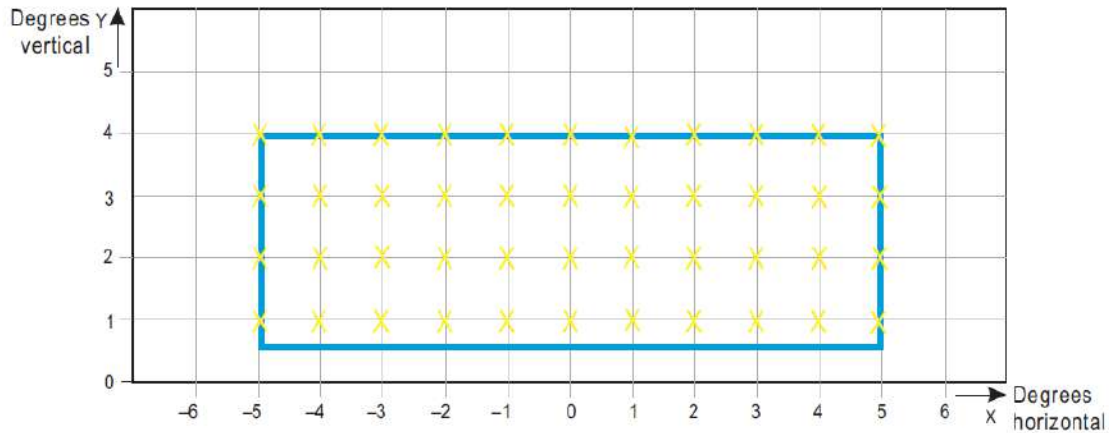
## GACAR PART 139 – CERTIFICATION, AUTHORIZATION AND OPERATION OF AERODROMES



1. Although the lights flash in normal operation, the light intensity is specified as if the lights were fixed for incandescent lamps.
2. See collective notes for Figures AH-17 to AH-26.

**Figure AH-25. Isocandela diagram for high-intensity runway guard lights, Configuration B**

## GACAR PART 139 – CERTIFICATION, AUTHORIZATION AND OPERATION OF AERODROMES



**Figure AH-26. Grid points to be used for calculation of average intensity of taxiway centre line and stop bar light.**

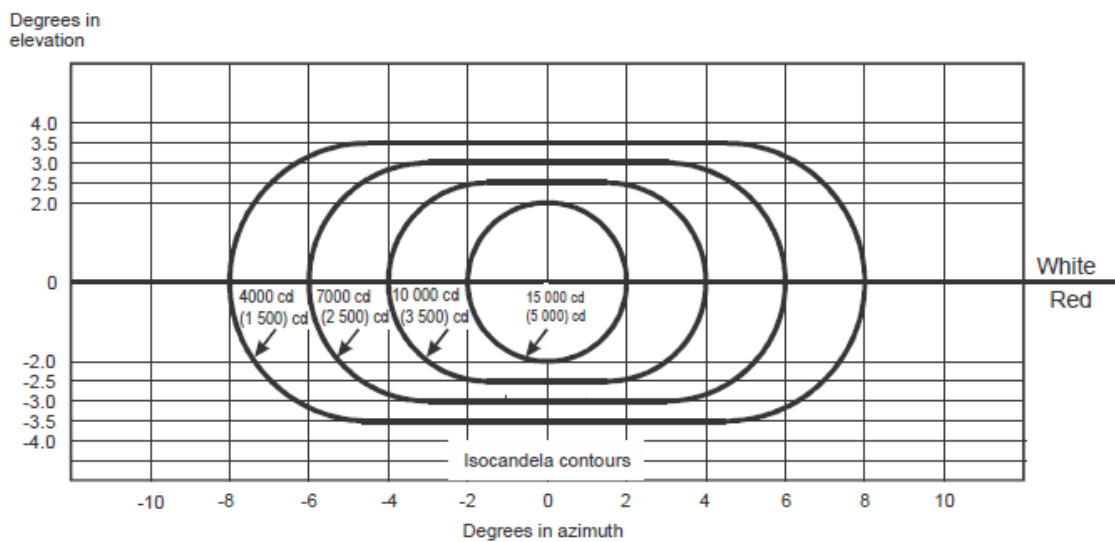
(a) Collective notes to Figures AH-17 to AH-26.

- (1) The intensities specified in Figures AH-17 to AH-25 are in green and yellow light for taxiway center line lights, yellow light for runway guard lights and red light for stop bar lights.
- (2) Figures AH-17 to AH-25 show the minimum allowable light intensities. The average intensity of the main beam is calculated by establishing grid points as shown in Figure AH-26 and using the intensity values measured at all grid points located within and on the perimeter of the rectangle representing the main beam. The average value is the arithmetic average of the light intensities measured at all considered grid points.
- (3) No deviations are acceptable in the main beam or in the innermost beam, as applicable, when the lighting fixture is properly aimed.
- (4) Horizontal angles are measured with respect to the vertical plane through the taxiway center line except on curves where they are measured with respect to the tangent to the curve.
- (5) Vertical angles are measured from the longitudinal slope of the taxiway surface.
- (6) The importance of adequate maintenance cannot be over-emphasized. The intensity, either average where applicable or as specified on the corresponding isocandela curves, must never fall to a value

## GACAR PART 139 – CERTIFICATION, AUTHORIZATION AND OPERATION OF AERODROMES

less than 50 per cent of the value shown in the figures and it must be the aim of airport authorities to maintain a level of light output close to the specified minimum average intensity.

- (7) The light unit must be installed so that the main beam or the innermost beam, as applicable, is aligned within one-half degree of the specified requirement.



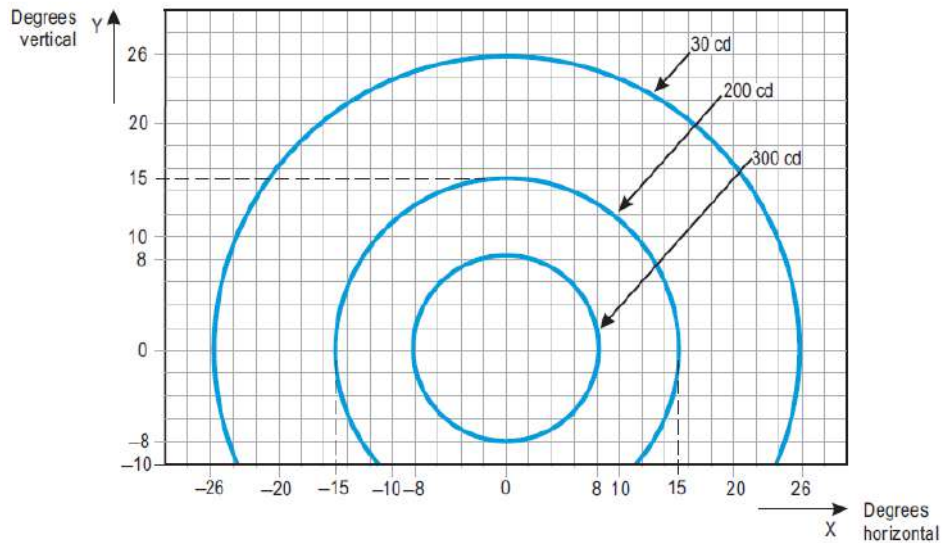
Note 1. These curves are for minimum intensities in red light.

Note 2. The intensity value in the white sector of the beam is no less than 2 and may be as high as 6.5 times the corresponding intensity in the red sector.

Note 3. The intensity values shown in brackets are for APAPI.

**Figure AH-27. Light intensity distribution of PAPI and APAPI**

## GACAR PART 139 – CERTIFICATION, AUTHORIZATION AND OPERATION OF AERODROMES

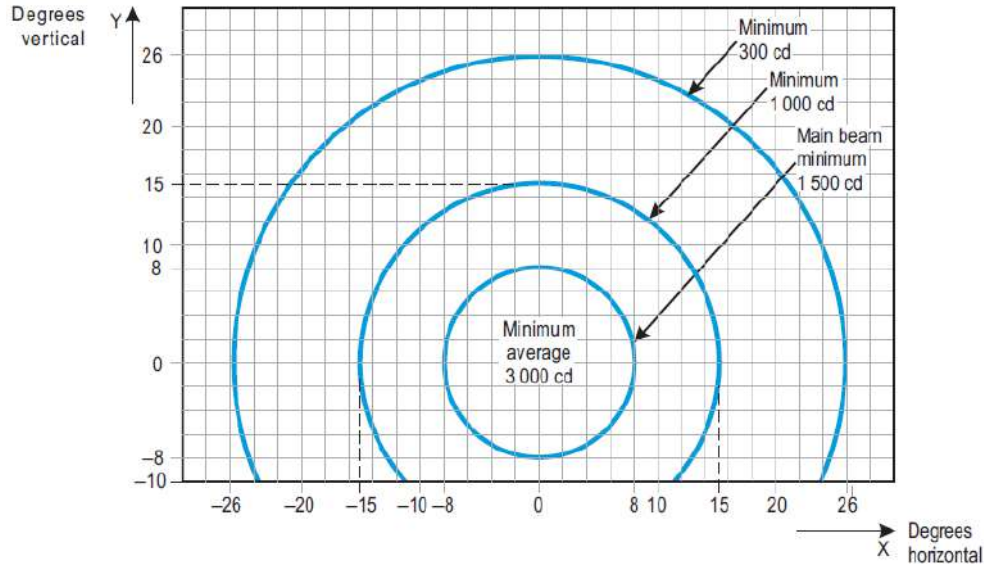


1. Although the lights flash in normal operation, the light intensity is specified as if the lights were fixed or incandescent lamps.

2. The intensities specified are in yellow light.

**Figure AH-28. Isocandela diagram for each light in high-intensity runway guard lights, Configuration A**

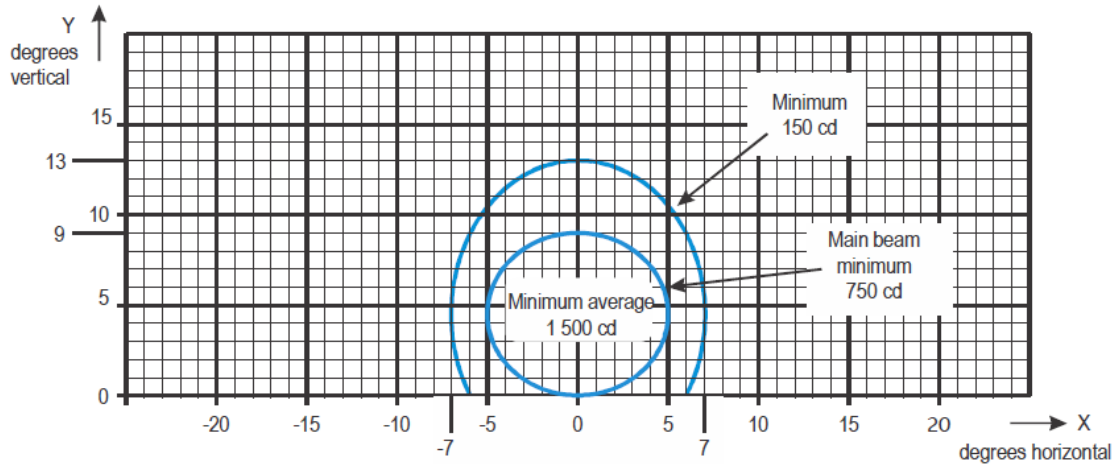
## GACAR PART 139 – CERTIFICATION, AUTHORIZATION AND OPERATION OF AERODROMES



1. Although the lights flash in normal operation, the light intensity is specified as if the lights were fixed for incandescent lamps.
2. The intensities specified are in yellow light

**Figure AH-29. Isocandela diagram for each light in high-intensity runway guard lights, Configuration A**

## GACAR PART 139 – CERTIFICATION, AUTHORIZATION AND OPERATION OF AERODROMES



Notes:

1. Curves calculated on formula

$$\frac{x^2}{a^2} + \frac{y^2}{b^2} = 1$$

|   |     |     |
|---|-----|-----|
| a | 5.0 | 7.0 |
| b | 4.5 | 8.5 |

2. See collective notes for Figures AE-6 to AE-16 and AE-30

**Figure AH-30. Isocandela diagram for take-off and hold lights (THL) (red light)**

### V. MANDATORY INSTRUCTION MARKINGS AND INFORMATION MARKINGS

Note 1. See Subpart H, Sections § 139.503-(p) and § 139.503-(q) for specifications on the application, location and characteristics of mandatory instruction markings and information markings.

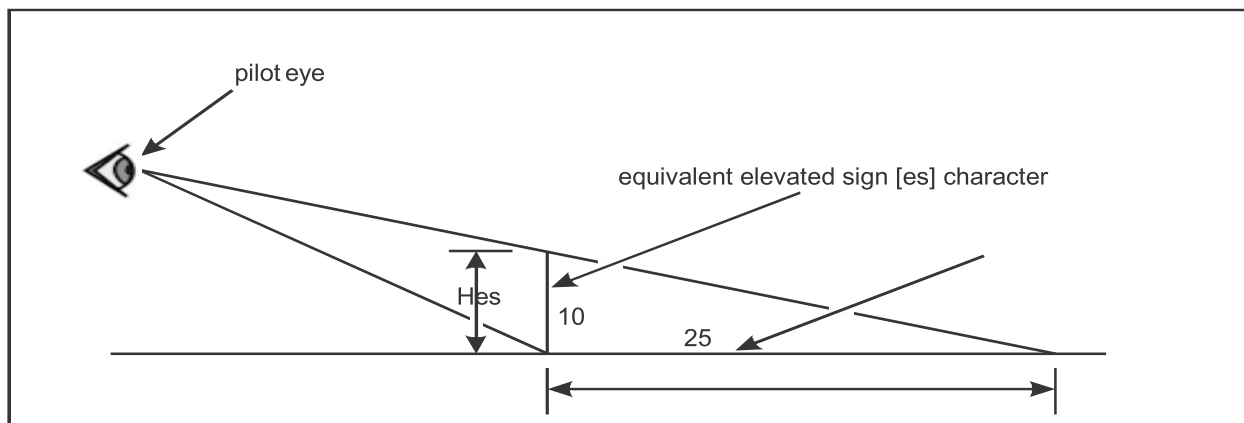
Note 2. This appendix details the form and proportions of the letters, numbers and symbols of mandatory instruction markings and information markings on a 20 cm grid.

Note 3. The mandatory instruction markings and information markings on pavements are formed as if shadowed (i.e., stretched) from the characters of an equivalent elevated sign by a factor of 2.5 as shown in Figure AH-31. The shadowing, however, only affects the vertical dimension.

## GACAR PART 139 – CERTIFICATION, AUTHORIZATION AND OPERATION OF AERODROMES

Therefore, the spacing of characters for pavement marking is obtained by first determining the equivalent elevated sign character height and then proportioning from the spacing values given in Table H-1.

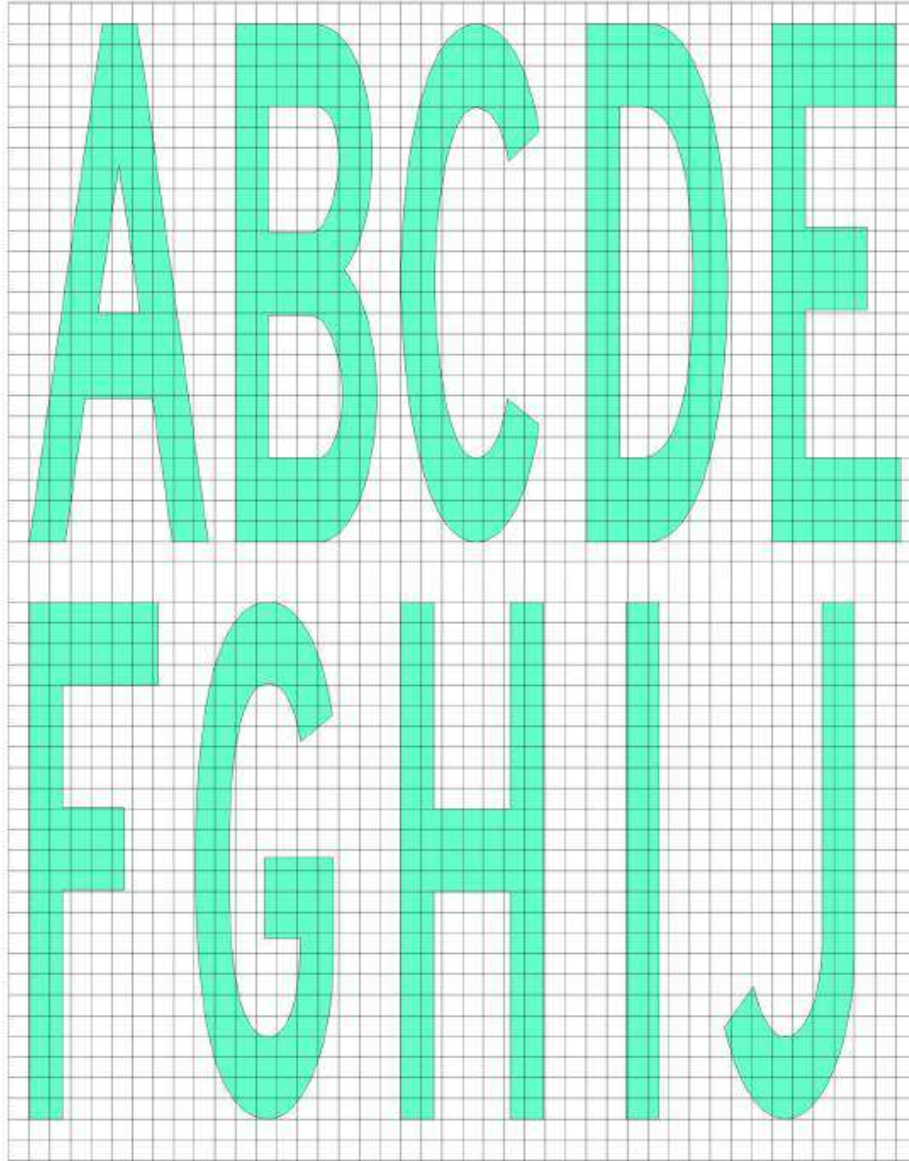
For example, in the case of the runway designator “10” which is to have a height of 4 000 mm (Hps), the equivalent elevated sign character height is  $4\,000/2.5=1\,600$  mm (Hes). Table H-1(b) indicates numeral to numeral code 1 and from Table H-1(c) this code has a dimension of 96 mm, for a character height of 400 mm. The pavement marking spacing for “10” is then  $(1\,600/400)*96=384$  mm.



**Figure AH-31**

**GACAR PART 139 – CERTIFICATION, AUTHORIZATION AND OPERATION OF  
AERODROMES**

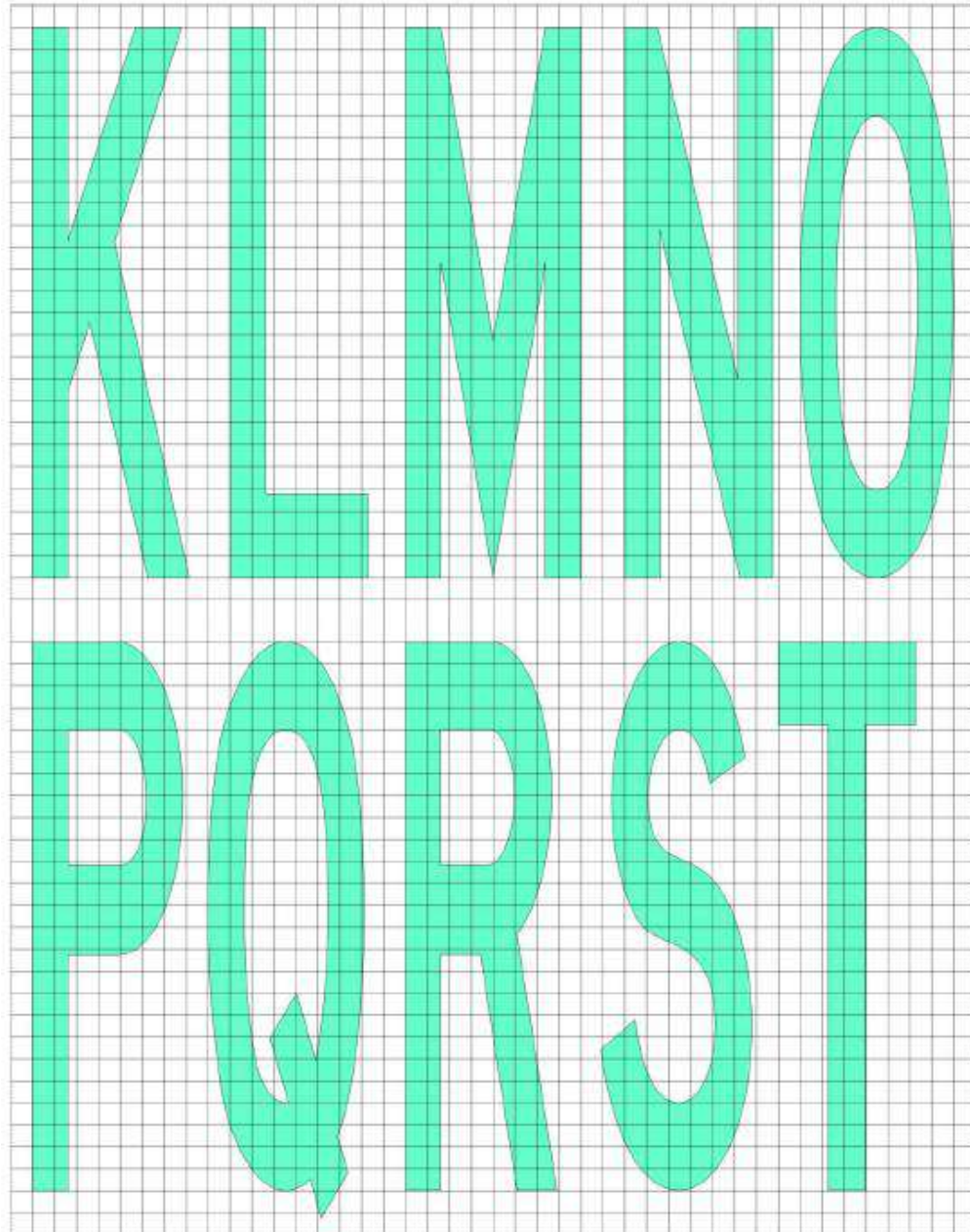
---





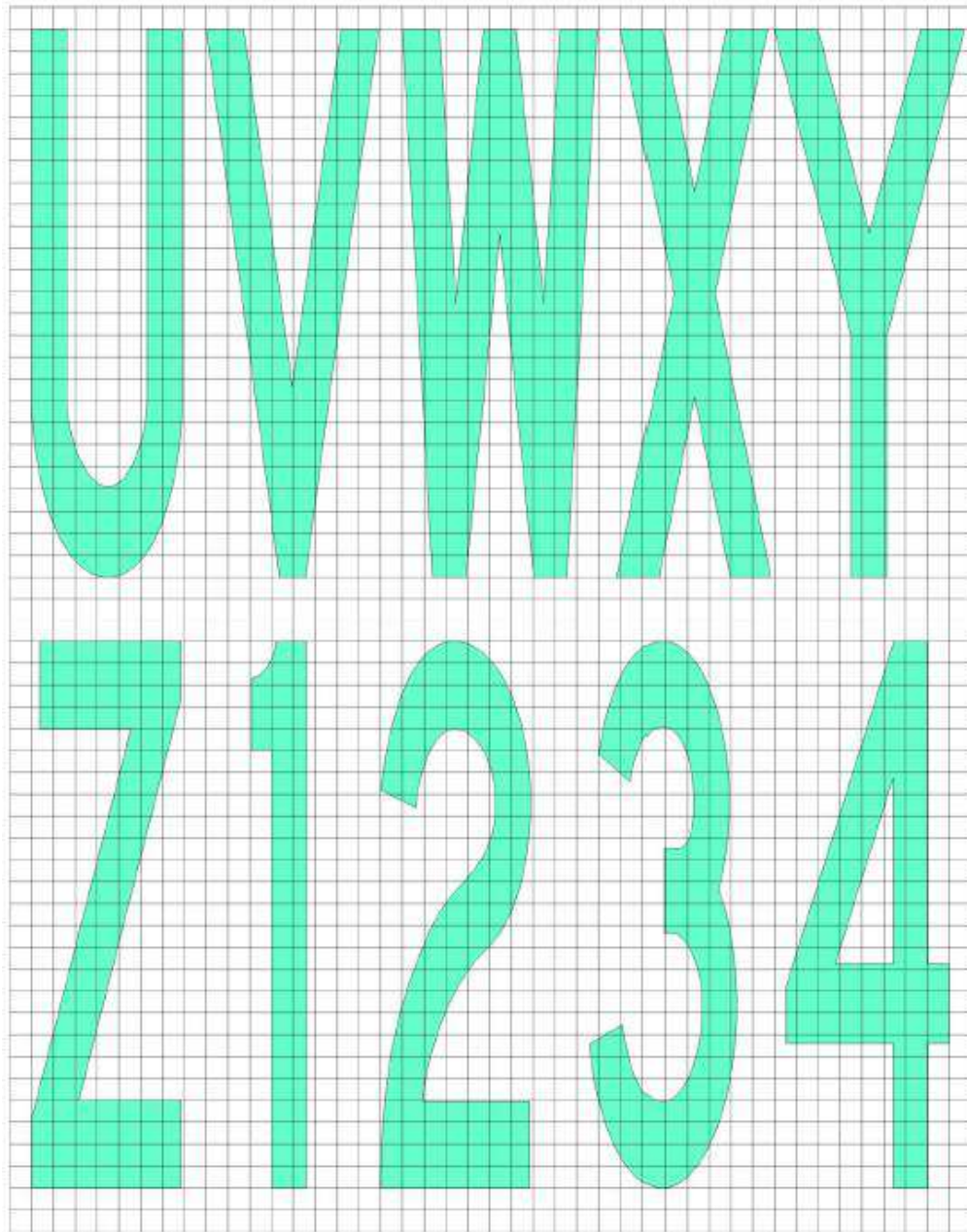
**GACAR PART 139 – CERTIFICATION, AUTHORIZATION AND OPERATION OF  
AERODROMES**

---



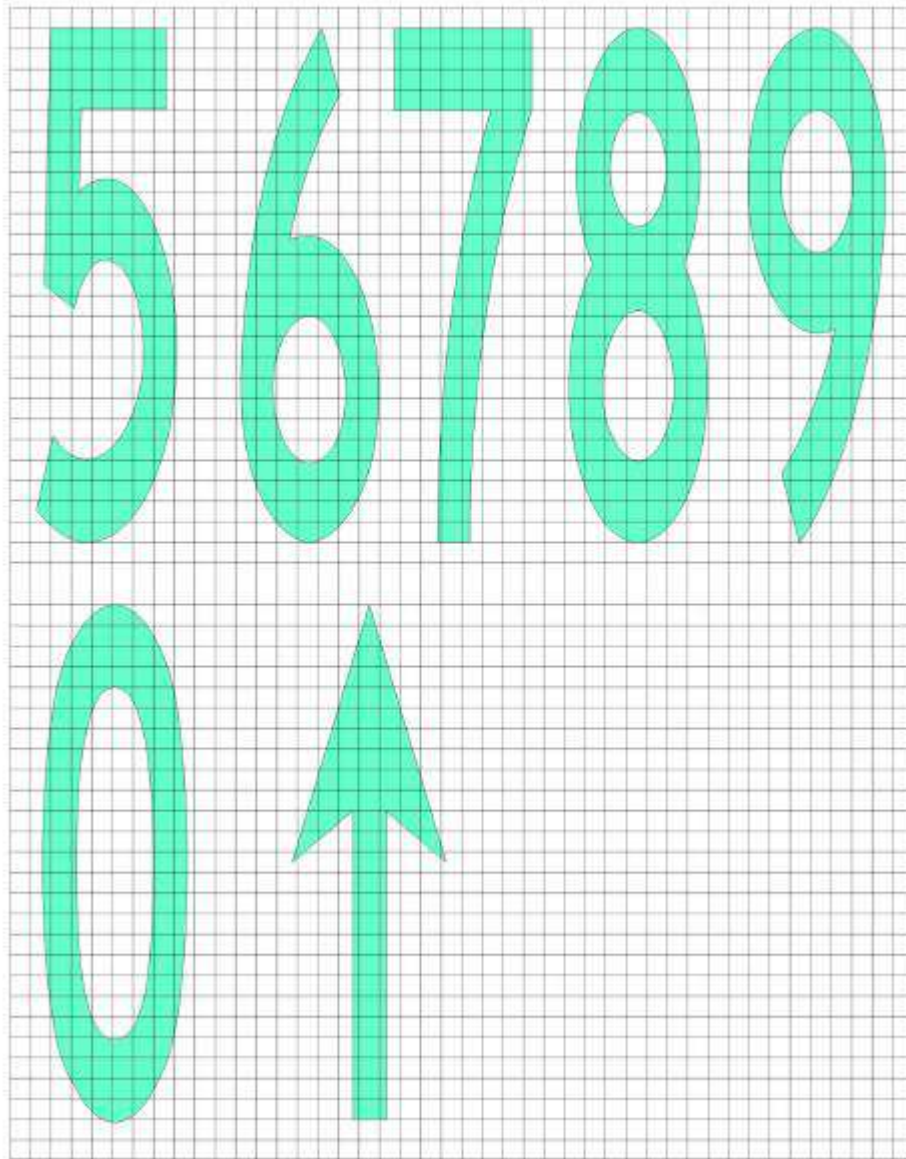
**GACAR PART 139 – CERTIFICATION, AUTHORIZATION AND OPERATION OF  
AERODROMES**

---



**GACAR PART 139 – CERTIFICATION, AUTHORIZATION AND OPERATION OF  
AERODROMES**

---



## GACAR PART 139 – CERTIFICATION, AUTHORIZATION AND OPERATION OF AERODROMES

### VI. REQUIRMENT CONCERNING DESIGN OF TAXIING GUIDANCE SIGNS

*Note. See Chapter I, Section § 139.507 for specifications on the application, location and characteristics of signs.*

(a) Inscription heights must conform to the following tabulation:

| Runway Code number | Minimum character height   |                                       |             |
|--------------------|----------------------------|---------------------------------------|-------------|
|                    | Mandatory instruction sign | Information sign                      |             |
|                    |                            | Runway exit and runway vacation signs | Other signs |
| 1 or 2             | 300 mm                     | 300 mm                                | 200 mm      |
| 3 or 4             | 400 mm                     | 400 mm                                | 300 mm      |

*Note. Where a taxiway location sign is installed in conjunction with a runway designation sign (see § 139.507-(c)-(2)-(ix)), the character size must be that specified for mandatory instruction signs.*

(b) Arrow dimensions must be as follows:

| Legend height | Stroke |
|---------------|--------|
| 200 mm        | 32 mm  |
| 300 mm        | 48 mm  |
| 400 mm        | 64 mm  |

(c) Stroke width for single letter must be as follows:

| Legend height | Stroke |
|---------------|--------|
| 200 mm        | 32 mm  |
| 300 mm        | 48 mm  |



## GACAR PART 139 – CERTIFICATION, AUTHORIZATION AND OPERATION OF AERODROMES

(j) The face height of signs must be as follows:

| Legend height | Face height (min) |
|---------------|-------------------|
| 200 mm        | 300 mm            |
| 300 mm        | 450 mm            |
| 400 mm        | 600 mm            |

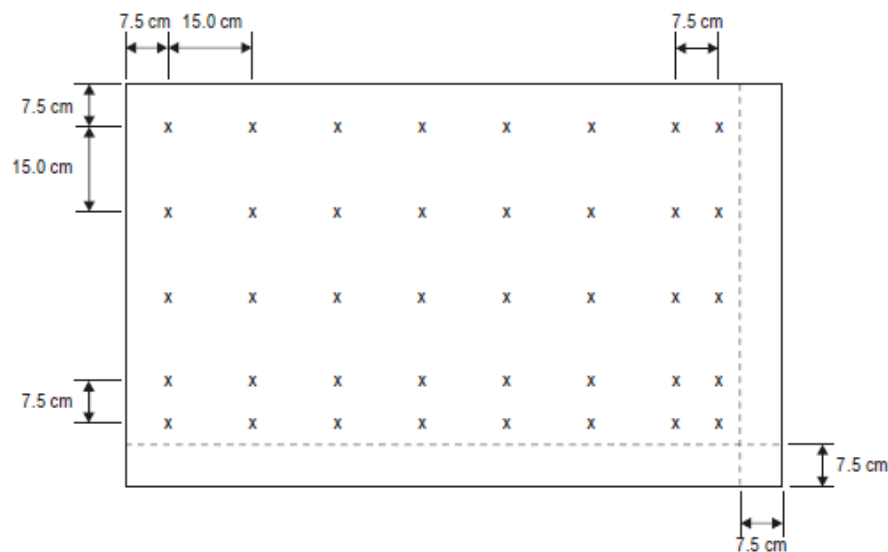
(k) The face width of signs must be determined using Figure AH-34 except that, where a mandatory instruction sign is provided on one side of a taxiway only, the face width must not be less than:

- (1) 1.94 m where the code number is 3 or 4; and
- (2) 1.46 m where the code number is 1 or 2.

(l) Borders

- a) The black vertical delineator between adjacent direction signs must have a width of approximately 0.7 of the strokes width
- b) The yellow border on a stand-alone location sign must be approximately 0.5 stroke width.

(m) The colors of signs must be in accordance with the appropriate specifications in Appendix H.



## **GACAR PART 139 – CERTIFICATION, AUTHORIZATION AND OPERATION OF AERODROMES**

---

*Note 1. The average luminance of a sign is calculated by establishing grid points on a sign face showing typical inscriptions and a background of the appropriate color (red for mandatory instruction signs and yellow for direction and destination signs) as follows:*

- a. Starting at the top left corner of the sign face, establish a reference grid point at 7.5 cm from the left edge and the top of the sign face.*
- b. Create a grid of 15 cm spacing horizontally and vertically from the reference grid point. Grid points within 7.5 cm of the edge of the sign face must be excluded.*
- c. Where the last point in a row/column of grid points is located between 22.5 cm and 15 cm from the edge of the sign face (but not inclusive), an additional point must be added 7.5 cm from this point.*
- d. Where a grid point falls on the boundary of a character and the background, the grid point must be slightly shifted to be completely outside the character.*

*Note 2. Additional grid points may be required to ensure that each character includes at least five evenly spaced grid points.*

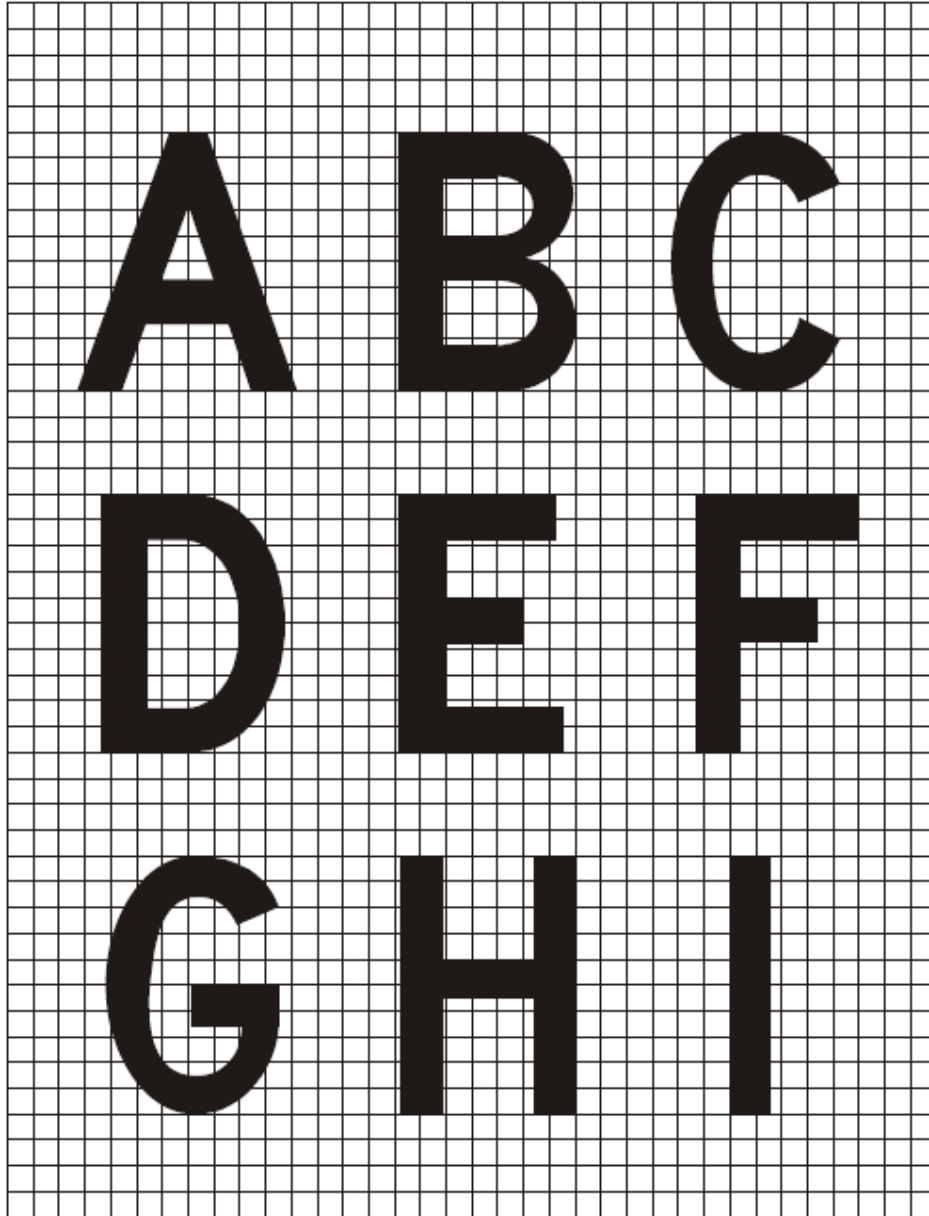
*Note 3. Where one unit includes two types of signs, a separate grid must be established for each type.*

---

### **Figure AH-32. Grid points for calculating average luminance of a sign.**

**GACAR PART 139 – CERTIFICATION, AUTHORIZATION AND OPERATION OF  
AERODROMES**

---

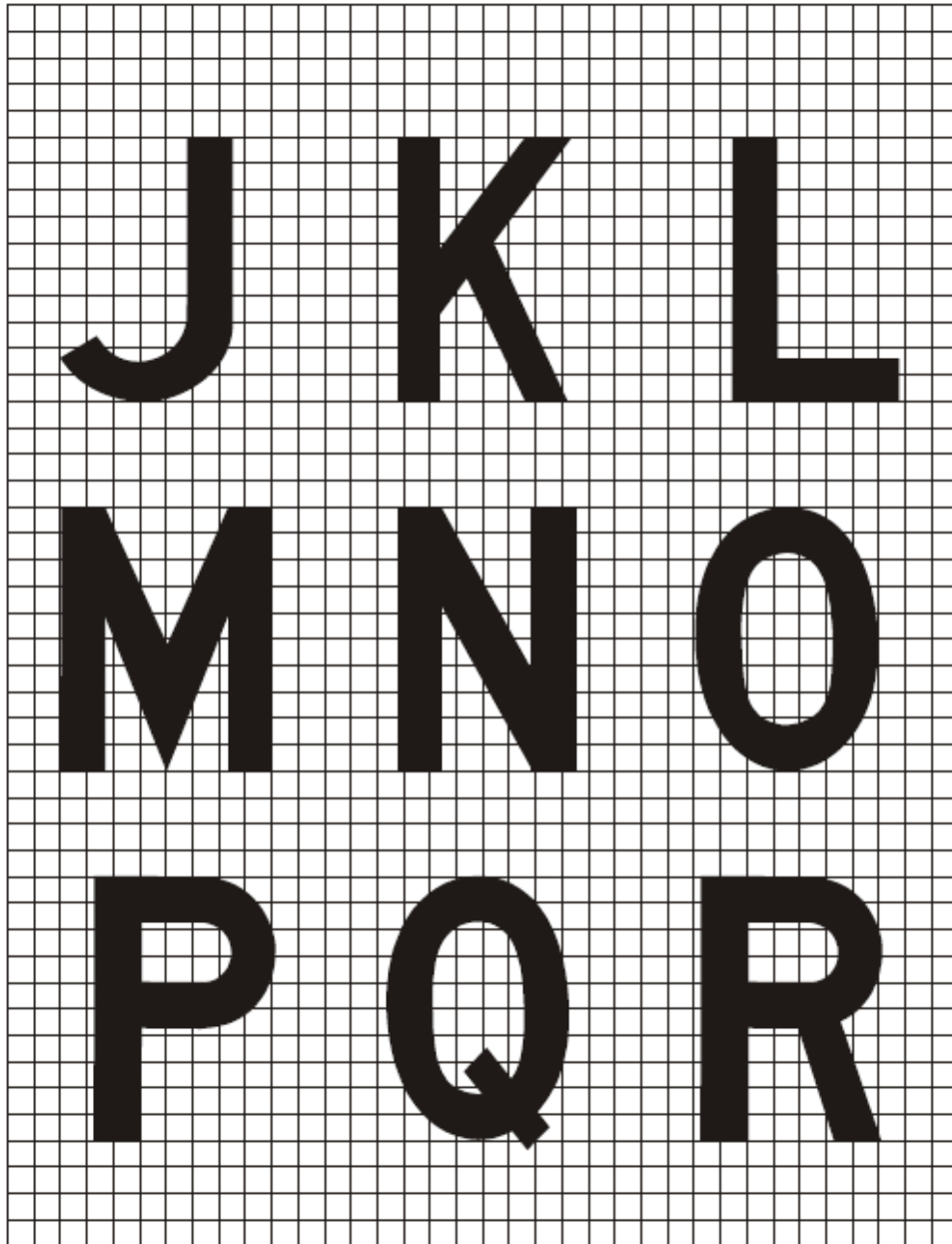


**Figure AH-33 Forms of Character**



**GACAR PART 139 – CERTIFICATION, AUTHORIZATION AND OPERATION OF  
AERODROMES**

---

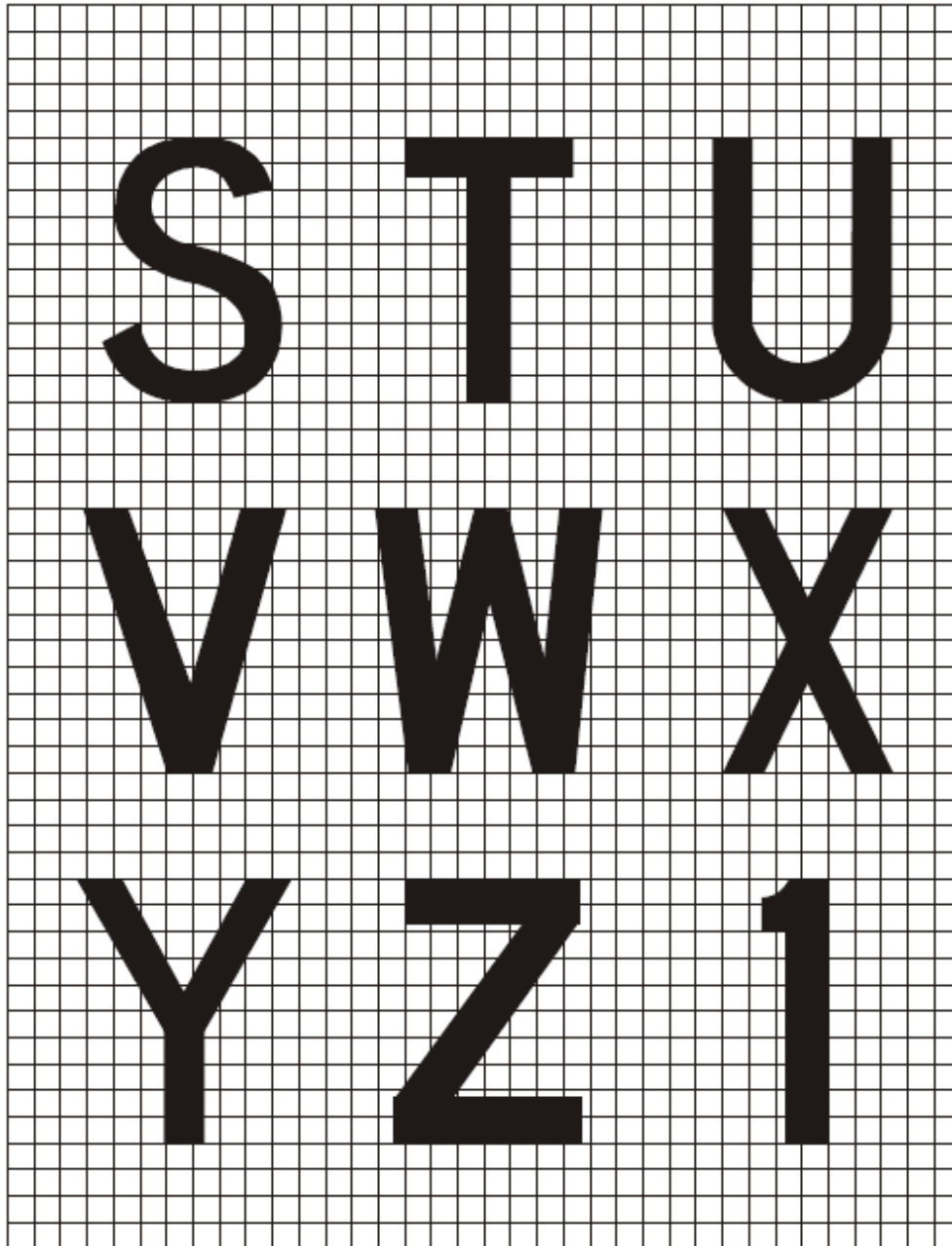


**Figure AH-33 (Contd.)**

---

**GACAR PART 139 – CERTIFICATION, AUTHORIZATION AND OPERATION OF  
AERODROMES**

---

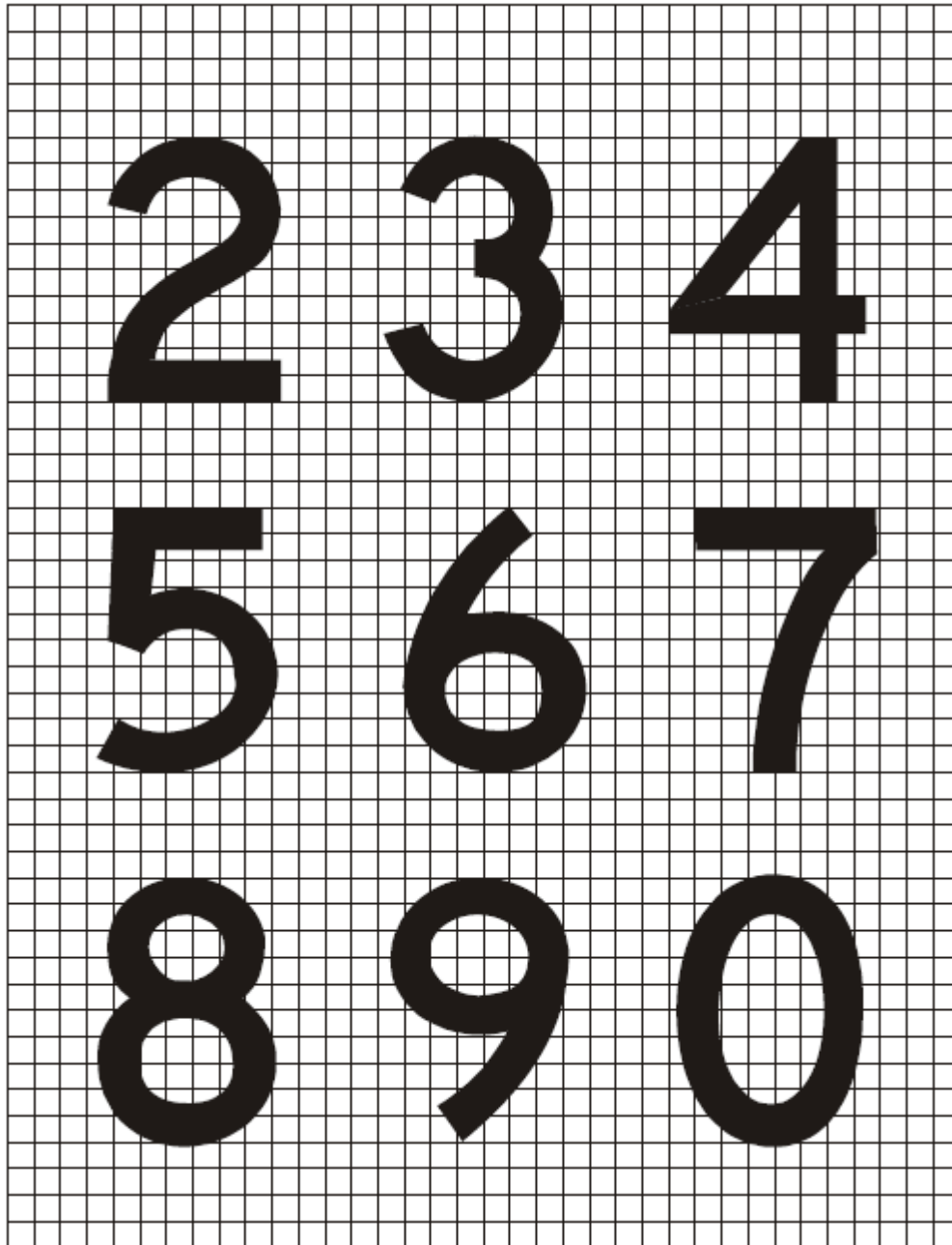


**Figure AH-33 (Contd.)**

---

**GACAR PART 139 – CERTIFICATION, AUTHORIZATION AND OPERATION OF  
AERODROMES**

---

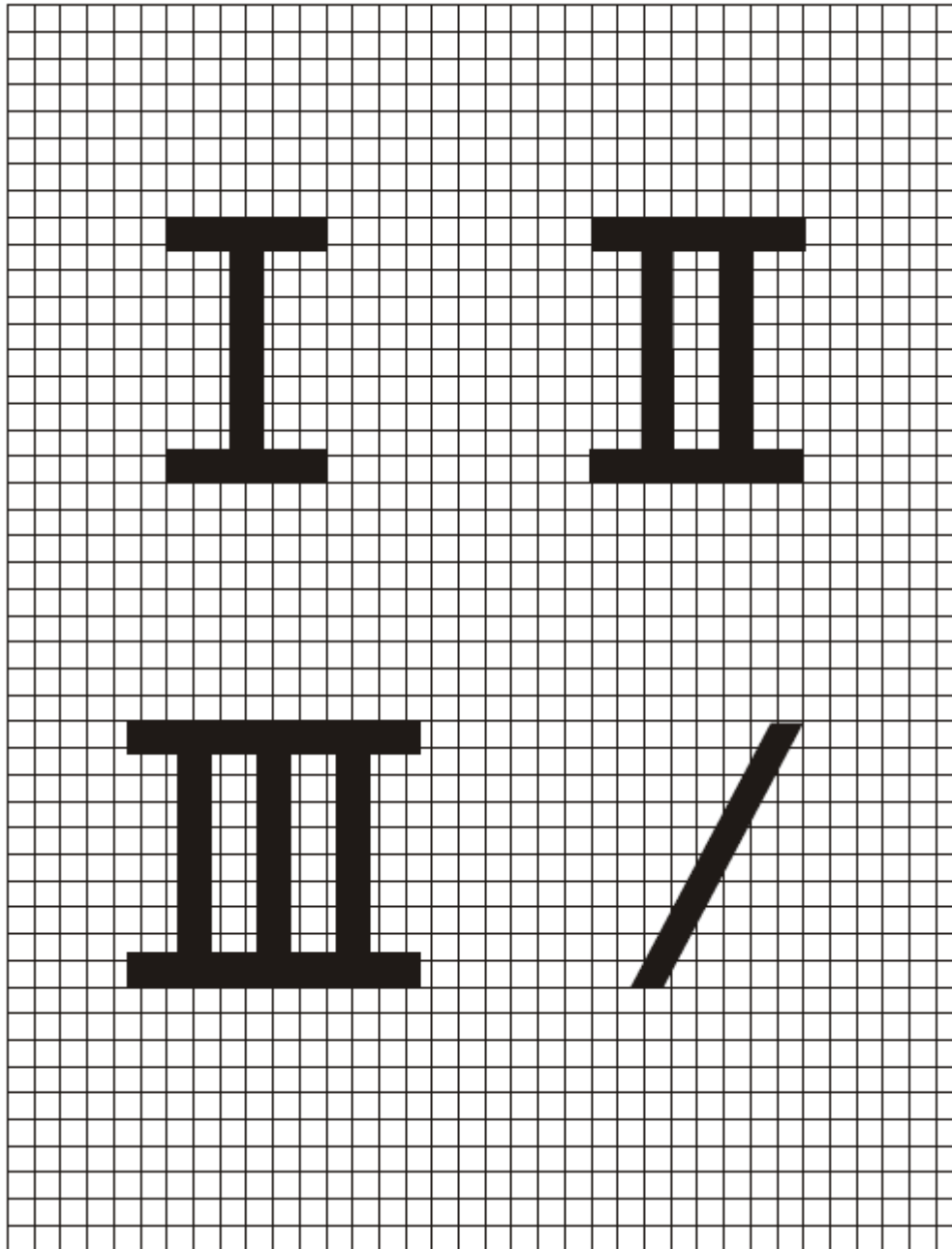


**Figure AH-33 (Contd.)**

---

**GACAR PART 139 – CERTIFICATION, AUTHORIZATION AND OPERATION OF  
AERODROMES**

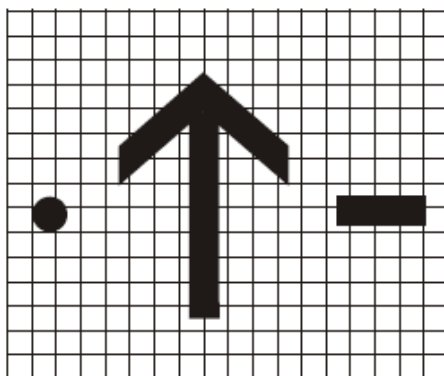
---



**Figure AH-33 (Contd.)**

**GACAR PART 139 – CERTIFICATION, AUTHORIZATION AND OPERATION OF  
AERODROMES**

---

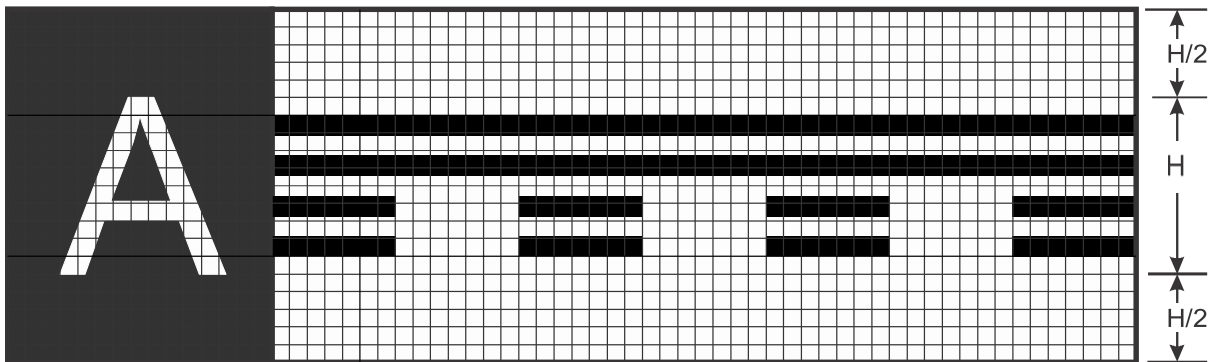


Note 1. The arrow stroke width, diameter of the dot, and both width and length of the dash must be proportioned to the character stroke width.

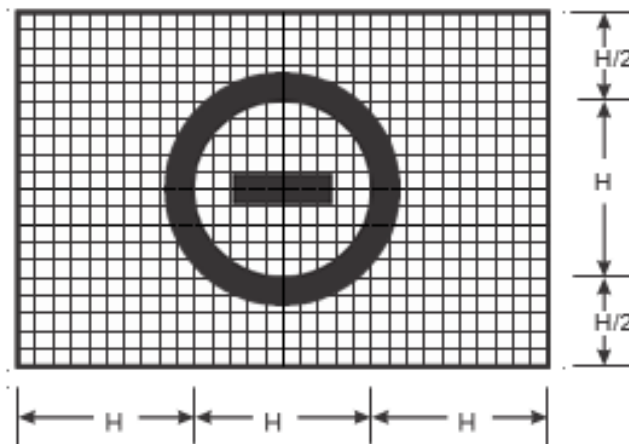
Note 2. The dimensions of the arrow must remain constant for particular sign size, regardless of orientation.

**Figure AH-33.**

## GACAR PART 139 – CERTIFICATION, AUTHORIZATION AND OPERATION OF AERODROMES



**RUNWAY VACATED SIGN**



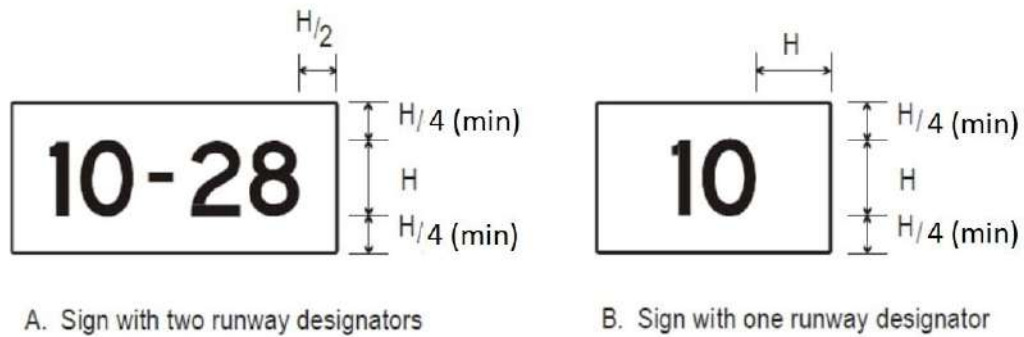
**NO ENTRY SIGN**

**Figure AH-34**

---

**GACAR PART 139 – CERTIFICATION, AUTHORIZATION AND OPERATION OF  
AERODROMES**

---



**Figure AH-35. Sign dimension**

## GACAR PART 139 – CERTIFICATION, AUTHORIZATION AND OPERATION OF AERODROMES

| a) Letter to letter code number |   |                        |                     |
|---------------------------------|---|------------------------|---------------------|
| Preceding Letter                | Following Letter                            |                        |                     |
|                                 | B, D, E, F,<br>H, I, K, L,<br>M, N, P, R, U | C, G, O,<br>Q, S, X, Z | A, J, T,<br>V, W, Y |
|                                 | Code number                                 |                        |                     |
| A                               | 2   | 2                      | 4                   |
| B                               | 1   | 2                      | 2                   |
| C                               | 2   | 2                      | 3                   |
| D                               | 1   | 2                      | 2                   |
| E                               | 2   | 2                      | 3                   |
| F                               | 2   | 2                      | 3                   |
| G                               | 1   | 2                      | 2                   |
| H                               | 1   | 1                      | 2                   |
| I                               | 1   | 1                      | 2                   |
| J                               | 1   | 1                      | 2                   |
| K                               | 2   | 2                      | 3                   |
| L                               | 2   | 2                      | 4                   |
| M                               | 1   | 1                      | 2                   |
| N                               | 1   | 1                      | 2                   |
| O                               | 1   | 2                      | 2                   |
| P                               | 1   | 2                      | 2                   |
| Q                               | 1   | 2                      | 2                   |
| R                               | 1   | 2                      | 2                   |
| S                               | 1   | 2                      | 2                   |
| T                               | 2   | 2                      | 4                   |
| U                               | 1   | 1                      | 2                   |
| V                               | 2   | 2                      | 4                   |
| W                               | 2   | 2                      | 4                   |
| X                               | 2   | 2                      | 3                   |
| Y                               | 2   | 2                      | 4                   |
| Z                               | 2   | 2                      | 3                   |

| b) Numeral to numeral code number |                  |                     |      |
|-----------------------------------|------------------|---------------------|------|
| Preceding Numeral                 | Following number |                     |      |
|                                   | 1, 5             | 2, 3, 6,<br>8, 9, 0 | 4, 7 |
|                                   | Code number      |                     |      |
| 1                                 | 1                | 1                   | 2    |
| 2                                 | 1                | 2                   | 2    |
| 3                                 | 1                | 2                   | 2    |
| 4                                 | 2                | 2                   | 4    |
| 5                                 | 1                | 2                   | 2    |
| 6                                 | 1                | 2                   | 2    |
| 7                                 | 2                | 2                   | 4    |
| 8                                 | 1                | 2                   | 2    |
| 9                                 | 1                | 2                   | 2    |
| 0                                 | 1                | 2                   | 2    |

| c) Space between characters |                    |     |     |
|-----------------------------|--------------------|-----|-----|
| Code No.                    | Letter height (mm) |     |     |
|                             | 200                | 300 | 400 |
|                             | Space (mm)         |     |     |
| 1                           | 48                 | 71  | 96  |
| 2                           | 38                 | 57  | 76  |
| 3                           | 25                 | 38  | 50  |
| 4                           | 13                 | 19  | 26  |

| d) Width of letter |                    |     |     |
|--------------------|--------------------|-----|-----|
| Letter             | Letter height (mm) |     |     |
|                    | 200                | 300 | 400 |
|                    | Width (mm)         |     |     |
| A                  | 170                | 255 | 340 |
| B                  | 137                | 205 | 274 |
| C                  | 137                | 205 | 274 |
| D                  | 137                | 205 | 274 |
| E                  | 124                | 186 | 248 |
| F                  | 124                | 186 | 248 |
| G                  | 137                | 205 | 274 |
| H                  | 137                | 205 | 274 |
| I                  | 32                 | 48  | 64  |
| J                  | 127                | 190 | 254 |
| K                  | 140                | 210 | 280 |
| L                  | 124                | 186 | 248 |
| M                  | 157                | 236 | 314 |
| N                  | 137                | 205 | 274 |
| O                  | 143                | 214 | 286 |
| P                  | 137                | 205 | 274 |
| Q                  | 143                | 214 | 286 |
| R                  | 137                | 205 | 274 |
| S                  | 137                | 205 | 274 |
| T                  | 124                | 186 | 248 |
| U                  | 137                | 205 | 274 |
| V                  | 152                | 229 | 304 |
| W                  | 178                | 267 | 356 |
| X                  | 137                | 205 | 274 |
| Y                  | 171                | 257 | 342 |
| Z                  | 137                | 205 | 274 |

| e) Width of numeral |                     |     |     |
|---------------------|---------------------|-----|-----|
| Numeral             | Numeral height (mm) |     |     |
|                     | 200                 | 300 | 400 |
|                     | Width (mm)          |     |     |
| 1                   | 50                  | 74  | 98  |
| 2                   | 137                 | 205 | 274 |
| 3                   | 137                 | 205 | 274 |
| 4                   | 149                 | 224 | 298 |
| 5                   | 137                 | 205 | 274 |
| 6                   | 137                 | 205 | 274 |
| 7                   | 137                 | 205 | 274 |
| 8                   | 137                 | 205 | 274 |
| 9                   | 137                 | 205 | 274 |
| 0                   | 143                 | 214 | 286 |

**INSTRUCTIONS**

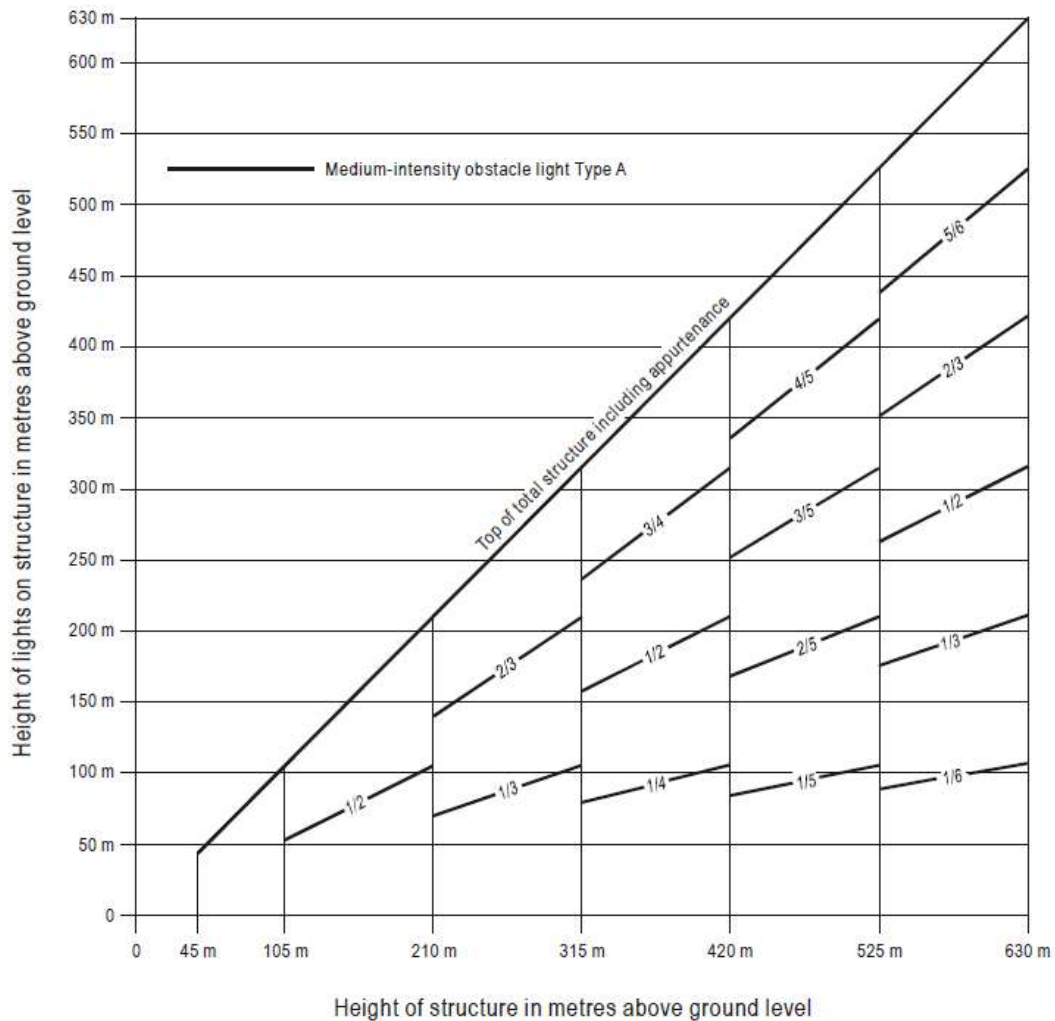
1. To determine the proper SPACE between letters or numerals, obtain the code number from table a) or b) and enter table c) for that code number to the desired letter or numeral height.
2. The space between words or groups of characters forming an abbreviation or symbol should be equal to 0.5 to 0.75 of the height of the characters used except that where an arrow is located with a single character such as 'A →', the space may be reduced to not less than one quarter of the height of the character in order to provide a good visual balance.
3. Where the numeral follows a letter or vice versa use Code 1.
4. Where a hyphen, dot, or diagonal stroke follows a character or vice versa use Code 1.

**Table AH-1. Letter and numeral widths and space between letters or numerals**



## GACAR PART 139 – CERTIFICATION, AUTHORIZATION AND OPERATION OF AERODROMES

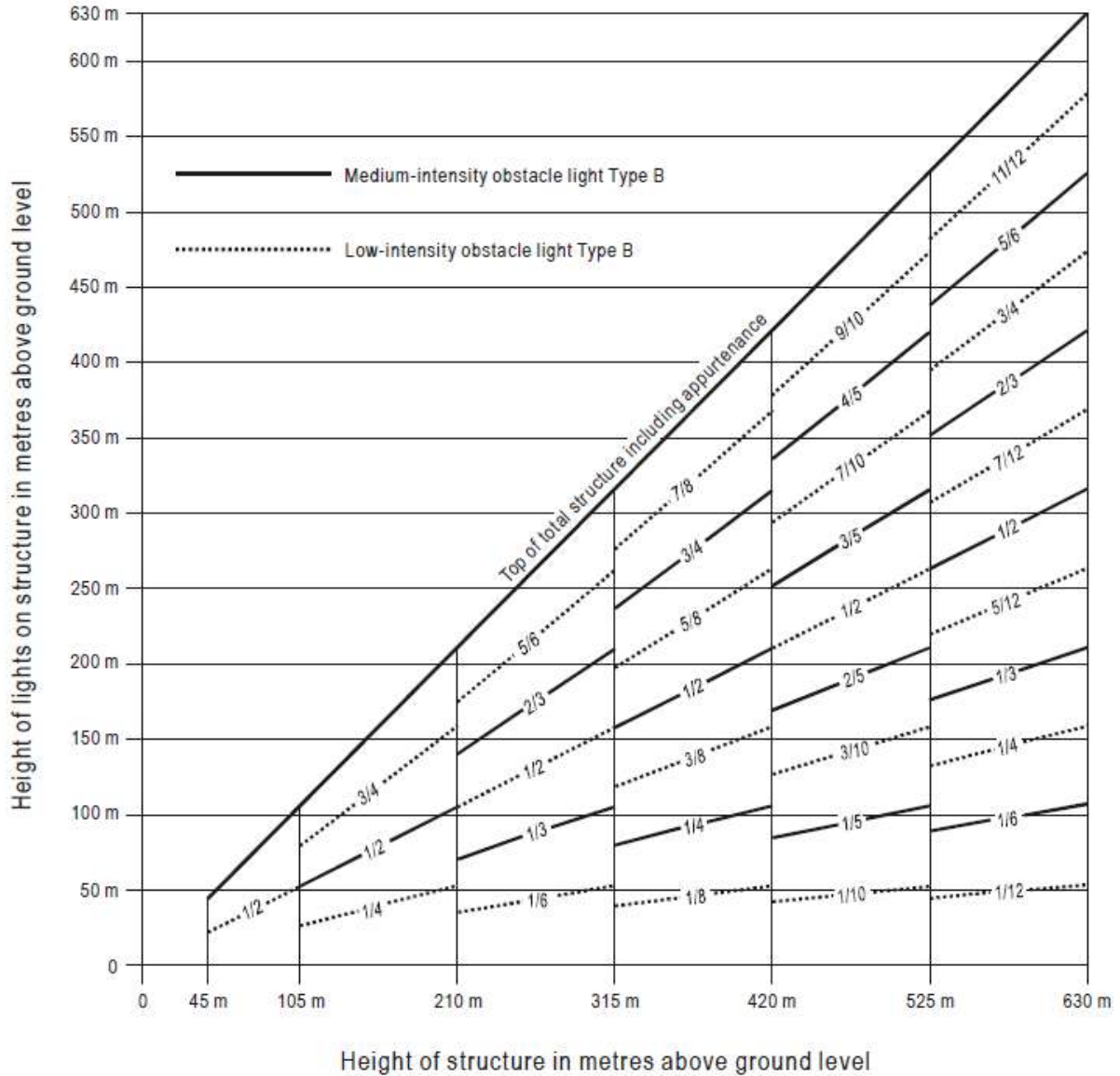
### APPENDIX I - LOCATION OF LIGHTS ON OBSTACLES



Note. High-intensity obstacle lighting is recommended on structures with a height of more than 150 m above ground level. If medium-intensity lighting is used, marking will also be required

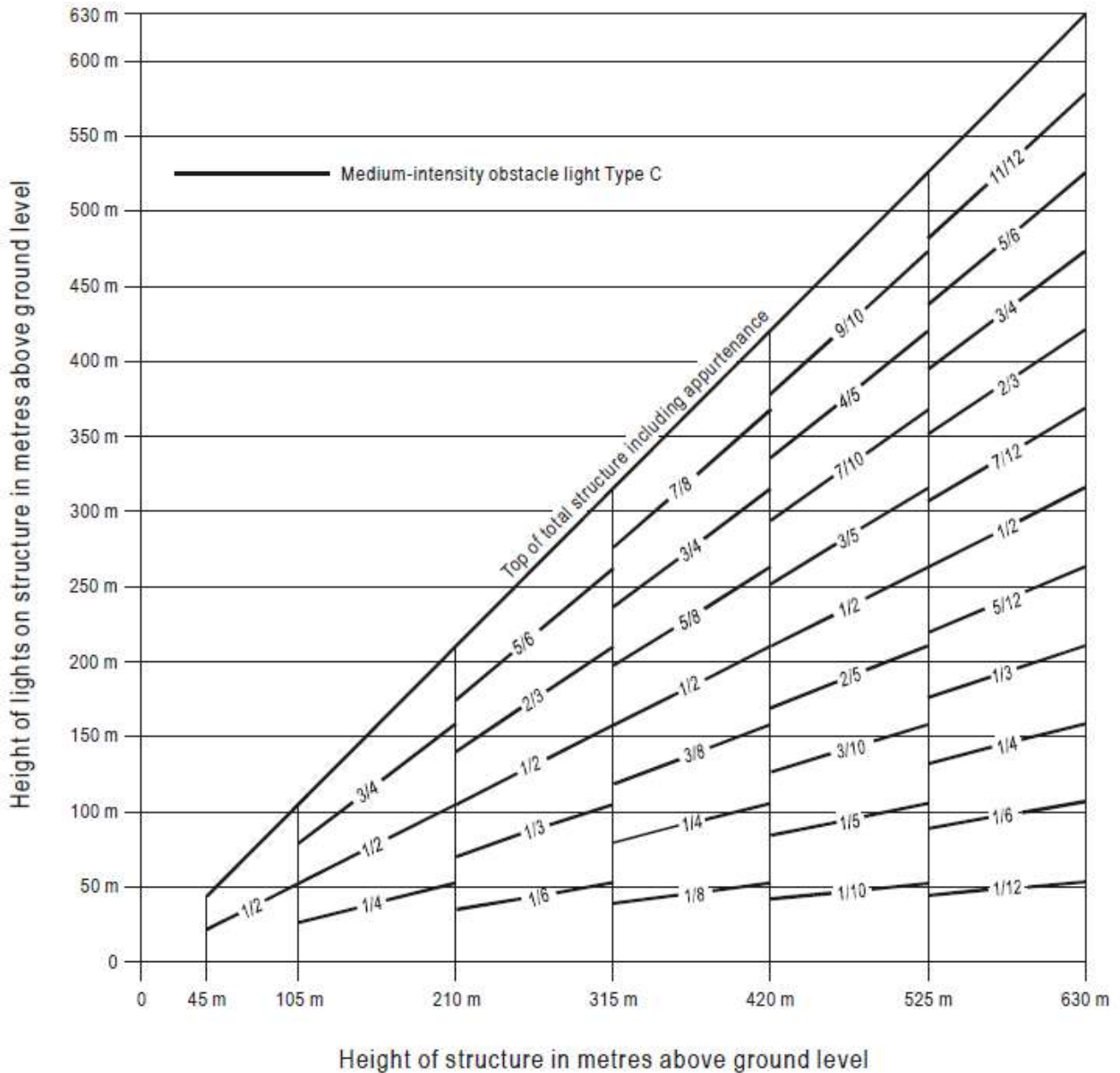
**Figure AI-1. Medium-intensity flashing-white obstacle lighting system, Type A**

## GACAR PART 139 – CERTIFICATION, AUTHORIZATION AND OPERATION OF AERODROMES

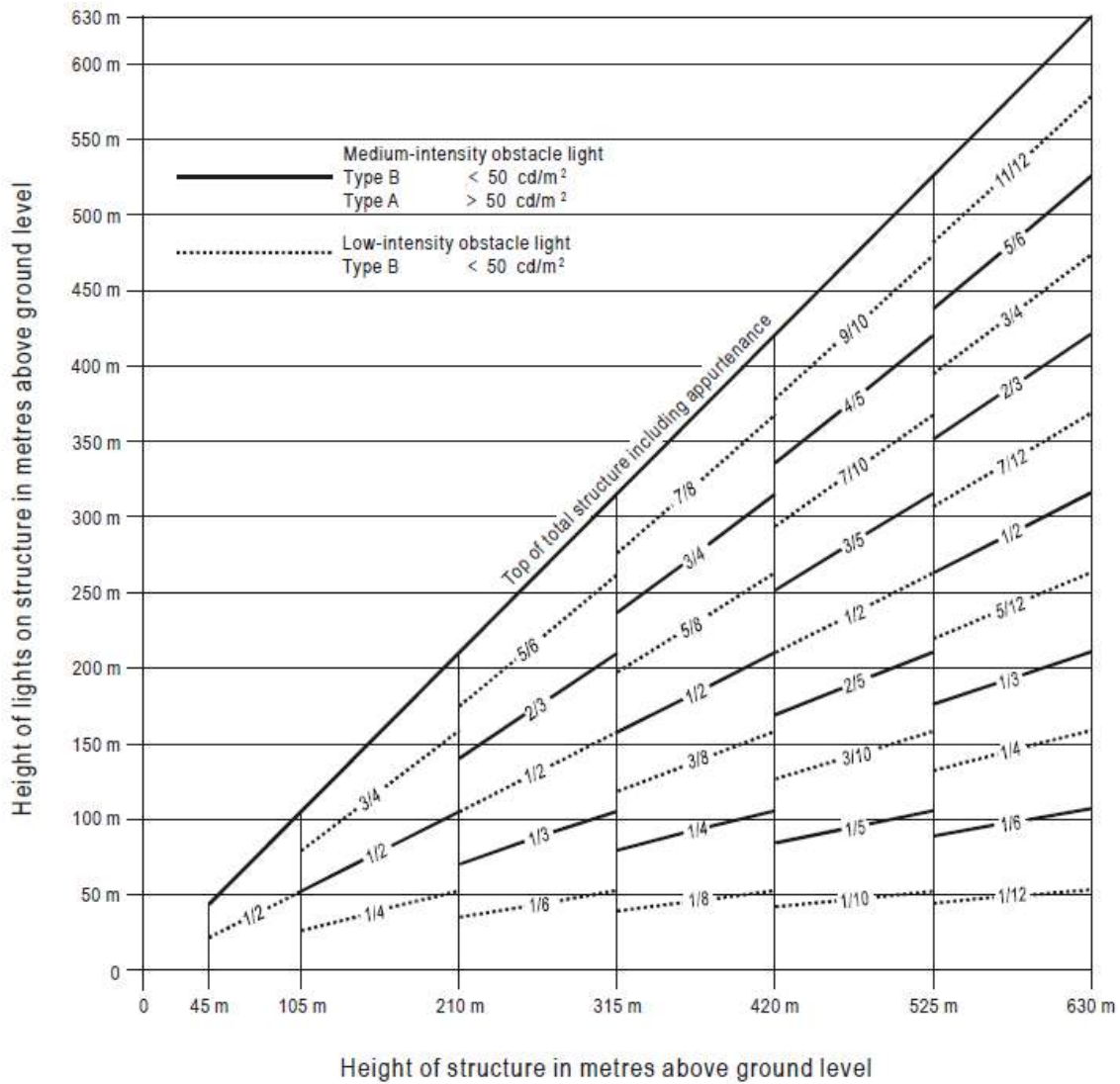


**Figure AI-2. Medium-intensity flashing-red obstacle lighting system, Type B**

## GACAR PART 139 – CERTIFICATION, AUTHORIZATION AND OPERATION OF AERODROMES



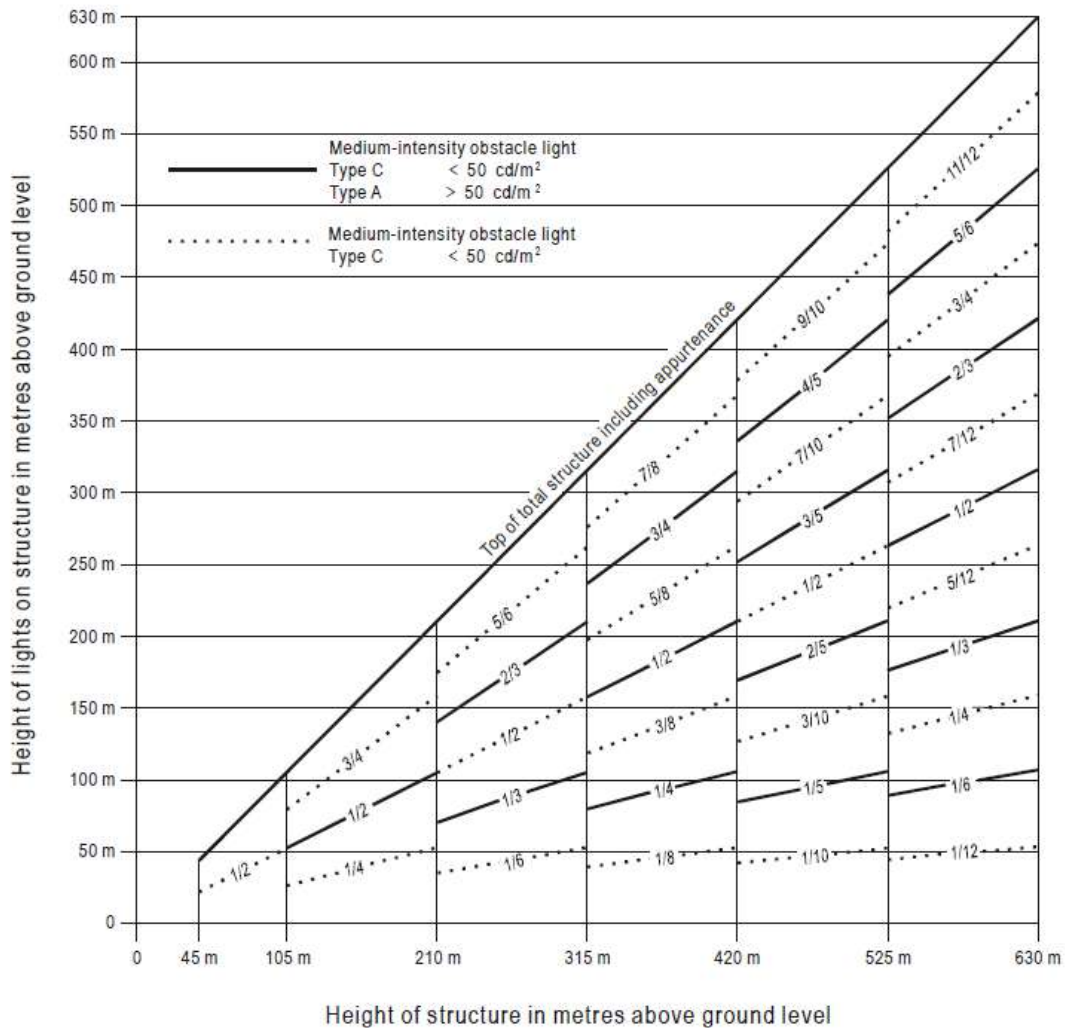
## GACAR PART 139 – CERTIFICATION, AUTHORIZATION AND OPERATION OF AERODROMES



Note. High-intensity obstacle lighting is recommended on structures with a height of more than 150 m above ground level. If medium-intensity lighting is used, marking will also be required.

**Figure AI-4. Medium-intensity dual obstacle lighting system, Type A/Type B**

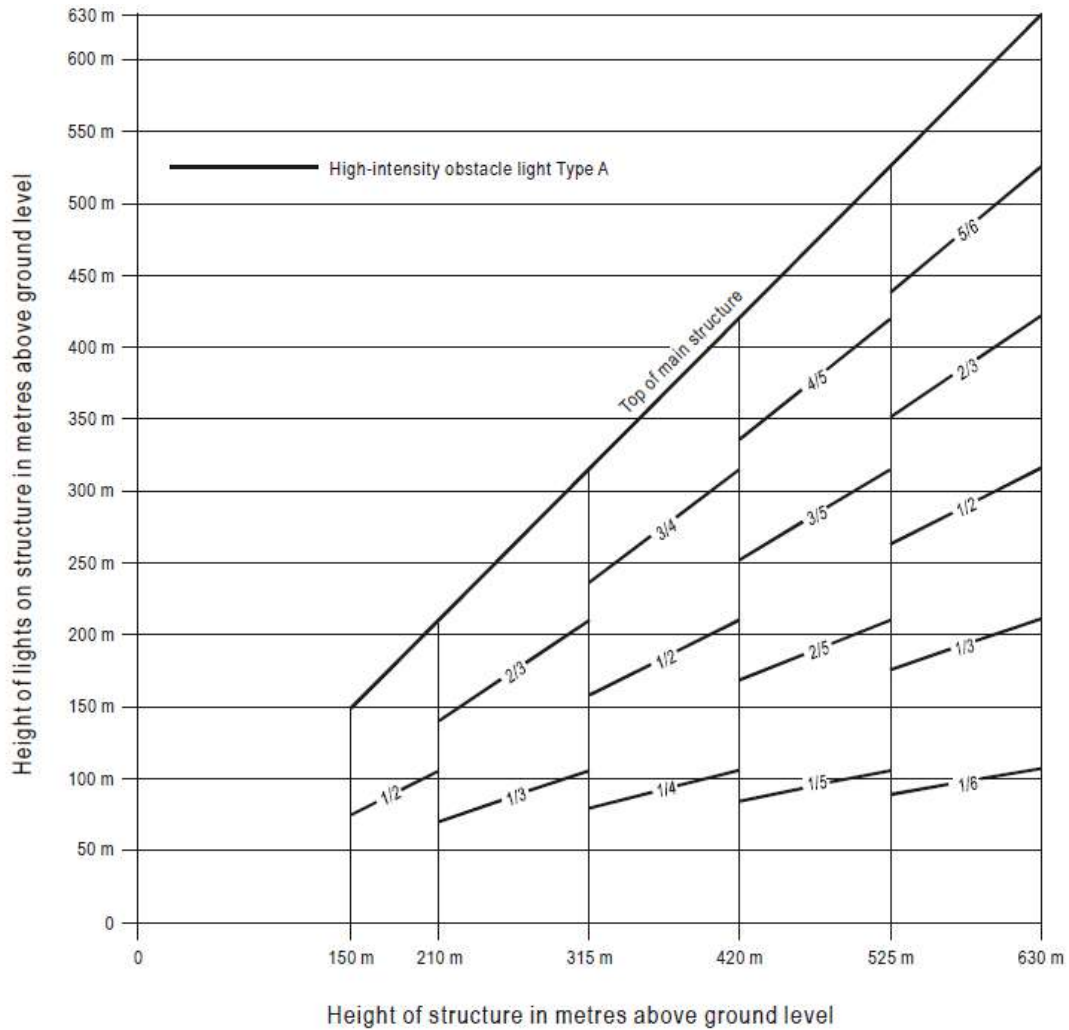
## GACAR PART 139 – CERTIFICATION, AUTHORIZATION AND OPERATION OF AERODROMES



Note. High-intensity obstacle lighting is recommended on structures with a height of more than 150 m above ground level. If medium-intensity lighting is used, marking will also be required.

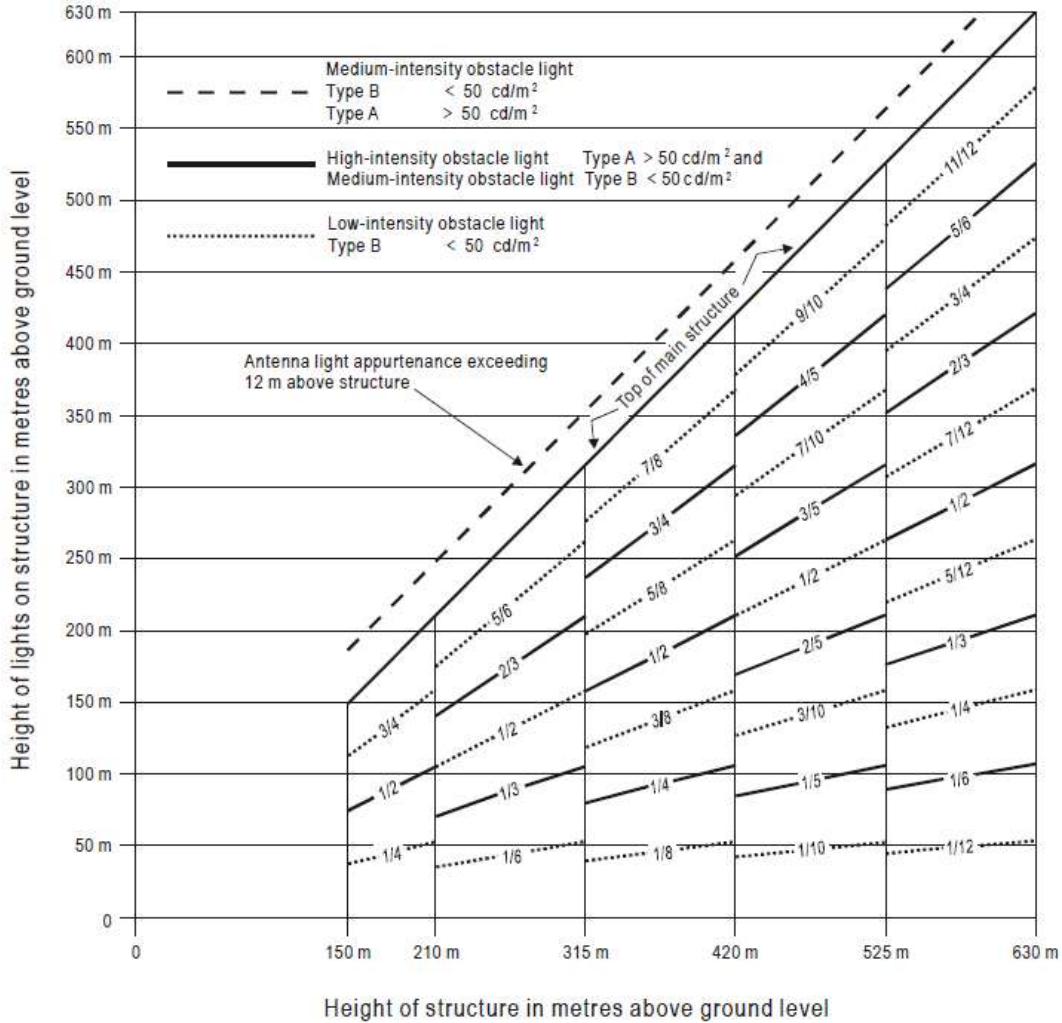
**Figure AI-5. Medium-intensity dual obstacle lighting system, Type A/Type C**

## GACAR PART 139 – CERTIFICATION, AUTHORIZATION AND OPERATION OF AERODROMES



**Figure AI-6. High-intensity flashing-white obstacle lighting system, Type A**

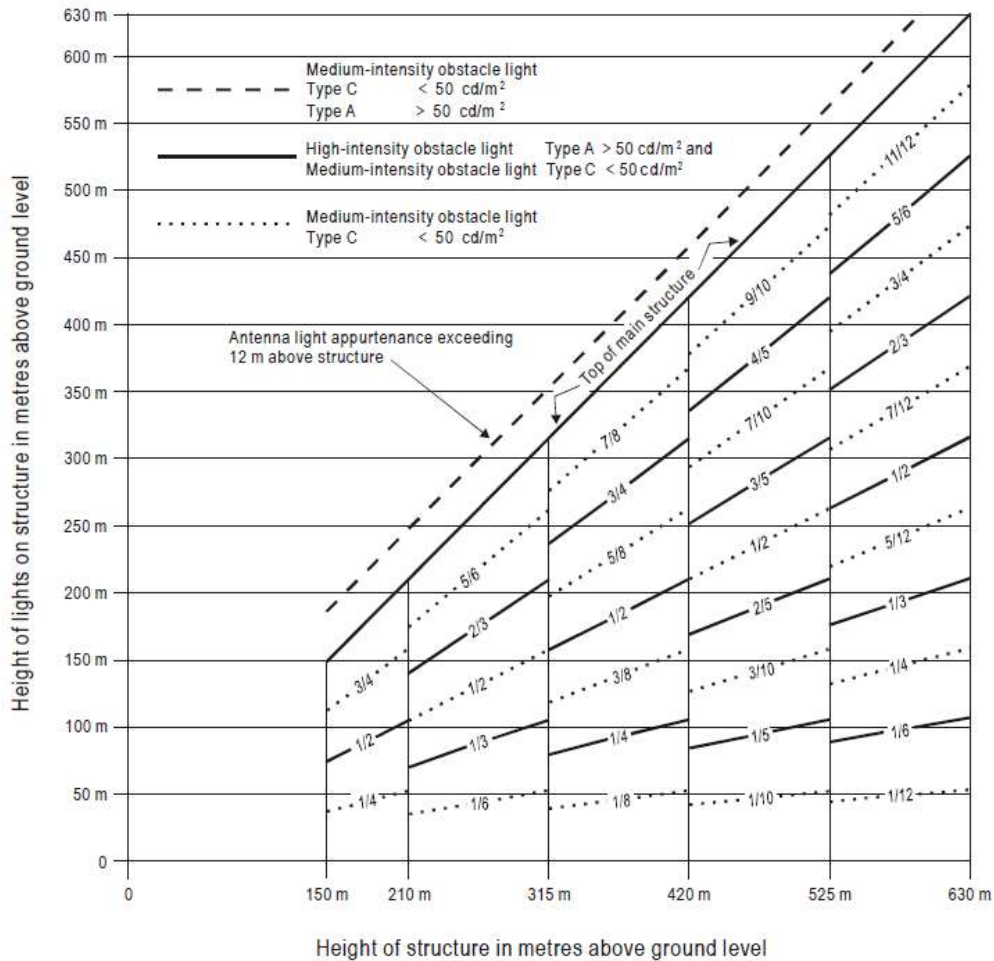
## GACAR PART 139 – CERTIFICATION, AUTHORIZATION AND OPERATION OF AERODROMES



Note. High-intensity obstacle lighting is recommended on structures with a height of more than 150 m above ground level. If medium-intensity lighting is used, marking will also be required.

**Figure AI-7. High-/medium-intensity dual obstacle lighting system, Type A/Type B**

## GACAR PART 139 – CERTIFICATION, AUTHORIZATION AND OPERATION OF AERODROMES



Note. High-intensity obstacle lighting is recommended on structures with a height of more than 150 m above ground level. If medium-intensity lighting is used, marking will also be required.

**Figure AI-8. High-/medium-intensity dual obstacle lighting system, Type A/Type C**



**GACAR PART 139 – CERTIFICATION, AUTHORIZATION AND OPERATION OF  
AERODROMES**

---

**APPENDIX J - VISUAL AIDS DENOTING RESTRICTED USE AREA**

Reserved.

**GACAR PART 139 – CERTIFICATION, AUTHORIZATION AND OPERATION OF  
AERODROMES**

---

**APPENDIX K – ELECTRICAL SYSTEM**

Reserved.

## **GACAR PART 139 – CERTIFICATION, AUTHORIZATION AND OPERATION OF AERODROMES**

---

### **APPENDIX L – AERODROME OPERATIONAL SERVICES, EQUIPMENT, AND INSTALLATIONS**

#### **APPENDIX L-1. AIRCRAFT RESCUE AND FIREFIGHTING ADDITIONAL REQUIREMENT**

The Aerodrome certificate holder must comply with the following requirements:

**1. Personnel**

a. The Aerodrome certificate holder must submit the following for acceptance:

i. The annual training program that cover at least the following subjects:

1. Airport familiarization;
2. Aircraft familiarization;
3. Rescue and firefighting personnel safety;
4. Emergency communications systems on the Aerodrome, including aircraft fire-related alarms;
5. Use of the fire hoses, nozzles, turrets and other appliances required for compliance with subpart L , § 139.903 of this part;
6. Application of the types of extinguishing agents required for compliance with subpart L, § 139.903 of this part;
7. Emergency aircraft evacuation assistance;
8. Firefighting operations;
9. Adaptation and use of structural rescue and firefighting equipment for aircraft rescue and firefighting;
10. Dangerous goods;
11. Familiarization with firefighters' duties under the Aerodrome emergency plan; and
12. Protective clothing and respiratory protection.

b. Each certified Aerodrome must employ the following RFF positions:

- i. Firefighter,
- ii. Crew Chief,
- iii. Alarm Room Operator,
- iv. Captain,

---

## **GACAR PART 139 – CERTIFICATION, AUTHORIZATION AND OPERATION OF AERODROMES**

---

- v. Duty Chief if applicable
  - vi. Dispatch Supervisor if applicable.
  - vii. Training Officer,
  - viii. Paramedic, and
  - ix. Fire Chief.
- c. The positions mentioned on Appendix L-1 -(1)-b personnel must be trained to the appropriate levels of the duty position according to appendix L-2,
- d. All Rescue and Firefighting (RFF) personnel must obtain work permit in format and manner accepted to the President.
- e. All Rescue and Firefighting (RFF) personnel must participate in at least one-live-fire drill prior to initial performance of rescue and firefighting duties and every 3 consecutive calendar months thereafter.

### **2. Training Courses:**

- a. Any training provider for RFF services must be accepted by the President.
- b. The National Fire Protection Association (NFPA) standards is considered the acceptable level of competence for RFF's curriculums.
- c. The list of courses is addressed in Appendix I-3

### **3. FATIGUE MANAGEMENT**

Each certificate holder must ensure no person is scheduled to perform RFF services for more than 24 consecutive hours of duty each seventy-two (72) hours.

### **4. Rescue and Firefighting Department Standard Operating Procedures**

Aerodrome certificate holder must submit for acceptance, RFF department Standard Operating Procedures (SOPs) for all activities of Aircraft Firefighting and Rescue Procedures, including but not limited to the following;

- a. RFF routine activities.
- b. All Emergency Pre-Plan Responses
- c. Fighting Aircraft Fires Tactic and Strategy.
- d. Accidents Involving Dangerous Goods
- e. Medical Response
- f. Mutual Aid Response / Support Activities
- g. Minimum and optimum “Operation Staffing Levels”
- h. Occupational Safety and Health Program
- i. Storage and management of fire extinguishing agents

### **5. Rescue and Fire Fighting (RFF) vehicles**

- a. RFF Vehicles maintenance must meet the following:

---

## GACAR PART 139 – CERTIFICATION, AUTHORIZATION AND OPERATION OF AERODROMES

---

- 1.The certificate holder must establish an SOP for RFF vehicles maintenance that meet manufacture maintenance program.
- 2.The certificate holder must have a qualified technician for maintain fire vehicles.

### 6. Ambulance and Medical Facilities

The availability of ambulance and medical facilities for the removal and after-care of casualties arising from an aircraft accident must receive the careful consideration of Aerodrome operator and must form part of the overall emergency plan established to deal with such emergencies.

### 7. AIRCRAFT RESCUE AND FIREFIGHTING EMERGENCY HAND SIGNALS

The following emergency hand signals are established as the minimum required for emergency communication between the ARFF incident commander/ARFF firefighters and the flight crew and/or cabin crew of the incident aircraft. ARFF emergency hand signals must be given from the left front side of the aircraft for the flight crew. In order to communicate more effectively with the cabin crew, emergency hand signals may be given by ARFF firefighters from other positions.

- A. RECOMMEND EVACUATION.** Evacuation recommended based on ARFF Incident Commander's assessment of external situation.



Arm extended from body and held horizontal with hand upraised at eye level. Execute beckoning arm motion angled backward. Non-beckoning arm held against body.

At night, same with wands.

- B. RECOMMEND STOP.**

Recommend evacuation in progress be halted. Stop aircraft movement or other activity in progress.

## GACAR PART 139 – CERTIFICATION, AUTHORIZATION AND OPERATION OF AERODROMES

---



Arms in front of head and crossed at wrists.

At night, same with wands.

### C. EMERGENCY CONTAINED.

No outside evidence of dangerous condition or “all clear.”



Arms extended outward and down at a 45-degree angle. Arms moved inward below waistline simultaneously until wrists crossed, then extended outward to starting position.

At night, same with wands

## GACAR PART 139 – CERTIFICATION, AUTHORIZATION AND OPERATION OF AERODROMES

---

### D. Fire



Move right-hand in a 'fanning' motion from shoulder to knee, while at the same time pointing with left hand to area of fire.

Night - same with wands.

**GACAR PART 139 – AERODROMES DESIGN, REGISTRATION/CERTIFICATION AND OPERATIONS**

**APPENDIX L-2. ARFF Qualifications**

| Duty Position       | Tasks Summary  | Prerequisites   | Certification Levels Required  |
|---------------------|--|---|--|
| Airport Firefighter | <ul style="list-style-type: none"> <li>Fighting fires.</li> <li>Drive and operate the fire trucks and vehicles.</li> </ul> | <ul style="list-style-type: none"> <li>Minimum 18 years old.</li> <li>High School.</li> <li>Medically and physically fit.</li> <li>Driving license</li> </ul> | <ul style="list-style-type: none"> <li>Hazardous Materials Awareness</li> <li>Hazardous Materials Operations</li> <li>Fire Fighter I</li> <li>Fire Fighter II</li> <li>Driver Operator</li> <li>Airport Firefighter</li> <li>First Aids &amp; CPR</li> </ul> |
| Paramedic           | <ul style="list-style-type: none"> <li>Provide medical treatment and evacuation.</li> </ul>                                |   | <ul style="list-style-type: none"> <li>Associate degree as Emergency Medical Technician or higher degree</li> <li>Valid License from Saudi Commission Health Specialties.</li> </ul>   |



**GACAR PART 139 – AERODROMES DESIGN, REGISTRATION/CERTIFICATION AND OPERATIONS**

**APPENDIX L-2. ARFF Qualifications**

| Duty Position                             | Tasks Summary   | Prerequisites   | Certification Levels Required   |
|---|---|---|---|
| Dispatch Supervisor / Alarm Room Operator | <ul style="list-style-type: none"> <li>Monitor alarm systems.</li> <li>Respond to calls (medical calls, fuel dispatching,)</li> </ul>             | <ul style="list-style-type: none"> <li>Minimum 18 years old.</li> <li>High School.</li> <li>Medically and physically fit.</li> </ul>                | <ul style="list-style-type: none"> <li>Telecommunications I &amp; II</li> <li>Hazmat Awareness</li> </ul>   |
| Crew Chief                                | Manage one of the fire fighting vehicles in the station.  | <ul style="list-style-type: none"> <li>Meet the qualification of Airport Firefighter.</li> <li>3 years as airport fire fighter.</li> </ul>          | <ul style="list-style-type: none"> <li>Fire Officer I</li> <li>Fire Instructor I</li> <li>Fire Inspector I</li> <li>Hazardous Materials Awareness, Technician</li> <li>Incident Safety Officer</li> </ul> |
| Station Captain                           | <ul style="list-style-type: none"> <li>Manage the main fire station.</li> <li>Ensure around the clock readiness of crew and equipment.</li> </ul> | <ul style="list-style-type: none"> <li>Meet the qualification of Airport Crew Chief.</li> <li>3 years' experience as Airport Crew Chief.</li> </ul> | <ul style="list-style-type: none"> <li>Fire Officer II</li> <li>Fire Instructor I</li> <li>Fire Inspector I</li> <li>Incident Safety Officer</li> </ul>   |

**GACAR PART 139 – AERODROMES DESIGN, REGISTRATION/CERTIFICATION AND OPERATIONS**

**APPENDIX L-2. ARFF Qualifications**

| Duty Position    | Tasks Summary   | Prerequisites   | Certification Levels Required   |
|------------------|---|---|---|
|                  |   |   | <ul style="list-style-type: none"> <li>• Hazardous Materials Incident Commander</li> </ul>  |
| Training Officer | <ul style="list-style-type: none"> <li>• Provide training courses to Fire &amp; Rescue Staff.</li> <li>• Ensure that FRS crew are up to the knowledge of their equipment and tools.</li> <li>• Ensure that proper training is administered to the FRS crew as well as to airport employees at large.</li> </ul> | <ul style="list-style-type: none"> <li>• Meet the qualification of Airport Crew Chief.</li> <li>• 5 years' experience as Airport Crew Chief or 1 year experience as Station Captain.</li> <li>• Airport fire officer Diploma</li> </ul> | <ul style="list-style-type: none"> <li>• Fire Officer III</li> <li>• Fire Instructor III</li> <li>• Fire Inspector II</li> <li>• Incident Safety Officer</li> <li>• Hazardous Materials Incident Commander</li> </ul> |

---

**GACAR PART 139 – AERODROMES DESIGN, REGISTRATION/CERTIFICATION AND OPERATIONS**

---

**APPENDIX L-2. ARFF Qualifications**

| Duty Position | Tasks Summary   | Prerequisites   | Certification Levels Required   |
|---------------|---|---|---|
| Fire Chief    | <ul style="list-style-type: none"> <li>• Establishing and effectively managing all aspects of Rescue and Firefighting Services as per the accepted Aerodrome manual and ensure compliance with GACA regulations.</li> <li>• Ensure that rescue and firefighting, polices, procedures and training fulfil the aims of the Aerodrome and meet regulatory requirements.</li> <li>• Ensure readiness of crew at all times.</li> </ul> | <ul style="list-style-type: none"> <li>• Meet the qualification of Station Captain.</li> <li>• 7 years' experience as Station Captain.</li> <li>• Airport fire officer Diploma</li> </ul> | <ul style="list-style-type: none"> <li>• Fire Officer VI</li> <li>• Fire Inspector II</li> <li>• Fire Instructor II</li> <li>• Incident Safety Officer</li> <li>• Hazardous Materials Incident Commander</li> </ul> |

**GACAR PART 139 – DESIGN, CERTIFICATION, AUTHORIZATION AND OPERATIONS: AERODROMES**

| <b>Appendix L-3. Courses</b> |            |   |                     |
|------------------------------|------------|---|---------------------|
| No                           | Code       | Courses   | References Material |
| 1                            | FF I       | Fire Fighter I  | NFPA 1001           |
| 2                            | FF II      | Fire Fighter II   | NFPA 1001           |
| 3                            | AFF        | Airport Firefighter   | NFPA 1003           |
| 4                            | DO         | Driver Operator.<br>- Driver/Operator<br>- Pumper<br>- Aircraft Rescue and Fire-Fighting Apparatus<br>- Mobile Water Supply           | NFPA 1002           |
| 5                            | HazMat I   | Hazardous Materials Awareness   | NFPA 1072           |
| 6                            | HazMat II  | Hazardous Materials Operations<br>- Operations Core<br>- OP MSC Personal Protective Equipment (6.2)<br>- OP MSC Product Control (6.6) | NFPA 1072           |
| 7                            | HazMat III | Hazardous Materials Technician  | NFPA 1072           |
| 8                            | HazMat VI  | Hazardous Materials Incident Commander  | NFPA 1072           |
| 9                            | FO I       | Fire Officer I  | NFPA 1021           |
| 10                           | FO II      | Fire Officer II   | NFPA 1021           |
| 11                           | FO III     | Fire Officer III  | NFPA 1021           |
| 12                           | FO VI      | Fire Officer VI   | NFPA 1021           |
| 13                           | FI I       | Fire Instructor I   | NFPA 1041           |
| 14                           | FI II      | Fire Instructor II  | NFPA 1041           |
| 15                           | FT III     | Fire Instructor III   | NFPA 1041           |
| 16                           | FP I       | Fire Inspector I  | NFPA 1031           |
| 17                           | FP II      | Fire Inspector II   | NFPA 1031           |
| 18                           | FP III     | Fire Inspector III  | NFPA 1031           |

---

**GACAR PART 139 – DESIGN, CERTIFICATION, AUTHORIZATION AND OPERATIONS: AERODROMES**

---

| <b>Appendix L-3. Courses</b> |            |                                   |                     |
|------------------------------|------------|-----------------------------------|---------------------|
| No                           | Code       | Courses                           | References Material |
| 19                           | PE         | Plan Examiner                     | NFPA 1031           |
| 20                           | Tele I     | Telecommunications I              | NFPA 1061           |
| 21                           | Tele II    | Telecommunications II             | NFPA 1061           |
| 22                           | ISO        | Incident Safety Officer           | NFPA 1026           |
| 23                           | AEP        | Aerodrome Emergency Plan          | GACAR139            |
| 24                           | GACAR139-1 | Working with GACAR 139: Aerodrome | GACAR139            |
| 25                           | GACAR138-1 | Working with GACAR 138: Heliports | GACAR138            |

---

## GACAR PART 139 – DESIGN, CERTIFICATION, AUTHORIZATION AND OPERATIONS: AERODROMES

---

### Appendix L-4: RESCUE AND FIREFIGHTING REQUIREMENT FOR AUTHORIZED AERODROMES

- (a) RFF Requirement For Private Aerodrome And Flight Training Aerodrome.
- (1) The airport operator must submit a service level agreement to provide firefighting and rescue services at the airport during the operating hours stipulated in the airport operating manual to ensure the achievement of the required level of safety standards.
  - (2) The airport operator must submit a study to complete the required response time for fire engines.
  - (3) Airport operators must submit an emergency response plan provide the coordination of the actions to be taken in an emergency occurring at an airport or in its vicinity.
- (b) RFF Requirement For General Purpose Aerodrome.
- (1) General Purpose Aerodromes used for recreation, aerial work, or air shows require a heightened level of Rescue and fire fighting services (RFF) preparedness and response. The following factors are Instructions to ARFF services which must be considered but not limited to:
    - (i) The Exhibition organizer must provide Rescue and firefighting equipment and services during the event.
    - (ii) The level of protection to be provided for rescue and firefighting must be based on the overall length of the longest aircraft participation in the event and in accordance with the GACAR 139 (139.903) table L-1.
    - (iii) Extinguishing agents must be ready for use within the response time according to the GACAR 139 (139.903) table L-2,
    - (iv) RFF personnel must be staged to respond immediately to any incident or accident.
    - (v) During the period of the event, RFF personnel must have personal protective equipment (PPE) donned and be ready to respond.
    - (vi) Vehicle engines must be running throughout the entire active flying portion of the event.
    - (vii) ARFF vehicles assigned to an events must not be positioned behind the crowd line.

---

**GACAR PART 139 – DESIGN, CERTIFICATION, AUTHORIZATION AND OPERATIONS: AERODROMES**

---

- (viii) Hands on training, must be provided to enable them to perform their duties in an effective manner.
- (A) A written or graphic illustration of the event area must be presented to RFF personal during the pre- event safety briefing.
  - (B) Prior to the beginning of event flight operations, RFF personal deployed in support of the event must make themselves available to meet with the pilot-in-command of each aircraft participating in the event to discuss emergency extraction, canopy release, fuel shutoff, master switch on/off switch and aircraft lift points.
- (2) The Exhibition organizer must provide emergency response procedures during the period of the event.

---

**GACAR PART 139 – DESIGN, CERTIFICATION, AUTHORIZATION AND  
OPERATIONS: AERODROMES**

---

**APPENDIX M – AERODROME MAINTENANCE**

Reserved.



---

**GACAR PART 139 – DESIGN, CERTIFICATION, AUTHORIZATION AND OPERATIONS: AERODROMES**

---

**REFERENCES AND GUIDANCE MATERIAL**

ICAO DOCUMENTS RELATED TO THIS GACAR

ICAO 14 Volume I, 9<sup>th</sup> Edition, July 2022.

Advanced Surface Movement Guidance and Control Systems (A-SMGCS) Manual (Doc 9830)

Aerodrome Design Manual (Doc 9157)

Part 1 — Runways

Part 2 — Taxiways, Aprons and Holding Bays

Part 3 — Pavements

Part 4 — Visual Aids

Part 5 — Electrical Systems

Part 6 — Frangibility

Aeronautical Information Services Manual (Doc 8126)

Aeroplane Performance Manual (Doc 10064)

Aircraft Type Designators (Doc 8643)

Airport Planning Manual (Doc 9184)

Part 1 — Master Planning

Part 2 — Land Use and Environmental Control

Part 3 — Guidelines for Consultant/Construction Services

Airport Services Manual (Doc 9137)

---

**GACAR PART 139 – DESIGN, CERTIFICATION, AUTHORIZATION AND OPERATIONS: AERODROMES**

---

Part 1 — Rescue and Fire Fighting

Part 2 — Pavement Surface Conditions

Part 3 — Wildlife Control and Reduction

Part 5 — Removal of Disabled Aircraft

Part 6 — Control of Obstacles

Part 7 — Airport Emergency Planning

Part 8 — Airport Operational Services

Part 9 — Airport Maintenance Practices

Air Traffic Services Planning Manual (Doc 9426)

Airworthiness Manual (Doc 9760)

Guidance on the Balanced Approach to Aircraft Noise Management (Doc 9829)

Aerodrome Manual (Doc 9261)

Human Factors Training Manual (Doc 9683)

Manual of Aircraft Ground De-icing/Anti-icing Operations (Doc 9640)

Manual of All-Weather Operations (Doc 9365)

Manual of Surface Movement Guidance and Control Systems (SMGCS) (Doc 9476)

Manual on Certification of Aerodromes (Doc 9774)

Manual on Laser Emitters and Flight Safety (Doc 9815)

Manual on Simultaneous Operations on Parallel or Near-Parallel Instrument Runways (SOIR) (Doc 9643)

Manual on the ICAO Bird Strike Information System (IBIS) (Doc 9332)

Procedures for Air Navigation Services — Aerodromes (PANS-Aerodromes) (Doc 9981)

---

**GACAR PART 139 – DESIGN, CERTIFICATION, AUTHORIZATION AND OPERATIONS: AERODROMES**

---

Procedures for Air Navigation Services — Aeronautical Information Management (PANS-AIM) (Doc 10066)

Procedures for Air Navigation Services — Aircraft Operations (PANS-OPS) (Doc 8168)

Volume I — Flight Procedures

Volume II — Construction of Visual and Instrument Flight Procedures

Procedures for Air Navigation Services — Air Traffic Management (PANS-ATM) (Doc 4444)

Safety Management Manual (SMM) (Doc 9859)

Stolport Manual (Doc 9150)

World Geodetic System — 1984 (WGS-84) Manual (Doc 9674)

Assessment, Measurement and Reporting of Runway Surface Conditions (Cir 355)

New Larger Aeroplanes — Infringement of the Obstacle Free Zone: Operational Measures and Aeronautical Study (Cir 301)

New Larger Aeroplanes – Infringement of the Obstacle Free Zone: Collision Risk Model and Aeronautical Study (Cir 345)

National Fire Protection Association Code

ACI Apron Markings and Signs Handbook